

# STARPOWER

SEMICONDUCTOR™

## IGBT

### GD50HFT60C1S

Molding Type Module

600V/50A 2 in one-package

#### General Description

STARPOWER IGBT Power Module provides ultra low conduction loss as well as short circuit ruggedness. They are designed for the applications such as UPS and SMPS.



#### Features

- Low  $V_{CE(sat)}$  trench IGBT technology
- 5 $\mu$ s short circuit capability
- $V_{CE(sat)}$  with positive temperature coefficient
- Maximum junction temperature 175 °C
- Low inductance case
- Fast & soft reverse recovery anti-parallel FWD
- Isolated copper baseplate using DBC technology

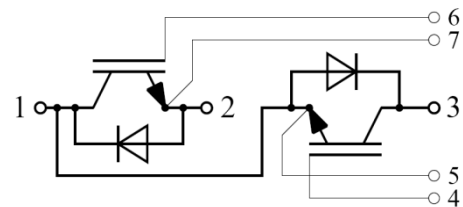

Equivalent Circuit Schematic

#### Typical Applications

- Electronic welders
- Switching mode power supplies
- Uninterruptible power supply

**Absolute Maximum Ratings**  $T_C=25^{\circ}\text{C}$  unless otherwise noted

Symbol	Description	GD50HFT60C1S	Units
$V_{CES}$	Collector-Emitter Voltage	600	V
$V_{GES}$	Gate-Emitter Voltage	$\pm 20$	V
$I_C$	Collector Current @ $T_C=25^{\circ}\text{C}$	85	A
	@ $T_C=80^{\circ}\text{C}$	50	
$I_{CM(1)}$	Pulsed Collector Current $t_p=1\text{ms}$	100	A
$I_F$	Diode Continuous Forward Current @ $T_C=80^{\circ}\text{C}$	50	A
$I_{FM(1)}$	Diode Maximum Forward Current $t_p=1\text{ms}$	100	A
$P_D$	Maximum Power Dissipation @ $T_j=175^{\circ}\text{C}$	208	W
$T_{jmax}$	Maximum Junction Temperature	175	$^{\circ}\text{C}$
$T_{STG}$	Storage Temperature Range	-40 to +125	$^{\circ}\text{C}$
$V_{ISO}$	Isolation Voltage RMS, $f=50\text{Hz}$ , $t=1\text{min}$	4000	V
Mounting Torque	Power Terminal Screw:M5 Mounting Screw:M6	2.5 to 5.0 3.0 to 5.0	N.m

Notes:

(1) Repetitive rating: Pulse width limited by max. junction temperature

**Electrical Characteristics of IGBT**  $T_C=25^{\circ}\text{C}$  unless otherwise noted**Off Characteristics**

Symbol	Parameter	Test Conditions	Min.	Typ.	Max.	Units
$V_{(BR)CES}$	Collector-Emitter Breakdown Voltage	$T_j=25^{\circ}\text{C}$	600			V
$I_{CES}$	Collector Cut-Off Current	$V_{CE}=V_{CES}$ , $V_{GE}=0\text{V}$ , $T_j=25^{\circ}\text{C}$			1.0	mA
$I_{GES}$	Gate-Emitter Leakage Current	$V_{GE}=V_{GES}$ , $V_{CE}=0\text{V}$ , $T_j=25^{\circ}\text{C}$			400	nA

**On Characteristics**

Symbol	Parameter	Test Conditions	Min.	Typ.	Max.	Units
$V_{GE(th)}$	Gate-Emitter Threshold Voltage	$I_C=1.4\text{mA}$ , $V_{CE}=V_{GE}$ , $T_j=25^{\circ}\text{C}$	4.0	4.9	6.5	V
$V_{CE(sat)}$	Collector to Emitter Saturation Voltage	$I_C=50\text{A}$ , $V_{GE}=15\text{V}$ , $T_j=25^{\circ}\text{C}$		1.65	2.10	V
		$I_C=50\text{A}$ , $V_{GE}=15\text{V}$ , $T_j=175^{\circ}\text{C}$		2.05		

**Switching Characteristics**

Symbol	Parameter	Test Conditions	Min.	Typ.	Max.	Units
$t_{d(on)}$	Turn-On Delay Time	$V_{CC}=300V, I_C=50A,$ $R_G=3.3\Omega, V_{GE}=\pm 15V,$ $T_j=25^\circ C$		58		ns
$t_r$	Rise Time			31		ns
$t_{d(off)}$	Turn-Off Delay Time			80		ns
$t_f$	Fall Time			100		ns
$E_{on}$	Turn-On Switching Loss			0.41		mJ
$E_{off}$	Turn-Off Switching Loss			0.42		mJ
$t_{d(on)}$	Turn-On Delay Time	$V_{CC}=300V, I_C=50A,$ $R_G=3.3\Omega, V_{GE}=\pm 15V,$ $T_j=125^\circ C$		64		ns
$t_r$	Rise Time			37		ns
$t_{d(off)}$	Turn-Off Delay Time			90		ns
$t_f$	Fall Time			117		ns
$E_{on}$	Turn-On Switching Loss			0.69		mJ
$E_{off}$	Turn-Off Switching Loss			0.69		mJ
$C_{ies}$	Input Capacitance	$V_{CE}=30V, f=1MHz,$ $V_{GE}=0V$		3.03		nF
$C_{oes}$	Output Capacitance			0.25		nF
$C_{res}$	Reverse Transfer Capacitance			0.09		nF
$I_{SC}$	SC Data	$T_P \leq 5\mu s, V_{GE}=15V,$ $T_j=125^\circ C, V_{CC}=360V,$ $V_{CEM} \leq 600V$		450		A
$L_{CE}$	Stray Inductance				30	nH
$R_{CC'+EE'}$	Module Lead Resistance, Terminal To Chip			0.75		m $\Omega$

**Electrical Characteristics of DIODE**  $T_C=25^\circ C$  unless otherwise noted

Symbol	Parameter	Test Conditions	Min.	Typ.	Max.	Units	
$V_F$	Diode Forward Voltage	$I_F=50A$	$T_j=25^\circ C$		1.35	1.75	V
			$T_j=125^\circ C$		1.37		
$Q_r$	Recovered Charge	$I_F=50A,$	$T_j=25^\circ C$		2.3		$\mu C$
			$T_j=125^\circ C$		4.3		
$I_{RM}$	Peak Reverse Recovery Current	$V_R=300V,$ $R_G=3.3\Omega,$	$T_j=25^\circ C$		33		A
			$T_j=125^\circ C$		58		
$E_{rec}$	Reverse Recovery Energy	$V_{GE}=-15V$	$T_j=25^\circ C$		0.56		mJ
			$T_j=125^\circ C$		1.11		

**Thermal Characteristics**

<b>Symbol</b>	<b>Parameter</b>	<b>Typ.</b>	<b>Max.</b>	<b>Units</b>
$R_{\theta JC}$	Junction-to-Case (per IGBT)		0.72	K/W
$R_{\theta JC}$	Junction-to-Case (per DIODE)		1.02	K/W
$R_{\theta CS}$	Case-to-Sink (Conductive grease applied)	0.05		K/W
Weight	Weight of Module	150		g

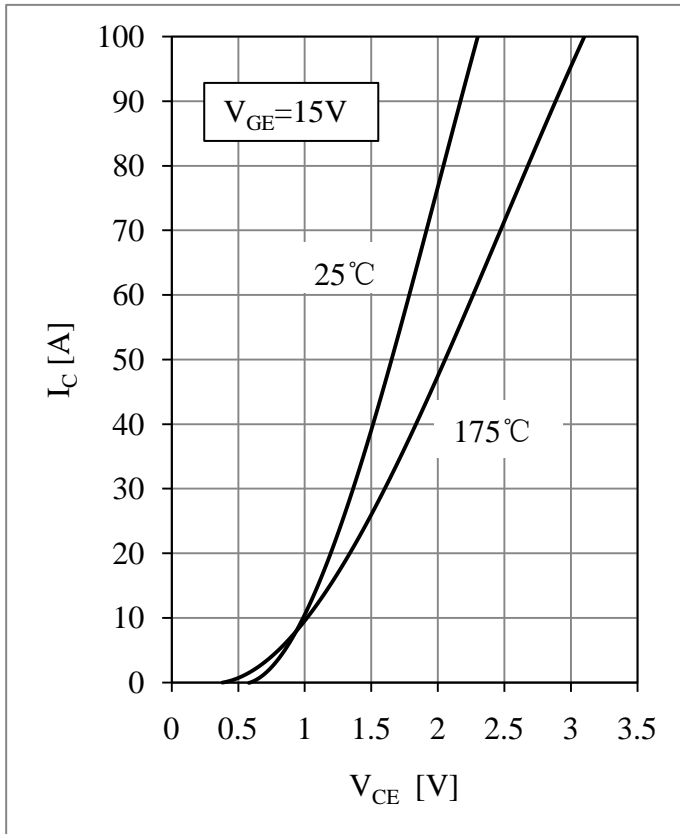

Fig 1. IGBT Output Characteristics

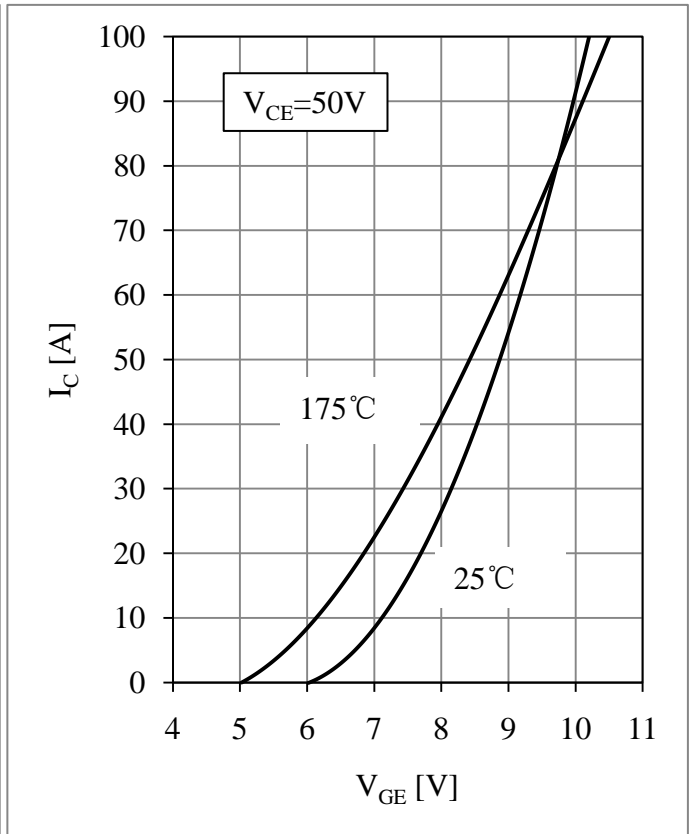

Fig 2. IGBT Transfer Characteristics

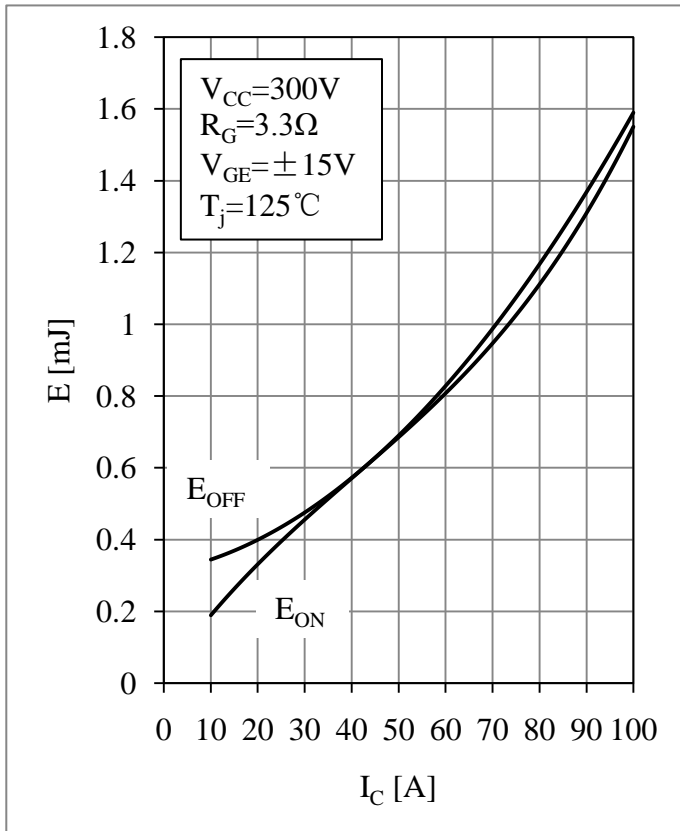

Fig 3. IGBT Switching Loss vs.  $I_C$

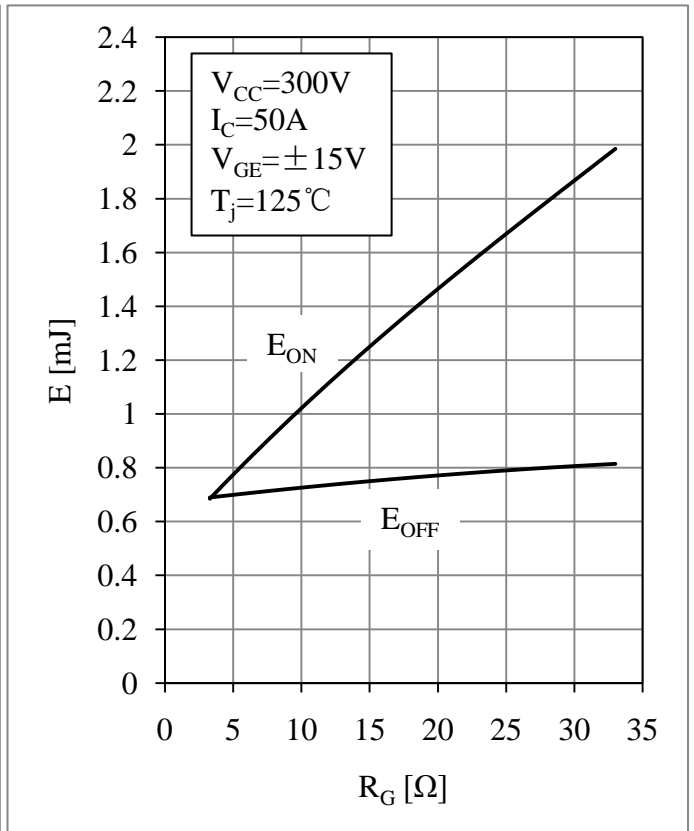

Fig 4. IGBT Switching Loss vs.  $R_G$

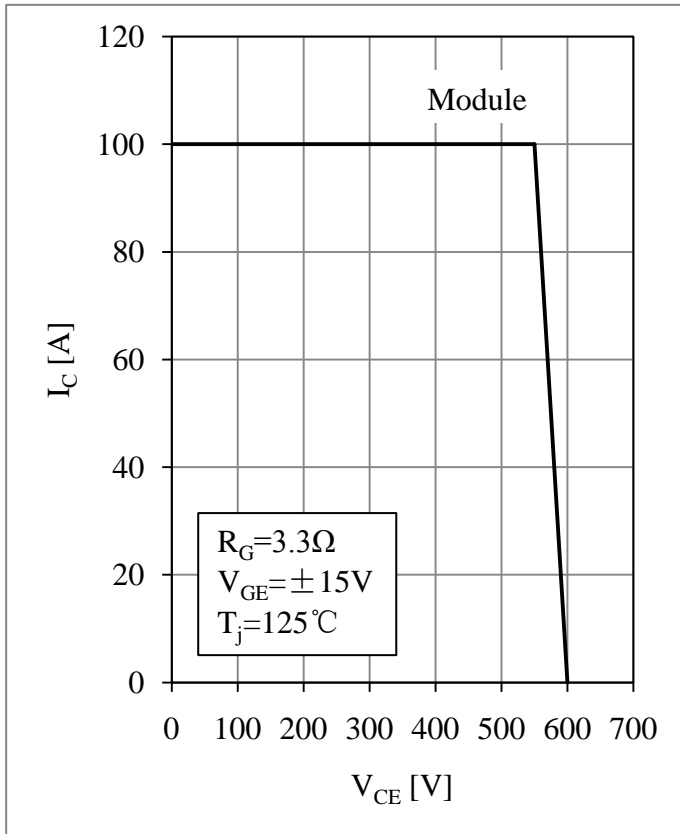

Fig 5. RBSOA

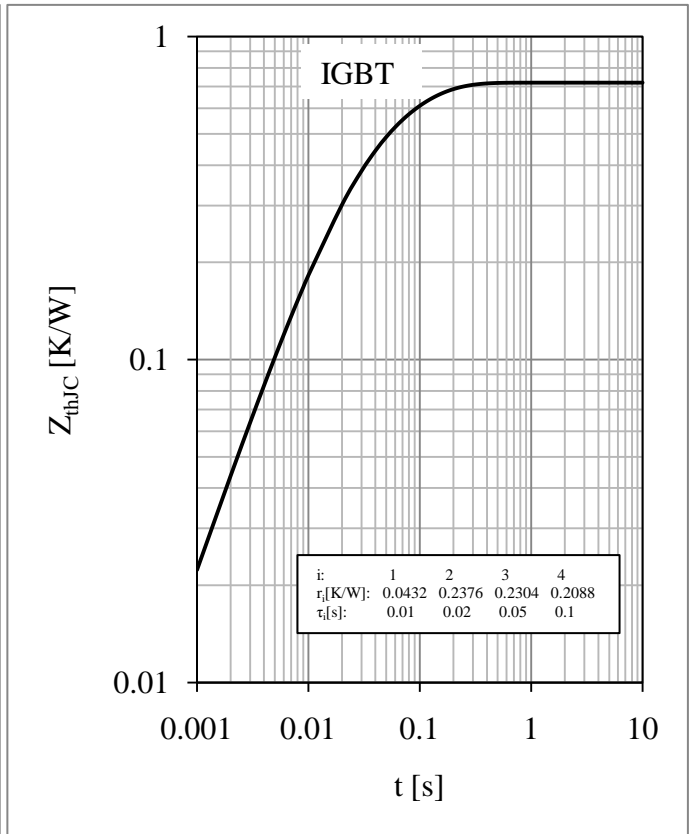

Fig 6. IGBT Transient Thermal Impedance

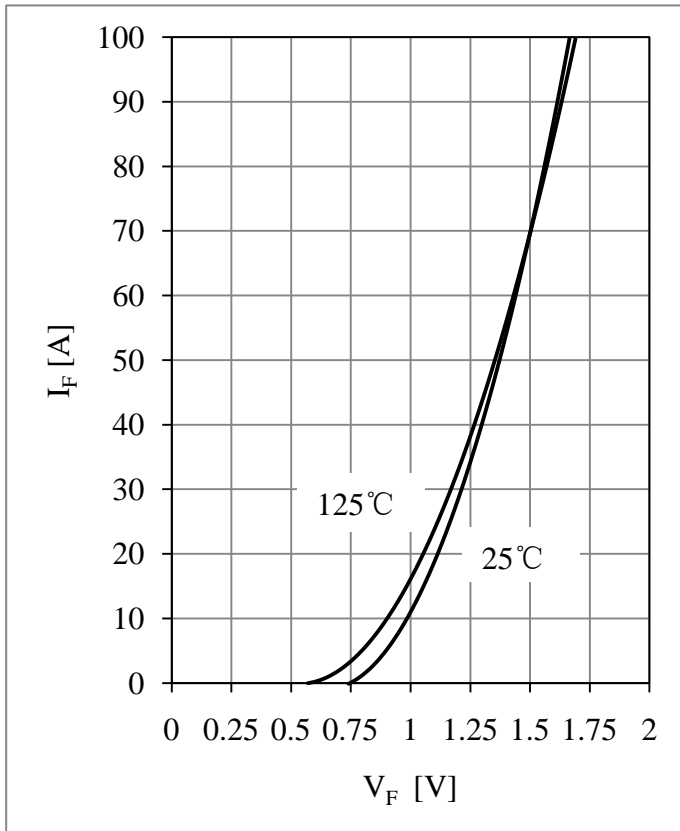

Fig 7. Diode Forward Characteristics

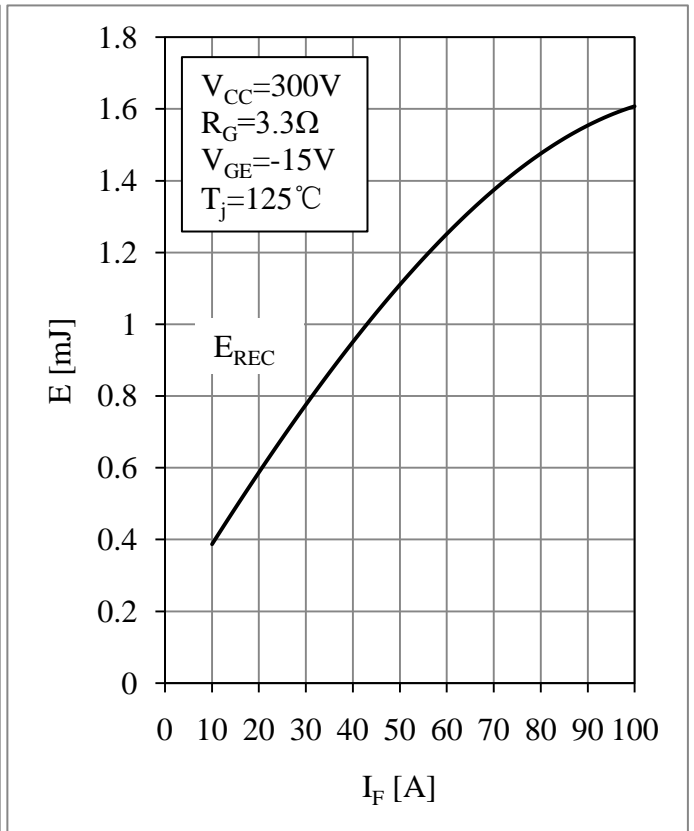

Fig 8. Diode Switching Loss vs.  $I_F$

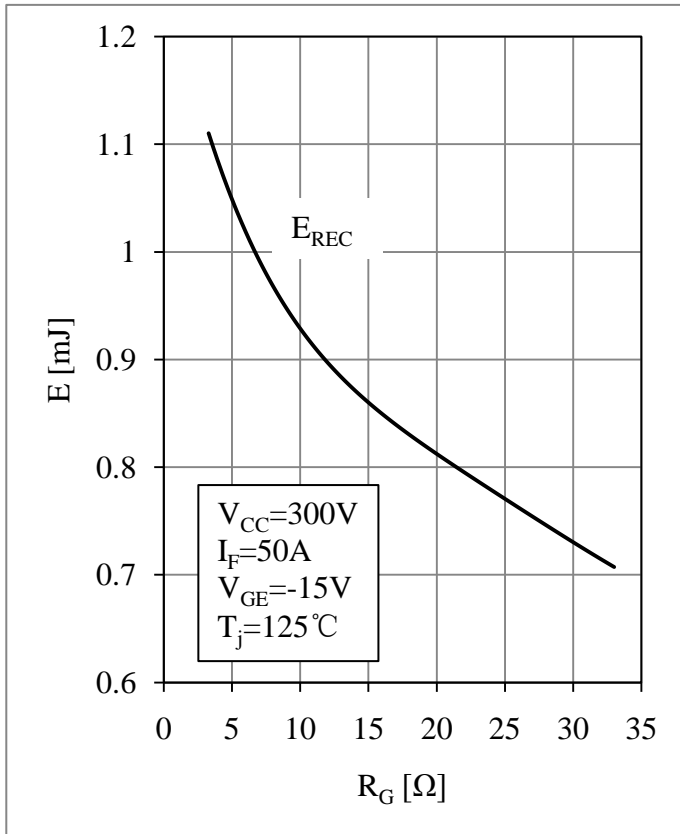

Fig 9. Diode Switching Loss vs.  $R_G$

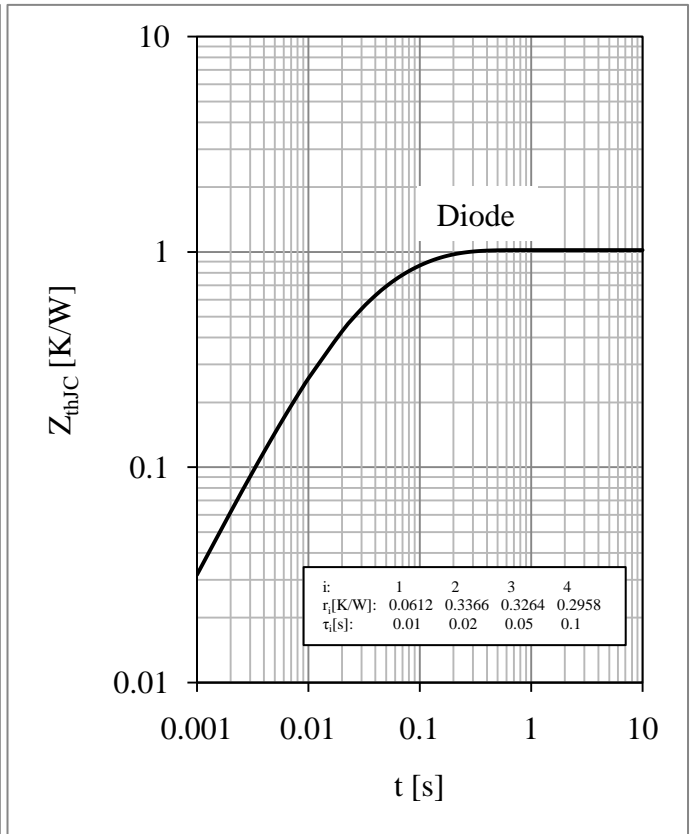
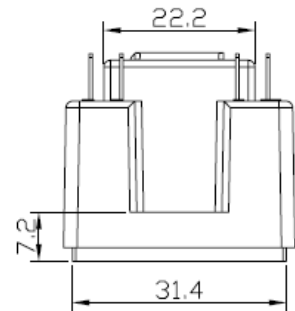
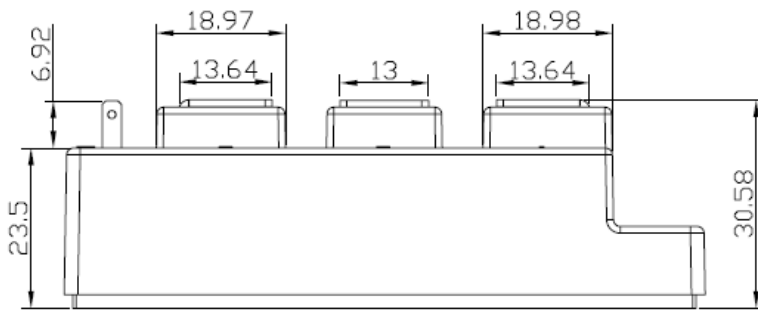
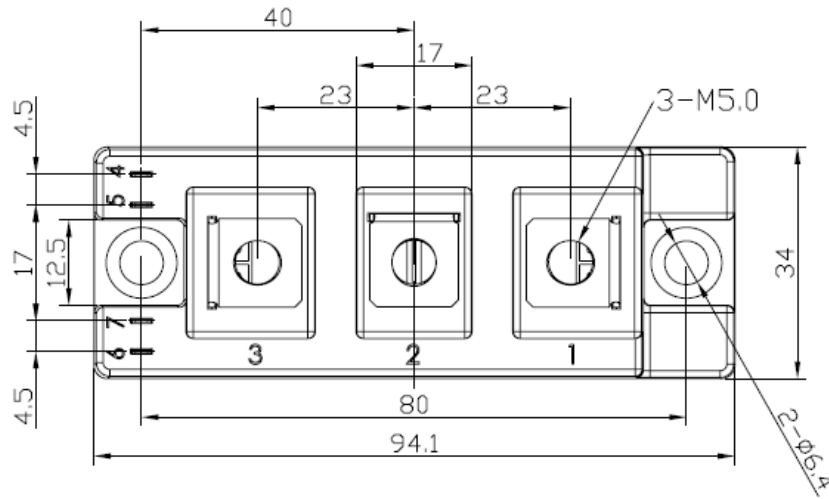

Fig 10. Diode Transient Thermal Impedance

### Package Dimension

Dimensions in Millimeters





## Terms and Conditions of Usage

The data contained in this product datasheet is exclusively intended for technically trained staff. you and your technical departments will have to evaluate the suitability of the product for the intended application and the completeness of the product data with respect to such application.

This product data sheet is describing the characteristics of this product for which a warranty is granted. Any such warranty is granted exclusively pursuant the terms and conditions of the supply agreement. There will be no guarantee of any kind for the product and its characteristics.

Should you require product information in excess of the data given in this product data sheet or which concerns the specific application of our product, please contact the sales office, which is responsible for you (see [www.powersemi.cc](http://www.powersemi.cc)), For those that are specifically interested we may provide application notes.

Due to technical requirements our product may contain dangerous substances. For information on the types in question please contact the sales office, which is responsible for you.

Should you intend to use the Product in aviation applications, in health or live endangering or life support applications, please notify.

If and to the extent necessary, please forward equivalent notices to your customers.  
Changes of this product data sheet are reserved.