

STARPOWER

SEMICONDUCTOR

IGBT

GD50FSX65L2S

650V/50A 6 in one-package

General Description

STARPOWER IGBT Power Module provides ultra low conduction loss as well as short circuit ruggedness. They are designed for the applications such as general inverters and UPS.

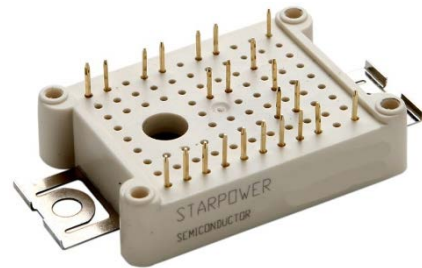

Features

- Low $V_{CE(sat)}$ Trench IGBT technology
- 6 μ s short circuit capability
- $V_{CE(sat)}$ with positive temperature coefficient
- Maximum junction temperature 175°C
- Low inductance case
- Fast & soft reverse recovery anti-parallel FWD
- Isolated heatsink using DBC technology

Typical Applications

- Inverter for motor drive
- AC and DC servo drive amplifier
- Uninterruptible power supply

Equivalent Circuit Schematic

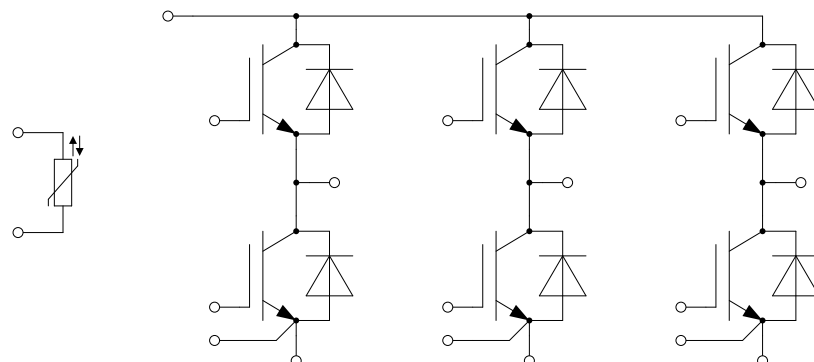

Absolute Maximum Ratings $T_C=25^{\circ}\text{C}$ unless otherwise noted**IGBT**

| Symbol | Description | Value | Unit |
|-----------|---|----------|------|
| V_{CES} | Collector-Emitter Voltage | 650 | V |
| V_{GES} | Gate-Emitter Voltage | ± 20 | V |
| I_C | Collector Current @ $T_C=25^{\circ}\text{C}$ | 89 | A |
| | @ $T_C=100^{\circ}\text{C}$ | 50 | A |
| I_{CM} | Pulsed Collector Current $t_p=1\text{ms}$ | 100 | A |
| P_D | Maximum Power Dissipation @ $T_j=175^{\circ}\text{C}$ | 258 | W |

Diode

| Symbol | Description | Value | Unit |
|-----------|--|-------|------|
| V_{RRM} | Repetitive Peak Reverse Voltage | 650 | V |
| I_F | Diode Continuous Forward Current | 50 | A |
| I_{FM} | Diode Maximum Forward Current $t_p=1\text{ms}$ | 100 | A |

Module

| Symbol | Description | Value | Unit |
|------------|--|-------------|--------------------|
| T_{jmax} | Maximum Junction Temperature | 175 | $^{\circ}\text{C}$ |
| T_{jop} | Operating Junction Temperature | -40 to +150 | $^{\circ}\text{C}$ |
| T_{STG} | Storage Temperature Range | -40 to +125 | $^{\circ}\text{C}$ |
| V_{ISO} | Isolation Voltage RMS, $f=50\text{Hz}$, $t=1\text{min}$ | 2500 | V |

IGBT Characteristics $T_C=25^\circ\text{C}$ unless otherwise noted

| Symbol | Parameter | Test Conditions | Min. | Typ. | Max. | Unit | |
|---------------|---|---|---|------|------|---------------|----|
| $V_{CE(sat)}$ | Collector to Emitter Saturation Voltage | $I_C=50\text{A}, V_{GE}=15\text{V}, T_j=25^\circ\text{C}$ | | 1.45 | 1.90 | V | |
| | | $I_C=50\text{A}, V_{GE}=15\text{V}, T_j=125^\circ\text{C}$ | | 1.60 | | | |
| | | $I_C=50\text{A}, V_{GE}=15\text{V}, T_j=150^\circ\text{C}$ | | 1.70 | | | |
| $V_{GE(th)}$ | Gate-Emitter Threshold Voltage | $I_C=0.80\text{mA}, V_{CE}=V_{GE}, T_j=25^\circ\text{C}$ | 5.1 | 5.8 | 6.5 | V | |
| I_{CES} | Collector Cut-Off Current | $V_{CE}=V_{CES}, V_{GE}=0\text{V}, T_j=25^\circ\text{C}$ | | | 1.0 | mA | |
| I_{GES} | Gate-Emitter Leakage Current | $V_{GE}=V_{GES}, V_{CE}=0\text{V}, T_j=25^\circ\text{C}$ | | | 400 | nA | |
| R_{Gint} | Internal Gate Resistance | | | 0 | | Ω | |
| C_{ies} | Input Capacitance | $V_{CE}=25\text{V}, f=1\text{MHz}, V_{GE}=0\text{V}$ | | 5.80 | | nF | |
| C_{res} | Reverse Transfer Capacitance | | | 0.11 | | nF | |
| Q_G | Gate Charge | $V_{GE}=-15\dots+15\text{V}$ | | 0.35 | | μC | |
| $t_{d(on)}$ | Turn-On Delay Time | $V_{CC}=300\text{V}, I_C=50\text{A}, R_G=6.8\Omega, V_{GE}=\pm 15\text{V}, T_j=25^\circ\text{C}$ | | 18 | | ns | |
| t_r | Rise Time | | | 15 | | ns | |
| $t_{d(off)}$ | Turn-Off Delay Time | | | 136 | | ns | |
| t_f | Fall Time | | | 24 | | ns | |
| E_{on} | Turn-On Switching Loss | | | 0.32 | | mJ | |
| E_{off} | Turn-Off Switching Loss | | | 0.96 | | mJ | |
| $t_{d(on)}$ | Turn-On Delay Time | | $V_{CC}=300\text{V}, I_C=50\text{A}, R_G=6.8\Omega, V_{GE}=\pm 15\text{V}, T_j=125^\circ\text{C}$ | | 18 | | ns |
| t_r | Rise Time | | | | 18 | | ns |
| $t_{d(off)}$ | Turn-Off Delay Time | | | 152 | | ns | |
| t_f | Fall Time | | | 32 | | ns | |
| E_{on} | Turn-On Switching Loss | | | 0.46 | | mJ | |
| E_{off} | Turn-Off Switching Loss | | | 1.28 | | mJ | |
| $t_{d(on)}$ | Turn-On Delay Time | $V_{CC}=300\text{V}, I_C=50\text{A}, R_G=6.8\Omega, V_{GE}=\pm 15\text{V}, T_j=150^\circ\text{C}$ | | | 18 | | ns |
| t_r | Rise Time | | | | 18 | | ns |
| $t_{d(off)}$ | Turn-Off Delay Time | | | 160 | | ns | |
| t_f | Fall Time | | | 40 | | ns | |
| E_{on} | Turn-On Switching Loss | | | 0.51 | | mJ | |
| E_{off} | Turn-Off Switching Loss | | | 1.36 | | mJ | |
| I_{SC} | SC Data | | $t_p \leq 6\mu\text{s}, V_{GE}=15\text{V}, T_j=150^\circ\text{C}, V_{CC}=300\text{V}, V_{CEM} \leq 600\text{V}$ | | 250 | | A |

Diode Characteristics $T_C=25^\circ\text{C}$ unless otherwise noted

| Symbol | Parameter | Test Conditions | Min. | Typ. | Max. | Unit |
|-----------|-------------------------------|--|------|------|------|---------------|
| V_F | Diode Forward Voltage | $I_F=50\text{A}, V_{GE}=0\text{V}, T_j=25^\circ\text{C}$ | | 1.55 | 2.05 | V |
| | | $I_F=50\text{A}, V_{GE}=0\text{V}, T_j=125^\circ\text{C}$ | | 1.50 | | |
| | | $I_F=50\text{A}, V_{GE}=0\text{V}, T_j=150^\circ\text{C}$ | | 1.45 | | |
| Q_r | Recovered Charge | $V_R=300\text{V}, I_F=50\text{A},$ $-di/dt=2420\text{A}/\mu\text{s}, V_{GE}=-15\text{V}$ $T_j=25^\circ\text{C}$ | | 2.2 | | μC |
| I_{RM} | Peak Reverse Recovery Current | | | 55 | | A |
| E_{rec} | Reverse Recovery Energy | | | 0.55 | | mJ |
| Q_r | Recovered Charge | $V_R=300\text{V}, I_F=50\text{A},$ $-di/dt=2420\text{A}/\mu\text{s}, V_{GE}=-15\text{V}$ $T_j=125^\circ\text{C}$ | | 4.3 | | μC |
| I_{RM} | Peak Reverse Recovery Current | | | 66 | | A |
| E_{rec} | Reverse Recovery Energy | | | 1.10 | | mJ |
| Q_r | Recovered Charge | $V_R=300\text{V}, I_F=50\text{A},$ $-di/dt=2420\text{A}/\mu\text{s}, V_{GE}=-15\text{V}$ $T_j=150^\circ\text{C}$ | | 4.8 | | μC |
| I_{RM} | Peak Reverse Recovery Current | | | 72 | | A |
| E_{rec} | Reverse Recovery Energy | | | 1.27 | | mJ |

NTC Characteristics $T_C=25^\circ\text{C}$ unless otherwise noted

| Symbol | Parameter | Test Conditions | Min. | Typ. | Max. | Unit |
|--------------|------------------------|--|------|------|------|------------|
| R_{25} | Rated Resistance | | | 5.0 | | k Ω |
| $\Delta R/R$ | Deviation of R_{100} | $T_C=100^\circ\text{C}, R_{100}=493.3\Omega$ | -5 | | 5 | % |
| P_{25} | Power Dissipation | | | | 20.0 | mW |
| $B_{25/50}$ | B-value | $R_2=R_{25}\exp[B_{25/50}(1/T_2-1/(298.15\text{K}))]$ | | 3375 | | K |
| $B_{25/80}$ | B-value | $R_2=R_{25}\exp[B_{25/80}(1/T_2-1/(298.15\text{K}))]$ | | 3411 | | K |
| $B_{25/100}$ | B-value | $R_2=R_{25}\exp[B_{25/100}(1/T_2-1/(298.15\text{K}))]$ | | 3433 | | K |

Module Characteristics $T_C=25^\circ\text{C}$ unless otherwise noted

| Symbol | Parameter | Min. | Typ. | Max. | Unit |
|---------------|--|------|-------|-------|------------|
| L_{CE} | Stray Inductance | | 25 | | nH |
| $R_{CC'+EE'}$ | Module Lead Resistance, Terminal to Chip | | 4.50 | | m Ω |
| R_{thJC} | Junction-to-Case (per IGBT-inverter) | | 0.527 | 0.580 | K/W |
| | Junction-to-Case (per Diode-inverter) | | 0.825 | 0.907 | |
| R_{thCH} | Case-to-Sink (per IGBT-inverter) | | 0.571 | | K/W |
| | Case-to-Sink (per Diode-inverter) | | 0.892 | | |
| | Case-to-Sink (per Module) | | 0.058 | | |
| F | Mounting Force Per Clamp | 20 | | 50 | N |
| G | Weight of Module | | 24 | | g |

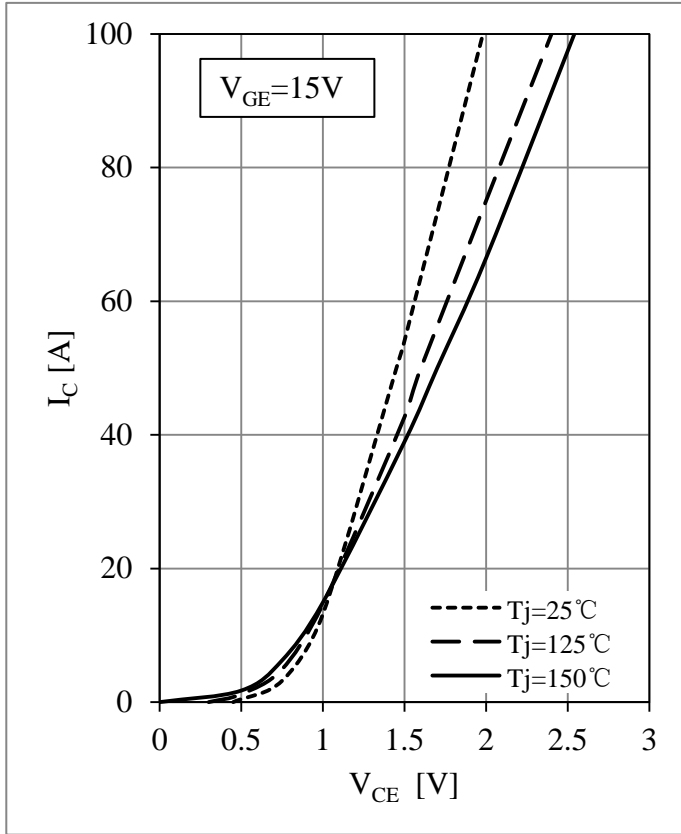

Fig 1. IGBT Output Characteristics

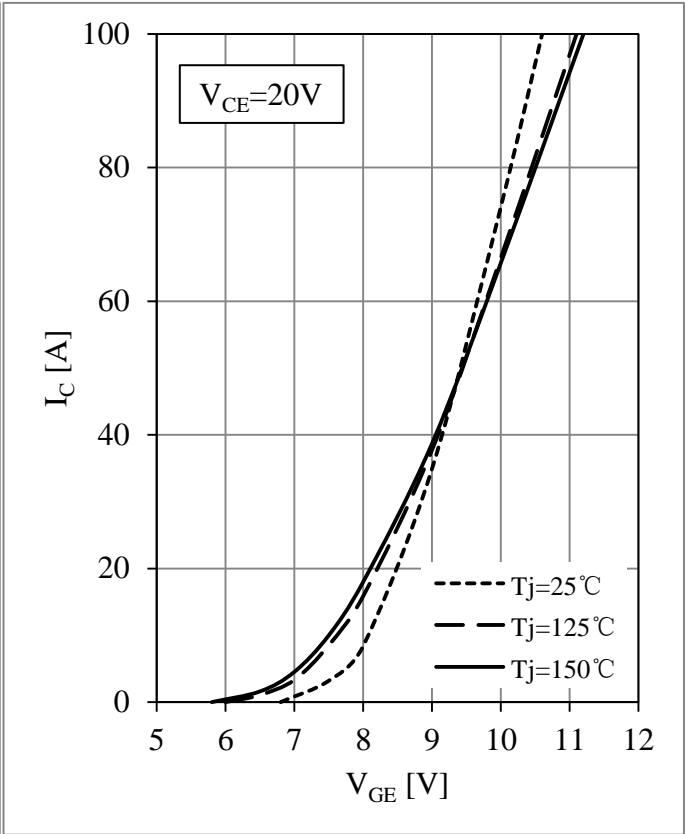

Fig 2. IGBT Transfer Characteristics

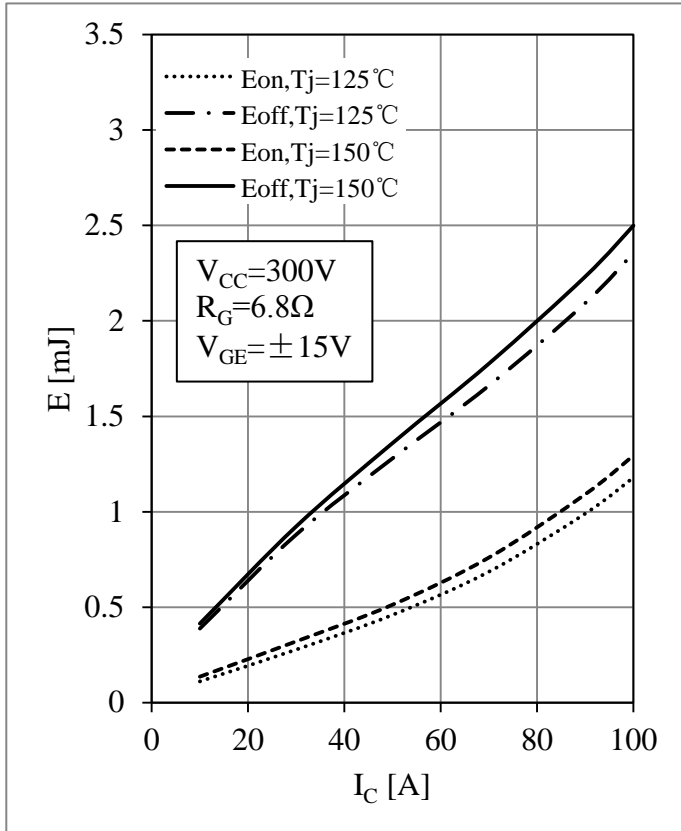

Fig 3. IGBT Switching Loss vs. I_C

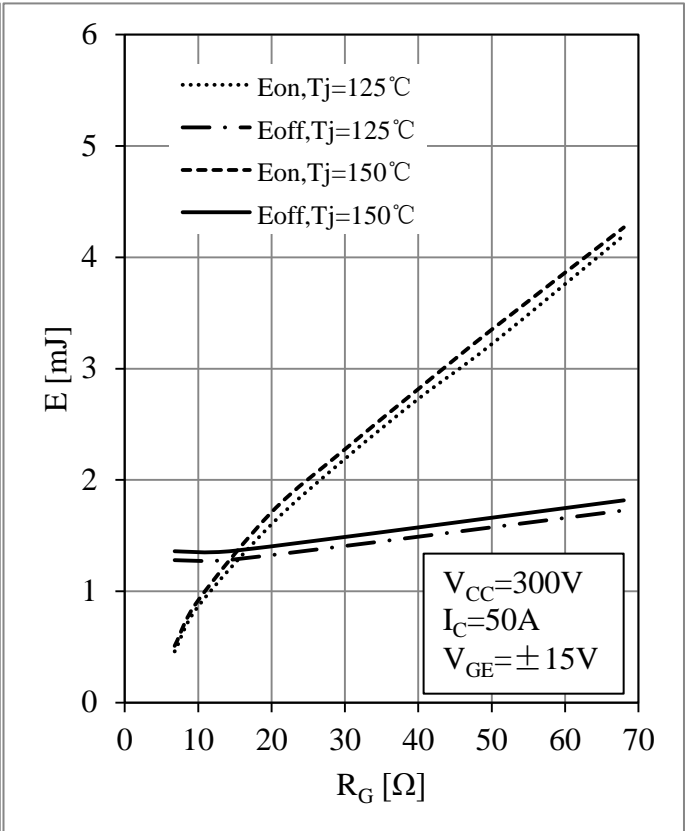

Fig 4. IGBT Switching Loss vs. R_G

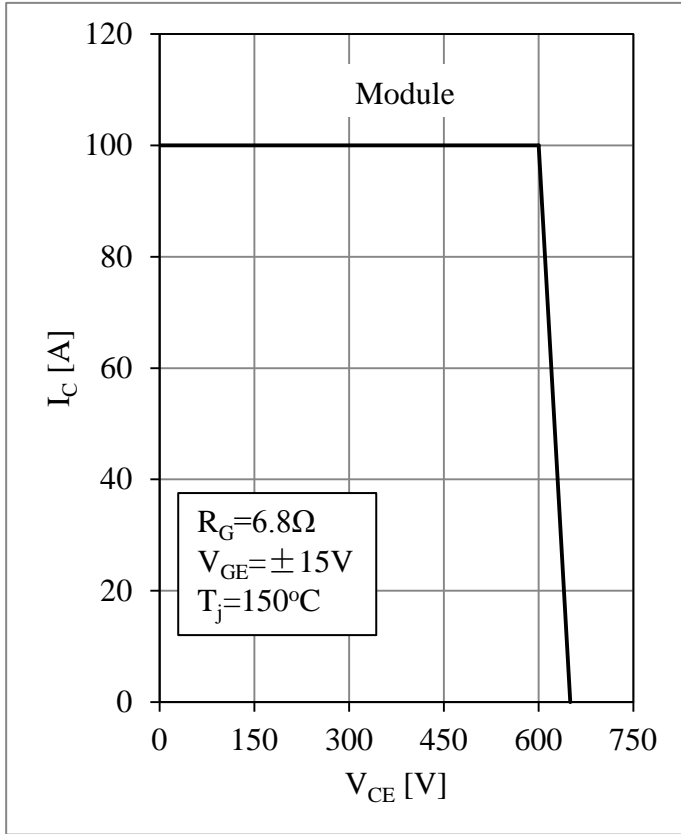

Fig 5. RBSOA

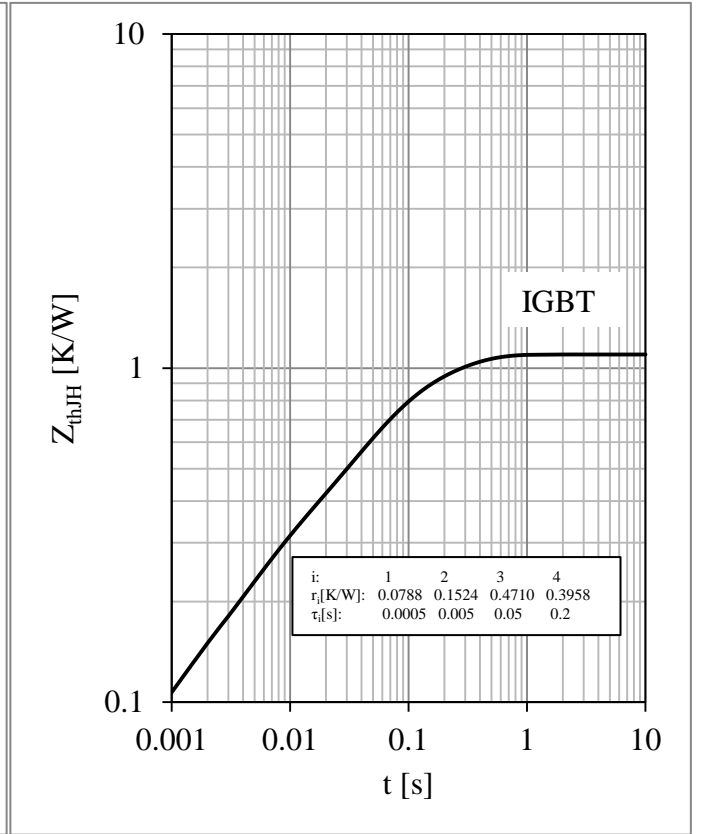

Fig 6. IGBT Transient Thermal Impedance

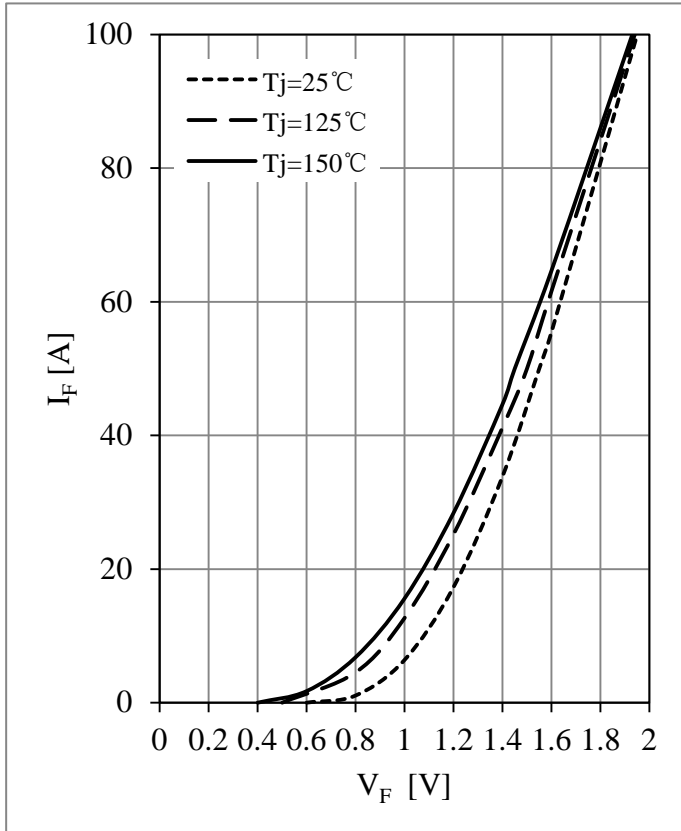

Fig 7. Diode Forward Characteristics

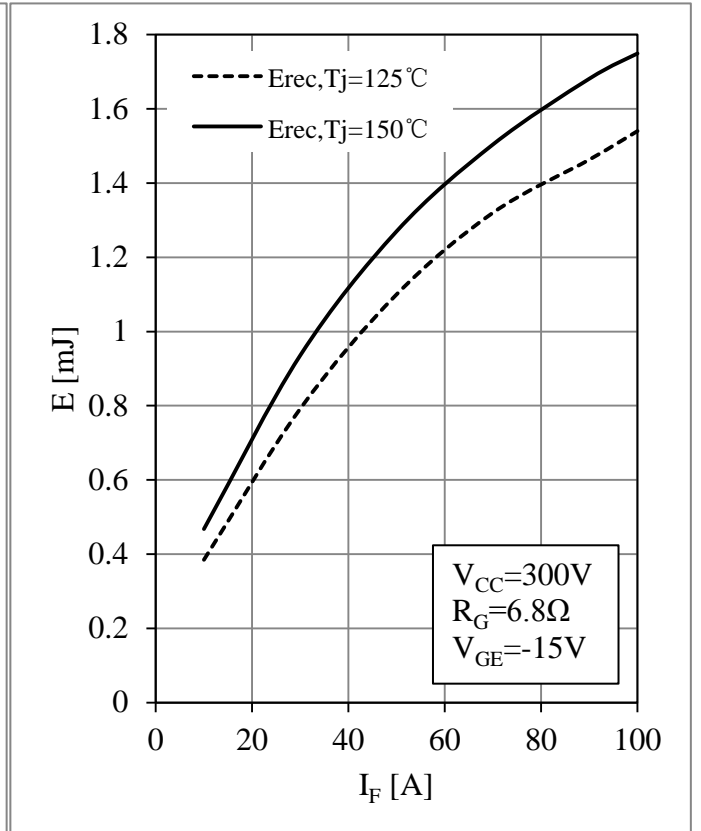

Fig 8. Diode Switching Loss vs. I_F

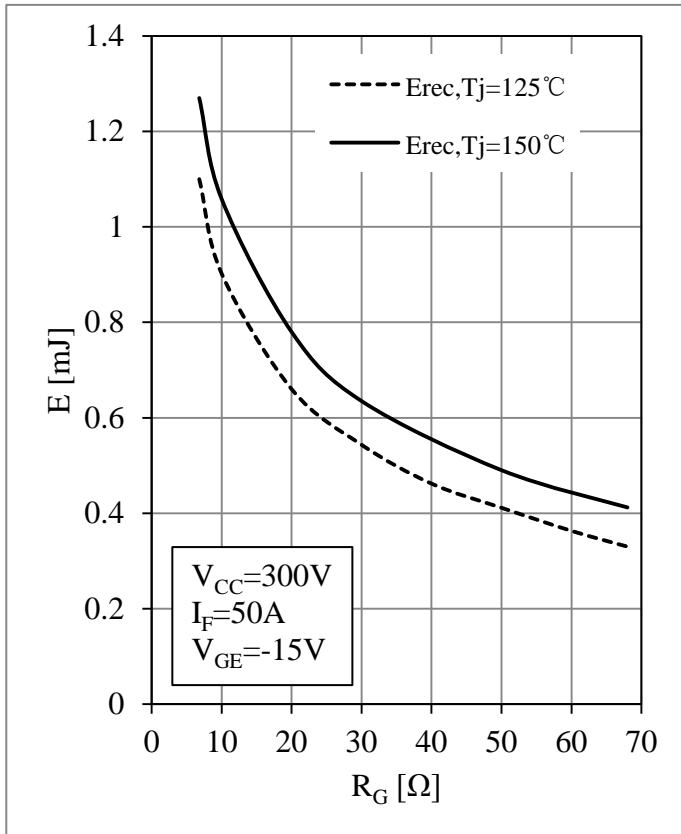

Fig 9. Diode Switching Loss vs. R_G

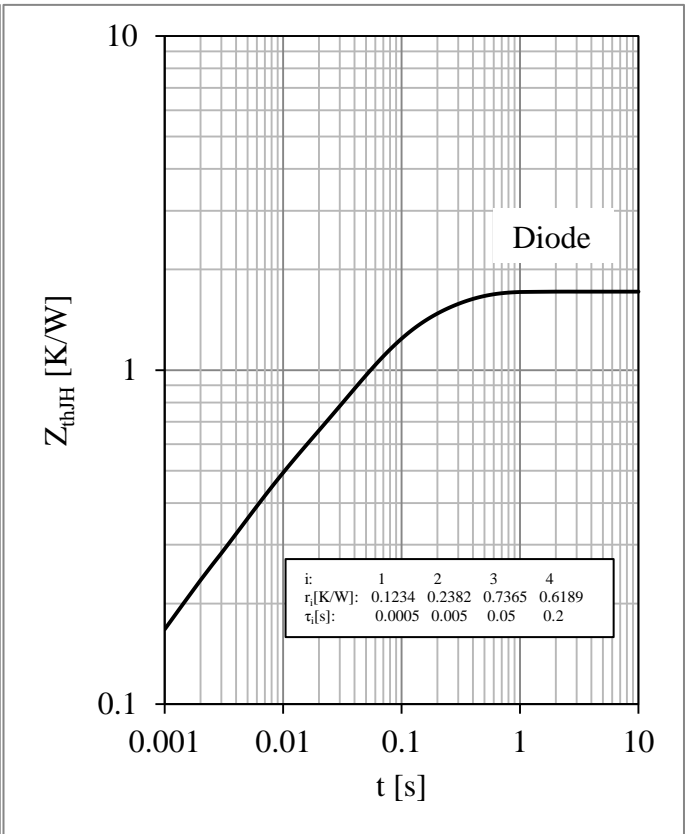

Fig 10. Diode Transient Thermal Impedance

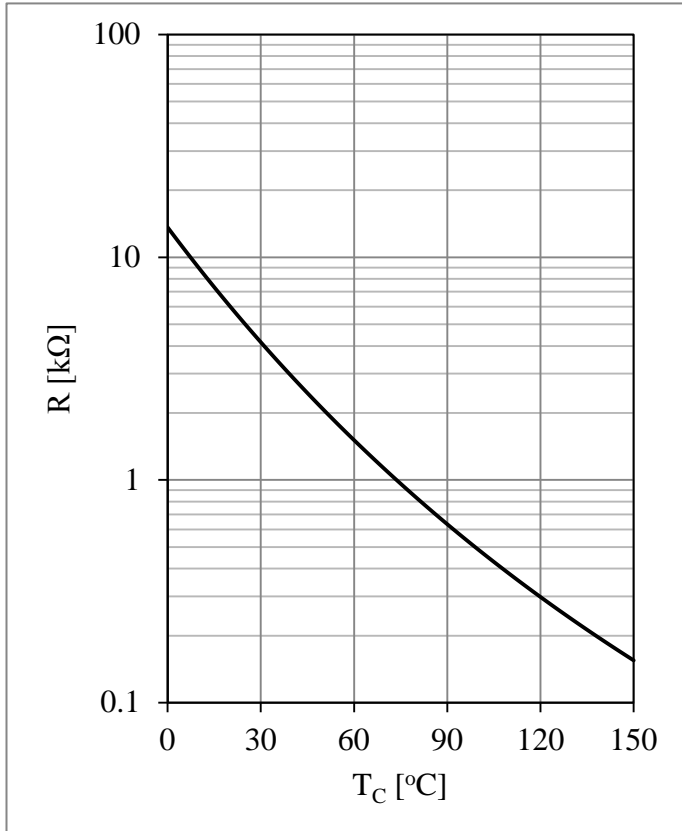
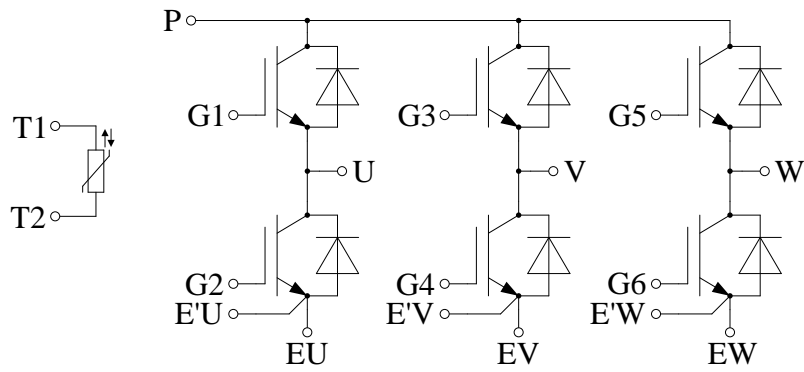

Fig 11. NTC Temperature Characteristic

Circuit Schematic



Package Dimensions

Dimensions in Millimeters

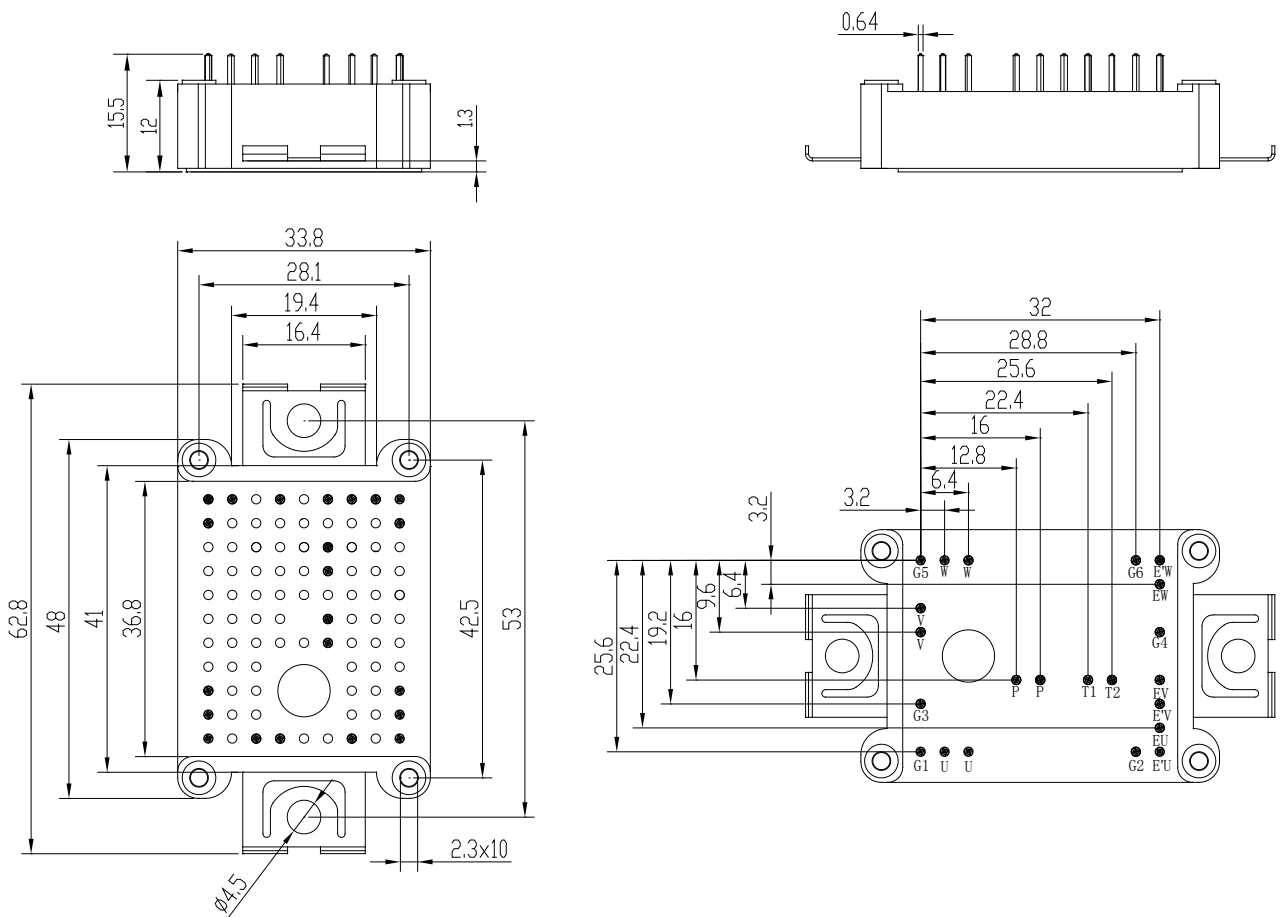

Terms and Conditions of Usage

The data contained in this product datasheet is exclusively intended for technically trained staff. you and your technical departments will have to evaluate the suitability of the product for the intended application and the completeness of the product data with respect to such application.

This product data sheet is describing the characteristics of this product for which a warranty is granted. Any such warranty is granted exclusively pursuant the terms and conditions of the supply agreement. There will be no guarantee of any kind for the product and its characteristics.

Should you require product information in excess of the data given in this product data sheet or which concerns the specific application of our product, please contact the sales office, which is responsible for you (see www.powersemi.cc), For those that are specifically interested we may provide application notes.

Due to technical requirements our product may contain dangerous substances. For information on the types in question please contact the sales office, which is responsible for you.

Should you intend to use the Product in aviation applications, in health or live endangering or life support applications, please notify.

If and to the extent necessary, please forward equivalent notices to your customers.
Changes of this product data sheet are reserved.