

STARPOWER

SEMICONDUCTOR

IGBT

GD450HFL170C2S

1700V/450A 2 in one-package

General Description

STARPOWER IGBT Power Module provides ultra low conduction loss as well as short circuit ruggedness. They are designed for the applications such as general inverters.

Features

- Low $V_{CE(sat)}$ SPT+ IGBT technology
- 10 μ s short circuit capability
- $V_{CE(sat)}$ with positive temperature coefficient
- Maximum junction temperature 175°C
- Low inductance case
- Fast & soft reverse recovery anti-parallel FWD
- Isolated copper baseplate using DBC technology



Typical Applications

- Inverter for motor drive
- Wind turbine
- High power converter

Equivalent Circuit Schematic

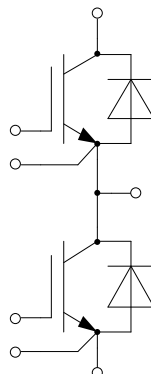

Absolute Maximum Ratings $T_C=25^{\circ}\text{C}$ unless otherwise noted**IGBT**

Symbol	Description	Value	Unit
V_{CES}	Collector-Emitter Voltage	1700	V
V_{GES}	Gate-Emitter Voltage	± 20	V
I_C	Collector Current @ $T_C=25^{\circ}\text{C}$	683	A
	@ $T_C=95^{\circ}\text{C}$	450	A
I_{CM}	Pulsed Collector Current $t_p=1\text{ms}$	900	A
P_D	Maximum Power Dissipation @ $T_j=175^{\circ}\text{C}$	2678	W

Diode

Symbol	Description	Value	Unit
V_{RRM}	Repetitive Peak Reverse Voltage	1700	V
I_F	Diode Continuous Forward Current	450	A
I_{FM}	Diode Maximum Forward Current $t_p=1\text{ms}$	900	A

Module

Symbol	Description	Value	Unit
T_{jmax}	Maximum Junction Temperature	175	$^{\circ}\text{C}$
T_{jop}	Operating Junction Temperature	-40 to +150	$^{\circ}\text{C}$
T_{STG}	Storage Temperature Range	-40 to +125	$^{\circ}\text{C}$
V_{ISO}	Isolation Voltage RMS, $f=50\text{Hz}$, $t=1\text{min}$	4000	V

IGBT Characteristics $T_C=25^\circ\text{C}$ unless otherwise noted

Symbol	Parameter	Test Conditions	Min.	Typ.	Max.	Unit	
$V_{CE(sat)}$	Collector to Emitter Saturation Voltage	$I_C=450\text{A}, V_{GE}=15\text{V}, T_j=25^\circ\text{C}$		2.00	2.45	V	
		$I_C=450\text{A}, V_{GE}=15\text{V}, T_j=125^\circ\text{C}$		2.40			
		$I_C=450\text{A}, V_{GE}=15\text{V}, T_j=150^\circ\text{C}$		2.50			
$V_{GE(th)}$	Gate-Emitter Threshold Voltage	$I_C=18.0\text{mA}, V_{CE}=V_{GE}, T_j=25^\circ\text{C}$	5.4	6.1	7.4	V	
I_{CES}	Collector Cut-Off Current	$V_{CE}=V_{CES}, V_{GE}=0\text{V}, T_j=25^\circ\text{C}$			5.0	mA	
I_{GES}	Gate-Emitter Leakage Current	$V_{GE}=V_{GES}, V_{CE}=0\text{V}, T_j=25^\circ\text{C}$			400	nA	
R_{Gint}	Internal Gate Resistance			0.3		Ω	
C_{ies}	Input Capacitance	$V_{CE}=25\text{V}, f=1\text{MHz}, V_{GE}=0\text{V}$		30.0		nF	
C_{res}	Reverse Transfer Capacitance			1.08		nF	
Q_G	Gate Charge	$V_{GE}=-15\dots+15\text{V}$		2.70		μC	
$t_{d(on)}$	Turn-On Delay Time	$V_{CC}=900\text{V}, I_C=450\text{A}, R_G=3.3\Omega, V_{GE}=\pm 15\text{V}, T_j=25^\circ\text{C}$		504		ns	
t_r	Rise Time			183		ns	
$t_{d(off)}$	Turn-Off Delay Time			616		ns	
t_f	Fall Time			188		ns	
E_{on}	Turn-On Switching Loss			126		mJ	
E_{off}	Turn-Off Switching Loss			89		mJ	
$t_{d(on)}$	Turn-On Delay Time		$V_{CC}=900\text{V}, I_C=450\text{A}, R_G=3.3\Omega, V_{GE}=\pm 15\text{V}, T_j=125^\circ\text{C}$		506		ns
t_r	Rise Time				194		ns
$t_{d(off)}$	Turn-Off Delay Time			704		ns	
t_f	Fall Time			352		ns	
E_{on}	Turn-On Switching Loss			162		mJ	
E_{off}	Turn-Off Switching Loss			124		mJ	
$t_{d(on)}$	Turn-On Delay Time	$V_{CC}=900\text{V}, I_C=450\text{A}, R_G=3.3\Omega, V_{GE}=\pm 15\text{V}, T_j=150^\circ\text{C}$			510		ns
t_r	Rise Time				198		ns
$t_{d(off)}$	Turn-Off Delay Time			727		ns	
t_f	Fall Time			429		ns	
E_{on}	Turn-On Switching Loss			174		mJ	
E_{off}	Turn-Off Switching Loss			132		mJ	
I_{SC}	SC Data		$t_p \leq 10\mu\text{s}, V_{GE}=15\text{V}, T_j=150^\circ\text{C}, V_{CC}=1000\text{V}, V_{CEM} \leq 1700\text{V}$		1440		A

Diode Characteristics $T_C=25^{\circ}\text{C}$ unless otherwise noted

Symbol	Parameter	Test Conditions	Min.	Typ.	Max.	Unit
V_F	Diode Forward Voltage	$I_F=450\text{A}, V_{GE}=0\text{V}, T_j=25^{\circ}\text{C}$		1.87	2.32	V
		$I_F=450\text{A}, V_{GE}=0\text{V}, T_j=125^{\circ}\text{C}$		2.00		
		$I_F=450\text{A}, V_{GE}=0\text{V}, T_j=150^{\circ}\text{C}$		2.05		
Q_r	Recovered Charge			107		μC
I_{RM}	Peak Reverse Recovery Current	$V_R=900\text{V}, I_F=450\text{A},$ $-di/dt=3000\text{A}/\mu\text{s}, V_{GE}=-15\text{V}$ $T_j=25^{\circ}\text{C}$		519		A
E_{rec}	Reverse Recovery Energy			75		mJ
Q_r	Recovered Charge			159		μC
I_{RM}	Peak Reverse Recovery Current	$V_R=900\text{V}, I_F=450\text{A},$ $-di/dt=3000\text{A}/\mu\text{s}, V_{GE}=-15\text{V}$ $T_j=125^{\circ}\text{C}$		597		A
E_{rec}	Reverse Recovery Energy			113		mJ
Q_r	Recovered Charge			170		μC
I_{RM}	Peak Reverse Recovery Current	$V_R=900\text{V}, I_F=450\text{A},$ $-di/dt=3000\text{A}/\mu\text{s}, V_{GE}=-15\text{V}$ $T_j=150^{\circ}\text{C}$		611		A
E_{rec}	Reverse Recovery Energy			119		mJ

Module Characteristics $T_C=25^{\circ}\text{C}$ unless otherwise noted

Symbol	Parameter	Min.	Typ.	Max.	Unit
L_{CE}	Stray Inductance			20	nH
$R_{CC'+EE'}$	Module Lead Resistance, Terminal to Chip		0.35		m Ω
R_{thJC}	Junction-to-Case (per IGBT)			0.056	K/W
	Junction-to-Case (per Diode)			0.112	
R_{thCH}	Case-to-Heatsink (per IGBT)		0.105		K/W
	Case-to-Heatsink (per Diode)		0.210		
	Case-to-Heatsink (per Module)		0.035		
M	Terminal Connection Torque, Screw M6	2.5		5.0	N.m
	Mounting Torque, Screw M6	3.0		5.0	
G	Weight of Module		300		g

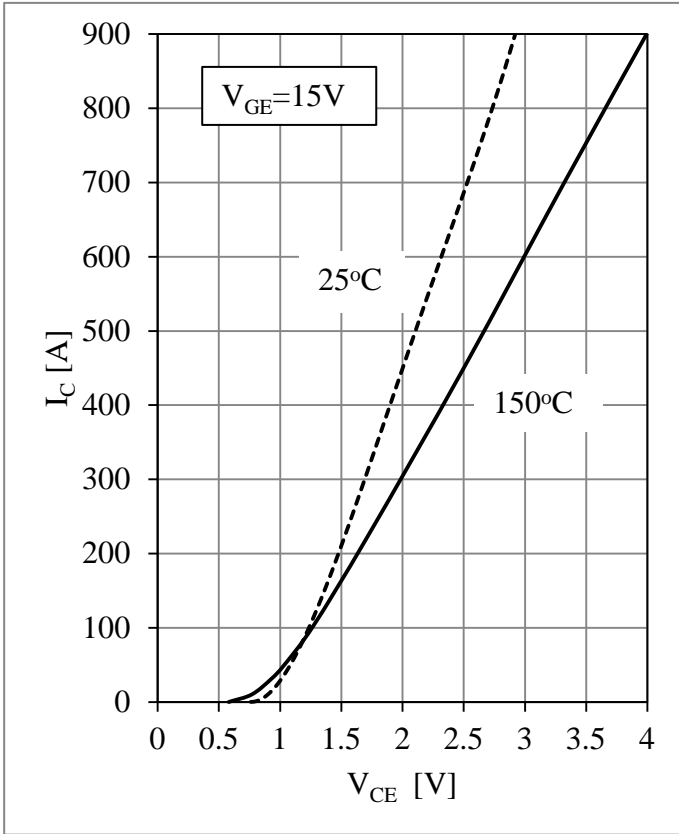

Fig 1. IGBT Output Characteristics

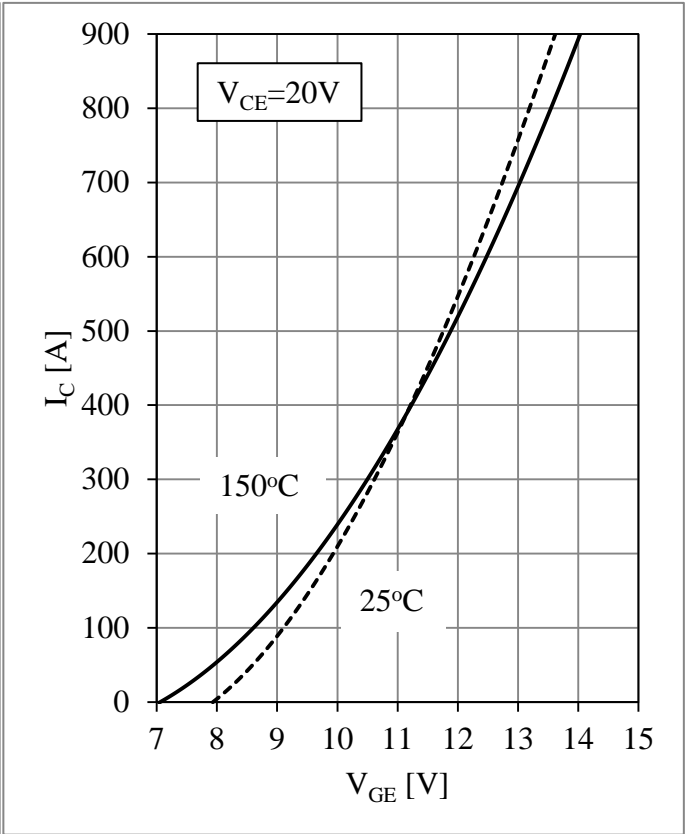

Fig 2. IGBT Transfer Characteristics

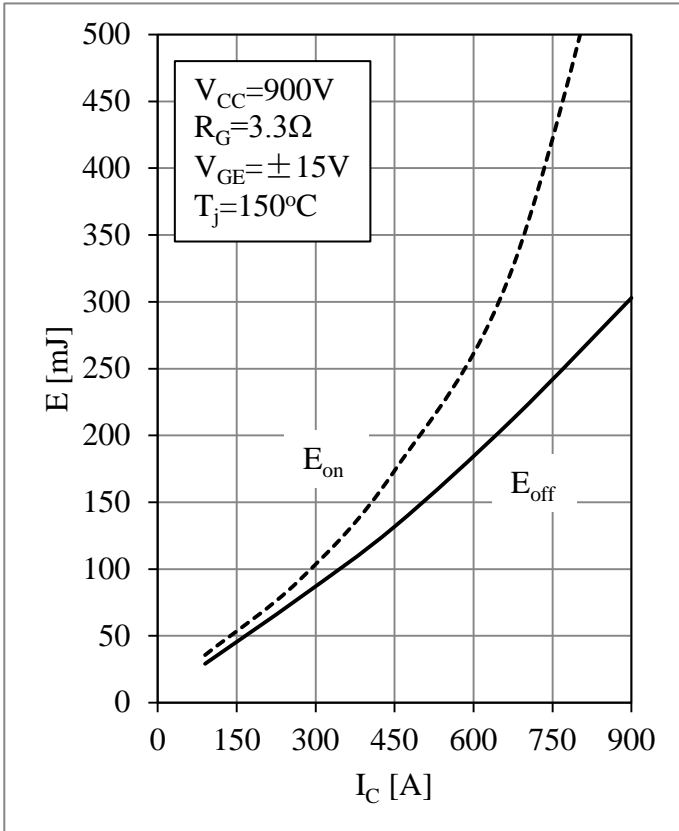

Fig 3. IGBT Switching Loss vs. I_C

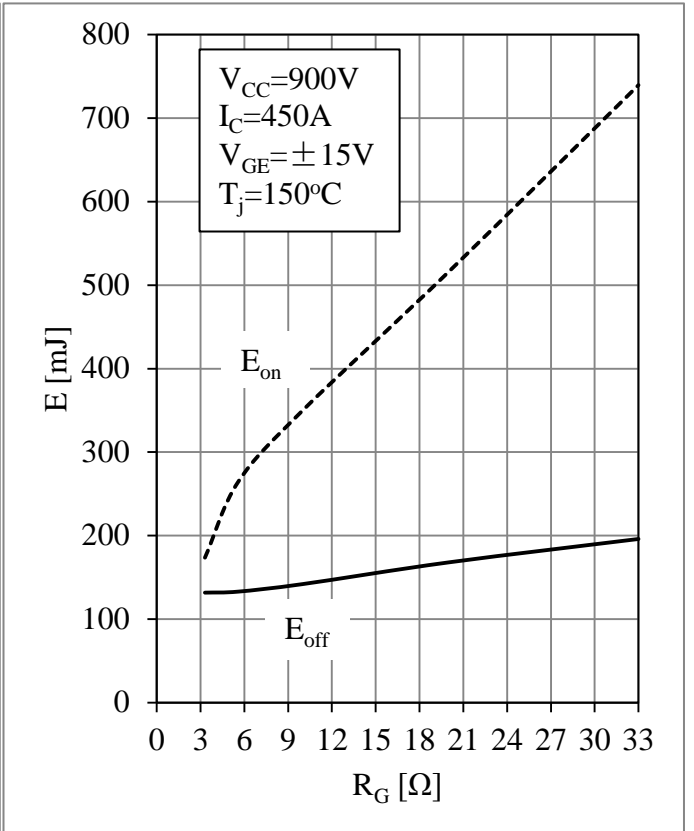

Fig 4. IGBT Switching Loss vs. R_G

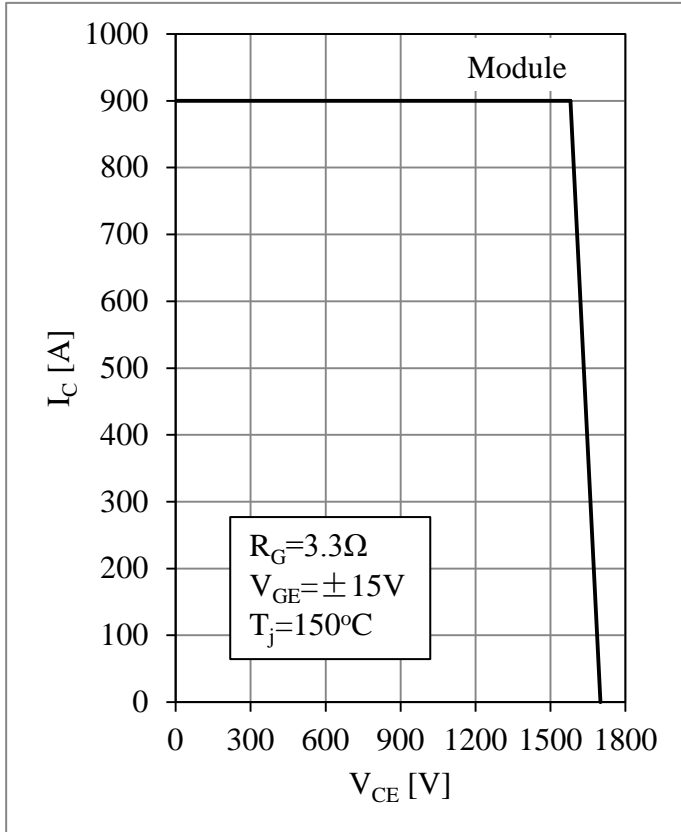

Fig 5. RBSOA

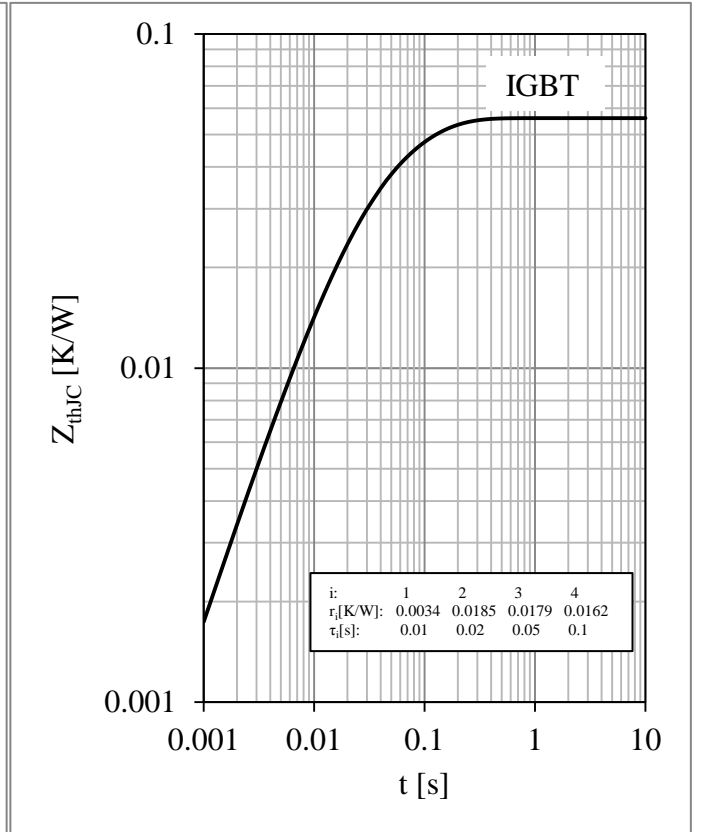

Fig 6. IGBT Transient Thermal Impedance

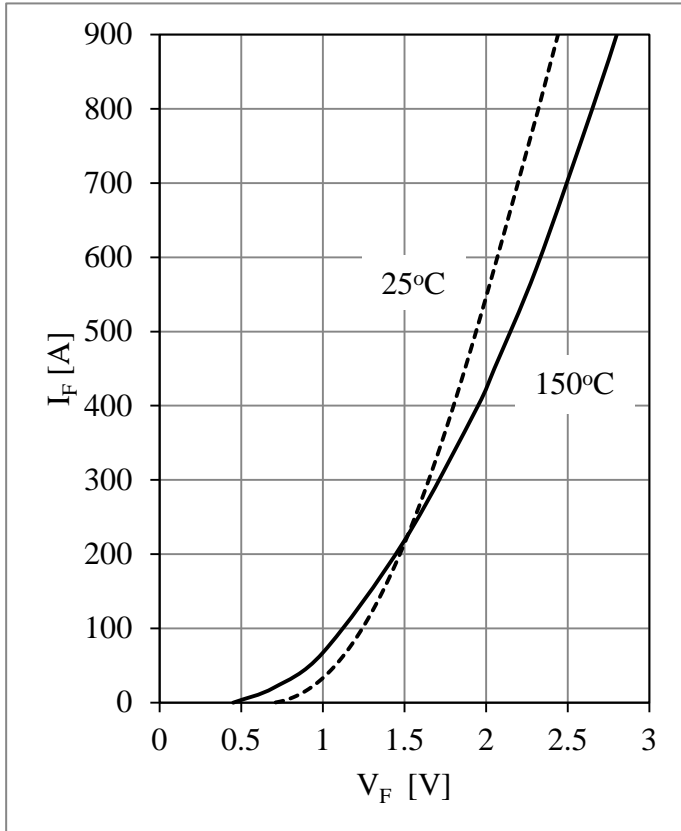

Fig 7. Diode Forward Characteristics

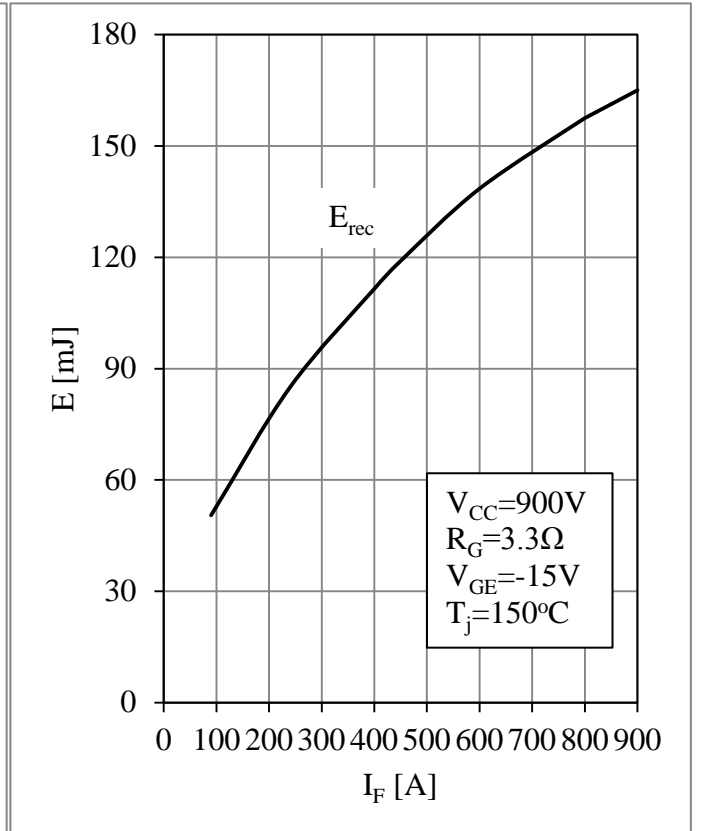

Fig 8. Diode Switching Loss vs. I_F

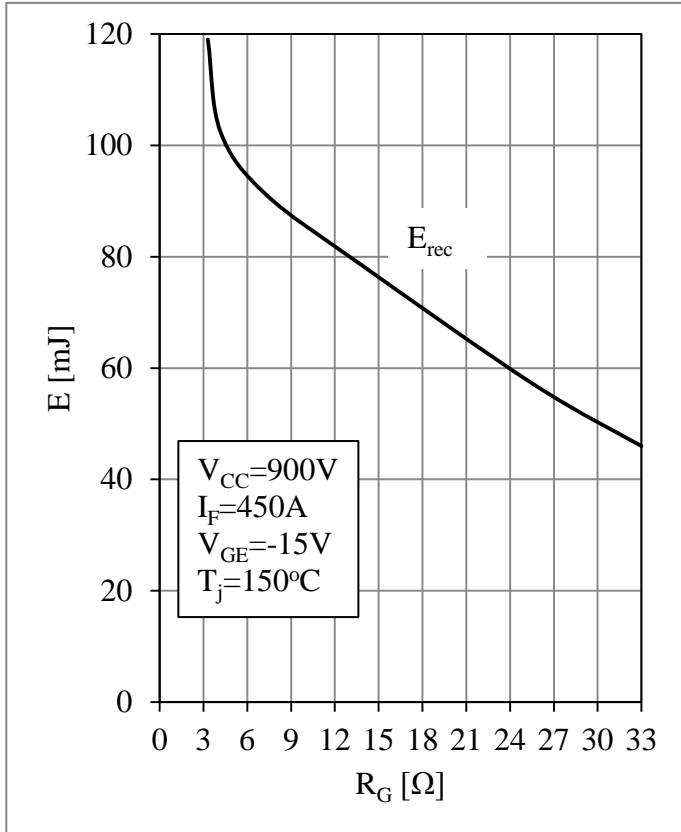

Fig 9. Diode Switching Loss vs. R_G

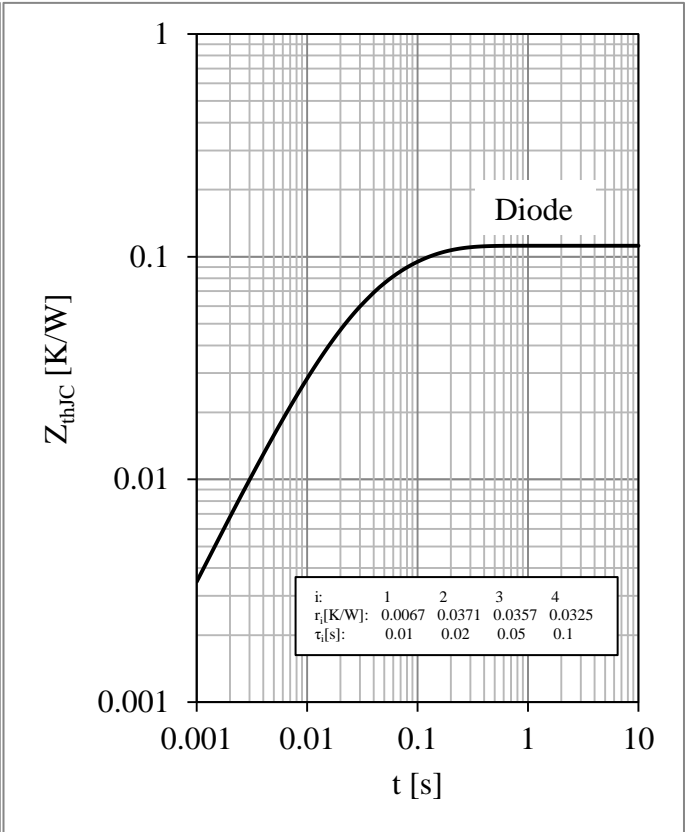
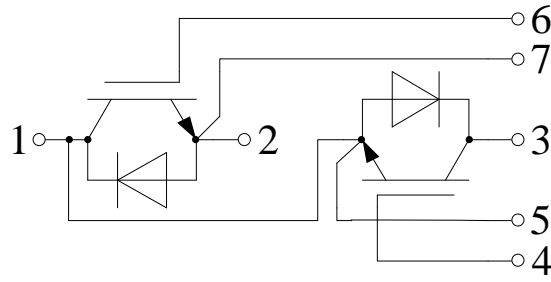

Fig 10. Diode Transient Thermal Impedance

Circuit Schematic



Package Dimensions

Dimensions in Millimeters

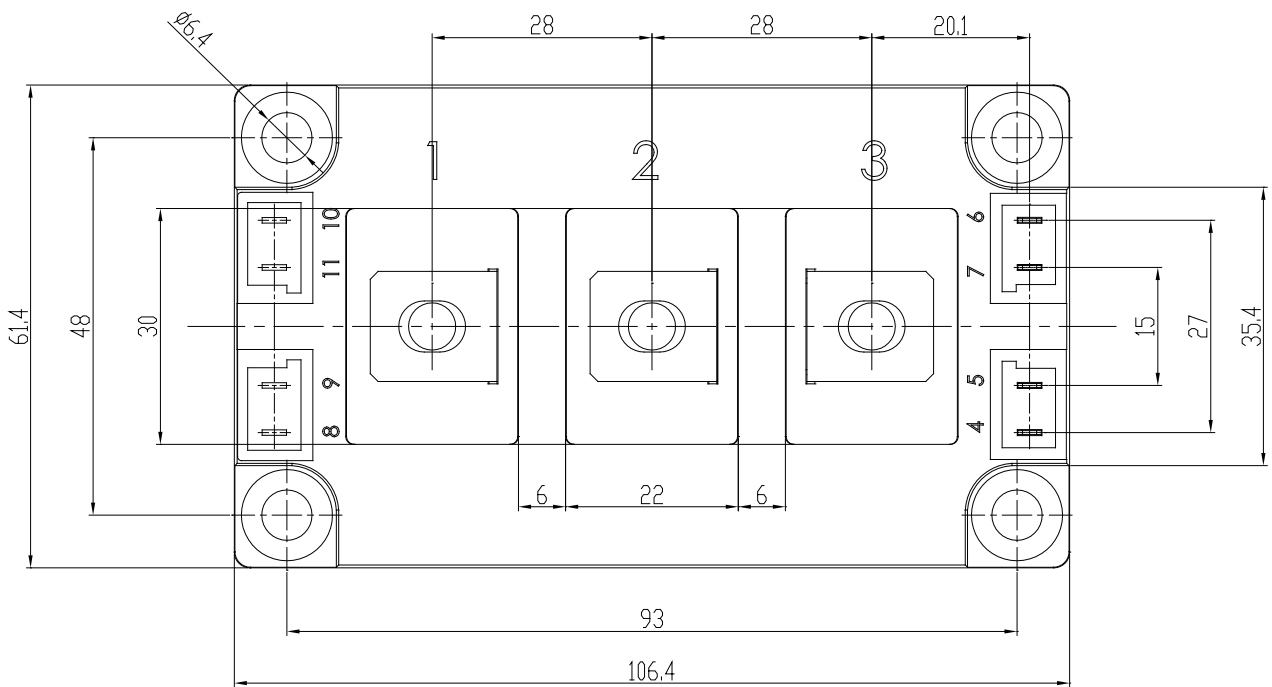
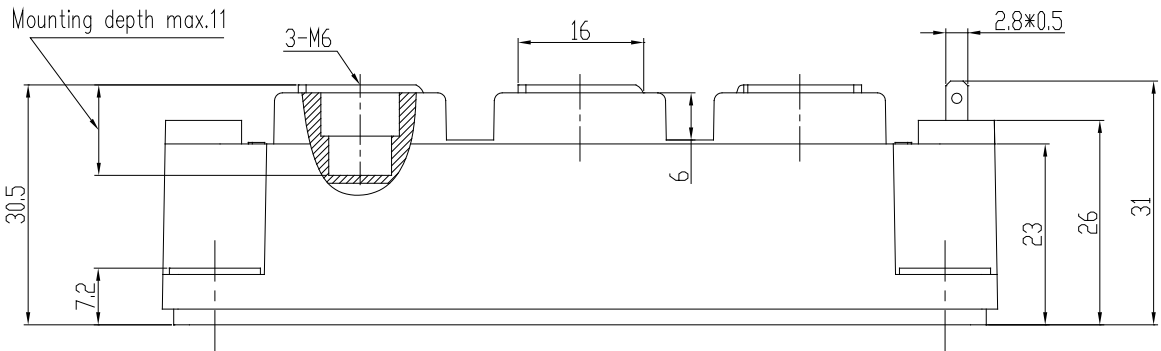

Terms and Conditions of Usage

The data contained in this product datasheet is exclusively intended for technically trained staff. you and your technical departments will have to evaluate the suitability of the product for the intended application and the completeness of the product data with respect to such application.

This product data sheet is describing the characteristics of this product for which a warranty is granted. Any such warranty is granted exclusively pursuant the terms and conditions of the supply agreement. There will be no guarantee of any kind for the product and its characteristics.

Should you require product information in excess of the data given in this product data sheet or which concerns the specific application of our product, please contact the sales office, which is responsible for you (see www.powersemi.cc), For those that are specifically interested we may provide application notes.

Due to technical requirements our product may contain dangerous substances. For information on the types in question please contact the sales office, which is responsible for you.

Should you intend to use the Product in aviation applications, in health or live endangering or life support applications, please notify.

If and to the extent necessary, please forward equivalent notices to your customers.
Changes of this product data sheet are reserved.