

STARPOWER

SEMICONDUCTOR

IGBT

GD25PIT120C5S

Molding Type Module**1200V/25A PIM in one-package**

General Description

STARPOWER IGBT Power Module provides ultra low conduction loss as well as short circuit ruggedness. They are designed for the applications such as general inverters and UPS.



Features

- Low $V_{CE(sat)}$ trench IGBT technology
- 10 μ s short circuit capability
- $V_{CE(sat)}$ with positive temperature coefficient
- Maximum junction temperature 175 °C
- Low inductance case
- Fast & soft reverse recovery anti-parallel FWD
- Isolated copper baseplate using DBC technology

Typical Applications

- Inverter for motor drive
- AC and DC servo drive amplifier
- Uninterruptible power supply

IGBT-inverter $T_C=25^\circ\text{C}$ unless otherwise noted**Maximum Rated Values**

Symbol	Description	GD25PIT120C5S	Units
V_{CES}	Collector-Emitter Voltage @ $T_j=25^\circ\text{C}$	1200	V
V_{GES}	Gate-Emitter Voltage @ $T_j=25^\circ\text{C}$	± 30	V
I_C	Collector Current @ $T_C=25^\circ\text{C}$ @ $T_C=100^\circ\text{C}$	50 25	A
I_{CM}	Pulsed Collector Current $t_p=1\text{ms}$	50	A
P_{tot}	Total Power Dissipation @ $T_j=175^\circ\text{C}$	212	W

Off Characteristics

Symbol	Parameter	Test Conditions	Min.	Typ.	Max.	Units
$V_{(BR)CES}$	Collector-Emitter Breakdown Voltage	$T_j=25^\circ\text{C}$	1200			V
I_{CES}	Collector Cut-Off Current	$V_{CE}=V_{CES}, V_{GE}=0\text{V},$ $T_j=25^\circ\text{C}$			5.0	mA
I_{GES}	Gate-Emitter Leakage Current	$V_{GE}=V_{GES}, V_{CE}=0\text{V},$ $T_j=25^\circ\text{C}$			400	nA

On Characteristics

Symbol	Parameter	Test Conditions	Min.	Typ.	Max.	Units
$V_{GE(th)}$	Gate-Emitter Threshold Voltage	$I_C=1.2\text{mA}, V_{CE}=V_{GE},$ $T_j=25^\circ\text{C}$	5.0	6.3	7.5	V
$V_{CE(sat)}$	Collector to Emitter Saturation Voltage	$I_C=25\text{A}, V_{GE}=15\text{V},$ $T_j=25^\circ\text{C}$		1.90	2.35	V
		$I_C=25\text{A}, V_{GE}=15\text{V},$ $T_j=125^\circ\text{C}$		2.30		
		$I_C=25\text{A}, V_{GE}=15\text{V},$ $T_j=150^\circ\text{C}$		2.40		

Switching Characteristics

Symbol	Parameter	Test Conditions	Min.	Typ.	Max.	Units
$t_{d(on)}$	Turn-On Delay Time	$V_{CC}=600V, I_C=25A,$ $R_G=33\Omega, V_{GE}=\pm 15V,$ $T_j=25^\circ C$		233		ns
t_r	Rise Time			66		ns
$t_{d(off)}$	Turn-Off Delay Time			184		ns
t_f	Fall Time			208		ns
E_{on}	Turn-On Switching Loss			3.06		mJ
E_{off}	Turn-Off Switching Loss			1.16		mJ
$t_{d(on)}$	Turn-On Delay Time	$V_{CC}=600V, I_C=25A,$ $R_G=33\Omega, V_{GE}=\pm 15V,$ $T_j=125^\circ C$		310		ns
t_r	Rise Time			86		ns
$t_{d(off)}$	Turn-Off Delay Time			217		ns
t_f	Fall Time			324		ns
E_{on}	Turn-On Switching Loss			3.50		mJ
E_{off}	Turn-Off Switching Loss			1.78		mJ
$t_{d(on)}$	Turn-On Delay Time	$V_{CC}=600V, I_C=25A,$ $R_G=33\Omega, V_{GE}=\pm 15V,$ $T_j=150^\circ C$		221		ns
t_r	Rise Time			68		ns
$t_{d(off)}$	Turn-Off Delay Time			225		ns
t_f	Fall Time			347		ns
E_{on}	Turn-On Switching Loss			4.45		mJ
E_{off}	Turn-Off Switching Loss			2.02		mJ
C_{ies}	Input Capacitance	$V_{CE}=30V, f=1Mhz,$ $V_{GE}=0V$		3.43		nF
C_{oes}	Output Capacitance			0.13		nF
C_{res}	Reverse Transfer Capacitance			0.08		nF
Q_G	Gate Charge	$V_{CC}=600V, I_C=25A,$ $V_{GE}=15V$		160		nC
I_{sc}	SC Data	$t_p \leq 10\mu s, V_{GE}=15V,$ $T_j=125^\circ C, V_{CC}=900V,$ $V_{CEM} \leq 1200V$		225		A

Diode-inverter $T_C=25^\circ\text{C}$ unless otherwise noted**Maximum Rated Values**

Symbol	Description	GD25PIT120C5S	Units
V_{RRM}	Repetitive Peak Reverse Voltage @ $T_j=25^\circ\text{C}$	1200	V
I_F	DC Forward Current	25	A
I_{FRM}	Repetitive Peak Forward Current $t_p=1\text{ms}$	50	A

Characteristics Values

Symbol	Parameter	Test Conditions	Min.	Typ.	Max.	Units
V_F	Diode Forward Voltage	$I_F=25\text{A}, V_{GE}=0\text{V}$	$T_j=25^\circ\text{C}$	1.78	2.18	V
			$T_j=125^\circ\text{C}$	1.88		
			$T_j=150^\circ\text{C}$	1.91		
Q_r	Recovered Charge	$I_F=25\text{A}, V_R=600\text{V}, R_G=33\Omega, V_{GE}=-15\text{V}$	$T_j=25^\circ\text{C}$	1.1		μC
			$T_j=125^\circ\text{C}$	3.2		
			$T_j=150^\circ\text{C}$	4.5		
I_{RM}	Peak Reverse Recovery Current	$I_F=25\text{A}, V_R=600\text{V}, R_G=33\Omega, V_{GE}=-15\text{V}$	$T_j=25^\circ\text{C}$	17		A
			$T_j=125^\circ\text{C}$	21		
			$T_j=150^\circ\text{C}$	28		
E_{rec}	Reverse Recovery Energy	$I_F=25\text{A}, V_R=600\text{V}, R_G=33\Omega, V_{GE}=-15\text{V}$	$T_j=25^\circ\text{C}$	0.80		mJ
			$T_j=125^\circ\text{C}$	1.38		
			$T_j=150^\circ\text{C}$	1.96		

Diode-rectifier $T_C=25^\circ\text{C}$ unless otherwise noted**Maximum Rated Values**

Symbol	Description	GD25PIT120C5S	Units
V_{RRM}	Repetitive Peak Reverse Voltage @ $T_j=25^\circ\text{C}$	1600	V
$I_{F(AV)}$	Average On-state Current @ $T_C=100^\circ\text{C}$	31	A
I_{RMSM}	Maximum RMS Current At Rectifier Output @ $T_C=80^\circ\text{C}$	60	A
I_{FSM}	Surge Forward Current $V_R=0\text{V}, t_p=10\text{ms}, T_j=45^\circ\text{C}$	320	A
I^2t	I^2t -value, $V_R=0\text{V}, t_p=10\text{ms}, T_j=45^\circ\text{C}$	510	A^2s

Characteristics Values

Symbol	Parameter	Test Conditions	Min.	Typ.	Max.	Units
V_F	Diode Forward Voltage	$I_F=25\text{A}$ $T_j=150^\circ\text{C}$		1.05		V
I_R	Reverse Current	$T_j=150^\circ\text{C}, V_R=1600\text{V}$			2.0	mA

IGBT-brake-chopper $T_C=25^\circ\text{C}$ unless otherwise noted**Maximum Rated Values**

Symbol	Description	GD25PIT120C5S	Units
V_{CES}	Collector-Emitter Voltage @ $T_j=25^\circ\text{C}$	1200	V
V_{GES}	Gate-Emitter Voltage @ $T_j=25^\circ\text{C}$	± 20	V
I_C	Collector Current @ $T_C=25^\circ\text{C}$	30	A
	@ $T_C=100^\circ\text{C}$	15	
I_{CM}	Pulsed Collector Current $t_p=1\text{ms}$	30	A
P_{tot}	Total Power Dissipation @ $T_j=175^\circ\text{C}$	152	W

Off Characteristics

Symbol	Parameter	Test Conditions	Min.	Typ.	Max.	Units
$V_{(BR)CES}$	Collector-Emitter Breakdown Voltage	$T_j=25^\circ\text{C}$	1200			V
I_{CES}	Collector Cut-Off Current	$V_{CE}=V_{CES}, V_{GE}=0\text{V}, T_j=25^\circ\text{C}$			5.0	mA
I_{GES}	Gate-Emitter Leakage Current	$V_{GE}=V_{GES}, V_{CE}=0\text{V}, T_j=25^\circ\text{C}$			400	nA

On Characteristics

Symbol	Parameter	Test Conditions	Min.	Typ.	Max.	Units
$V_{GE(th)}$	Gate-Emitter Threshold Voltage	$I_C=600\mu\text{A}, V_{CE}=V_{GE}, T_j=25^\circ\text{C}$	5.0	5.8	6.5	V
$V_{CE(sat)}$	Collector to Emitter Saturation Voltage	$I_C=15\text{A}, V_{GE}=15\text{V}, T_j=25^\circ\text{C}$		1.70	2.15	V
		$I_C=15\text{A}, V_{GE}=15\text{V}, T_j=125^\circ\text{C}$		2.00		
		$I_C=15\text{A}, V_{GE}=15\text{V}, T_j=150^\circ\text{C}$		2.10		

Switching Characteristics

Symbol	Parameter	Test Conditions	Min.	Typ.	Max.	Units
$t_{d(on)}$	Turn-On Delay Time	$V_{CC}=600V, I_C=15A,$ $R_G=75\Omega, V_{GE}=\pm 15V,$ $T_j=25^\circ C$		84		ns
t_r	Rise Time			31		ns
$t_{d(off)}$	Turn-Off Delay Time			420		ns
t_f	Fall Time			65		ns
E_{on}	Turn-On Switching Loss			1.51		mJ
E_{off}	Turn-Off Switching Loss			1.27		mJ
$t_{d(on)}$	Turn-On Delay Time	$V_{CC}=600V, I_C=15A,$ $R_G=75\Omega, V_{GE}=\pm 15V,$ $T_j=125^\circ C$		91		ns
t_r	Rise Time			45		ns
$t_{d(off)}$	Turn-Off Delay Time			522		ns
t_f	Fall Time			90		ns
E_{on}	Turn-On Switching Loss			2.12		mJ
E_{off}	Turn-Off Switching Loss			1.48		mJ
$t_{d(on)}$	Turn-On Delay Time	$V_{CC}=600V, I_C=15A,$ $R_G=75\Omega, V_{GE}=\pm 15V,$ $T_j=150^\circ C$		91		ns
t_r	Rise Time			46		ns
$t_{d(off)}$	Turn-Off Delay Time			550		ns
t_f	Fall Time			110		ns
E_{on}	Turn-On Switching Loss			2.43		mJ
E_{off}	Turn-Off Switching Loss			1.64		mJ
C_{ies}	Input Capacitance	$V_{CE}=25V, f=1Mhz,$ $V_{GE}=0V$		1.10		nF
C_{oes}	Output Capacitance			0.06		nF
C_{res}	Reverse Transfer Capacitance			0.05		nF
Q_G	Gate Charge	$V_{CC}=600V, I_C=15A,$ $V_{GE}=-15 \dots +15V$		150		nC
I_{SC}	SC Data	$t_p \leq 10\mu s, V_{GE}=15V,$ $T_j=150^\circ C, V_{CC}=900V,$ $V_{CEM} \leq 1200V$		60		A

Diode-brake-chopper $T_C=25^\circ\text{C}$ unless otherwise noted**Maximum Rated Values**

Symbol	Description	GD25PIT120C5S	Units
V_{RRM}	Repetitive Peak Reverse Voltage @ $T_j=25^\circ\text{C}$	1200	V
I_F	DC Forward Current	15	A
I_{FRM}	Repetitive Peak Forward Current $t_p=1\text{ms}$	30	A

Characteristics Values

Symbol	Parameter	Test Conditions	Min.	Typ.	Max.	Units
V_F	Diode Forward Voltage	$I_F=15\text{A}, V_{GE}=0\text{V}$	$T_j=25^\circ\text{C}$	2.05	2.50	V
			$T_j=125^\circ\text{C}$	2.20		
			$T_j=150^\circ\text{C}$	2.24		
Q_r	Recovered Charge	$I_F=15\text{A}, V_R=600\text{V}, R_G=68\Omega, V_{GE}=-15\text{V}$	$T_j=25^\circ\text{C}$	0.6		μC
			$T_j=125^\circ\text{C}$	2.1		
			$T_j=150^\circ\text{C}$	3.0		
I_{RM}	Peak Reverse Recovery Current	$I_F=15\text{A}, V_R=600\text{V}, R_G=68\Omega, V_{GE}=-15\text{V}$	$T_j=25^\circ\text{C}$	10		A
			$T_j=125^\circ\text{C}$	12		
			$T_j=150^\circ\text{C}$	16		
E_{rec}	Reverse Recovery Energy	$I_F=15\text{A}, V_R=600\text{V}, R_G=68\Omega, V_{GE}=-15\text{V}$	$T_j=25^\circ\text{C}$	0.47		mJ
			$T_j=125^\circ\text{C}$	0.86		
			$T_j=150^\circ\text{C}$	1.22		

Electrical Characteristics of NTC $T_C=25^\circ\text{C}$ unless otherwise noted

Symbol	Parameter	Test Conditions	Min.	Typ.	Max.	Units
R_{25}	Rated Resistance			5.0		$\text{k}\Omega$
$\Delta R/R$	Deviation of R_{100}	$T_C=100^\circ\text{C}, R_{100}=493.3\Omega$	-5		5	%
P_{25}	Power Dissipation				20.0	mW
$B_{25/50}$	B-value	$R_2=R_{25}\exp[B_{25/50}(1/T_2-1/(298.15\text{K}))]$		3375		K

IGBT Module

Symbol	Parameter	Min.	Typ.	Max.	Units
V_{ISO}	Isolation Voltage RMS, $f=50\text{Hz}$, $t=1\text{min}$	2500			V
L_{CE}	Stray Inductance		60		nH
$R_{CC'+EE'}$ $R_{AA'+CC'}$	Module Lead Resistance, Terminal to Chip @ $T_C=25^\circ\text{C}$		4.00 2.00		m Ω
$R_{\theta JC}$	Junction-to-Case (per IGBT-inverter) Junction-to-Case (per Diode-inverter) Junction-to-Case (per Diode-rectifier) Junction-to-Case (per IGBT-brake-chopper) Junction-to-Case (per Diode-brake-chopper)			0.708 0.975 1.151 0.987 1.684	K/W
$R_{\theta CS}$	Case-to-Sink (per IGBT-inverter) Case-to-Sink (per Diode-inverter) Case-to-Sink (per Diode-rectifier) Case-to-Sink (per IGBT-brake-chopper) Case-to-Sink (per Diode-brake-chopper)		0.304 0.418 0.494 0.423 0.722		
$R_{\theta CS}$	Case-to-Sink (Conductive grease applied)		0.02		K/W
T_{jmax}	Maximum Junction Temperature (inverter, brake) Maximum Junction Temperature(rectifier)			175 150	$^\circ\text{C}$
T_{jop}	Operating Junction Temperature (inverter, brake) Operating Junction Temperature(rectifier)	-40 -40		150 125	$^\circ\text{C}$
T_{STG}	Storage Temperature Range	-40		125	$^\circ\text{C}$
Mounting Torque	Mounting Screw:M5	3.0		6.0	N.m
G	Weight of Module		180		g

IGBT-inverter Output Characteristics

$V_{GE}=15V$

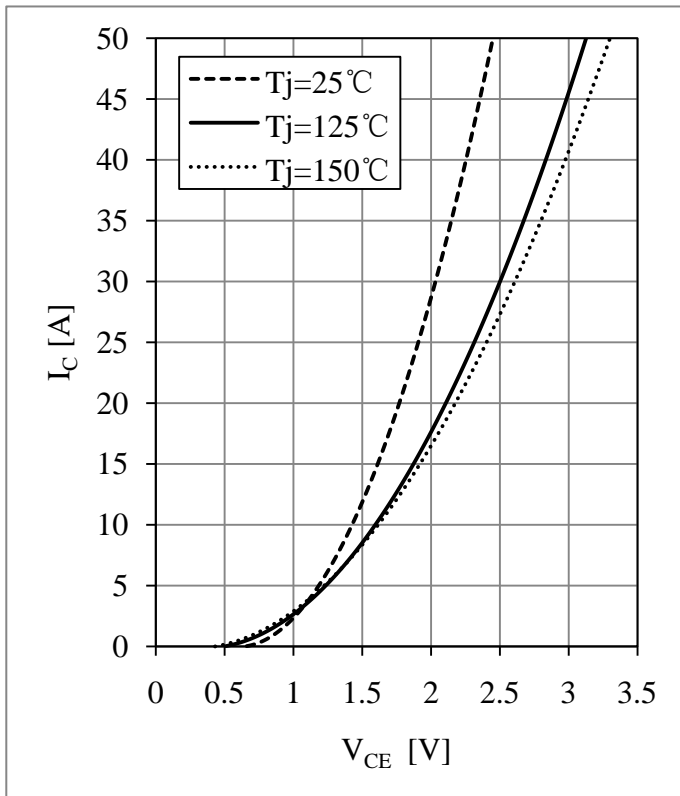

IGBT-inverter Transfer Characteristics

$V_{CE}=20V$

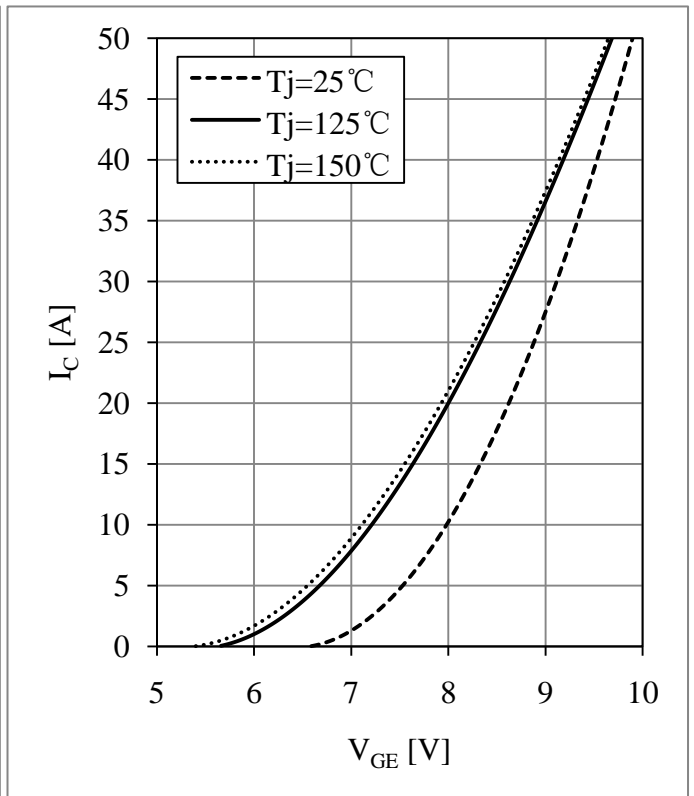

IGBT-inverter Switching Loss vs. I_C

$V_{CC}=600V, R_G=33\Omega, V_{GE}=\pm 15V$

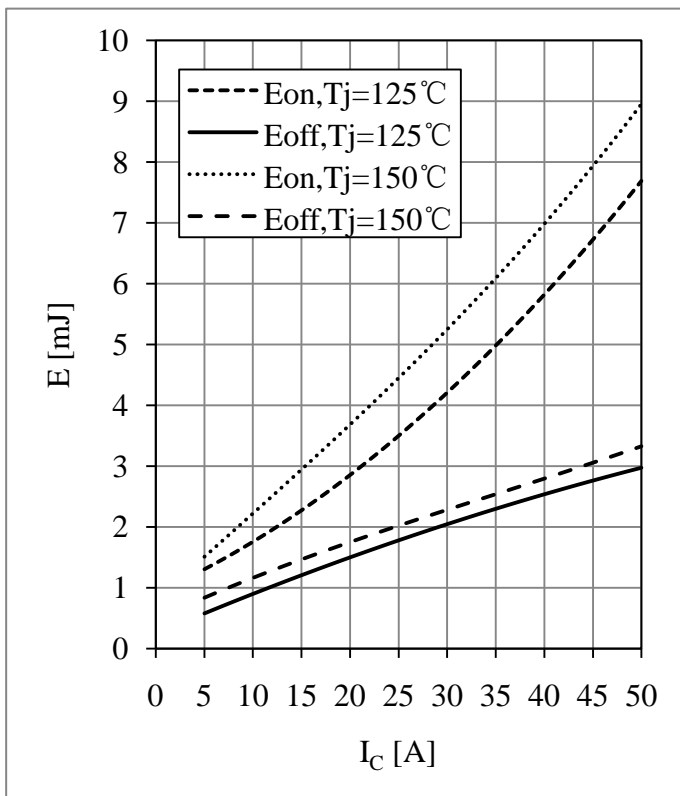

IGBT-inverter Switching Loss vs. R_G

$V_{CC}=600V, I_C=25A, V_{GE}=\pm 15V$

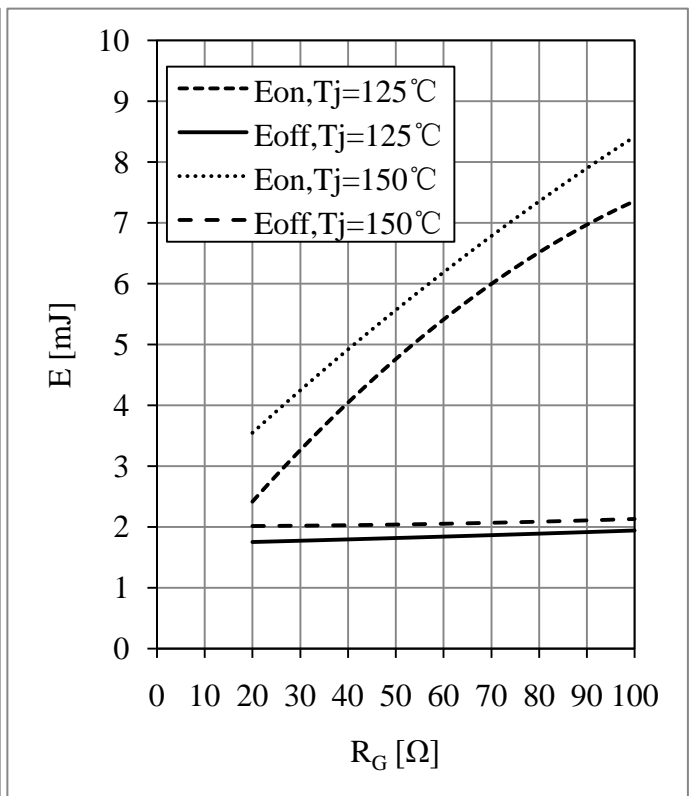

IGBT-inverter RBSOA
Module, $R_G=33\Omega, V_{GE}=\pm 15V, T_j=150^\circ C$

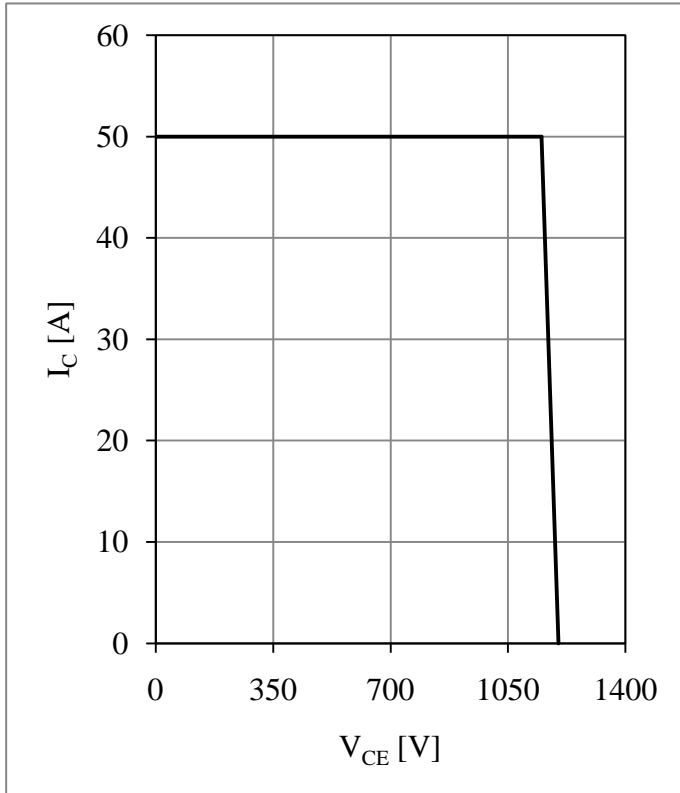

IGBT-inverter Transient Thermal Impedance

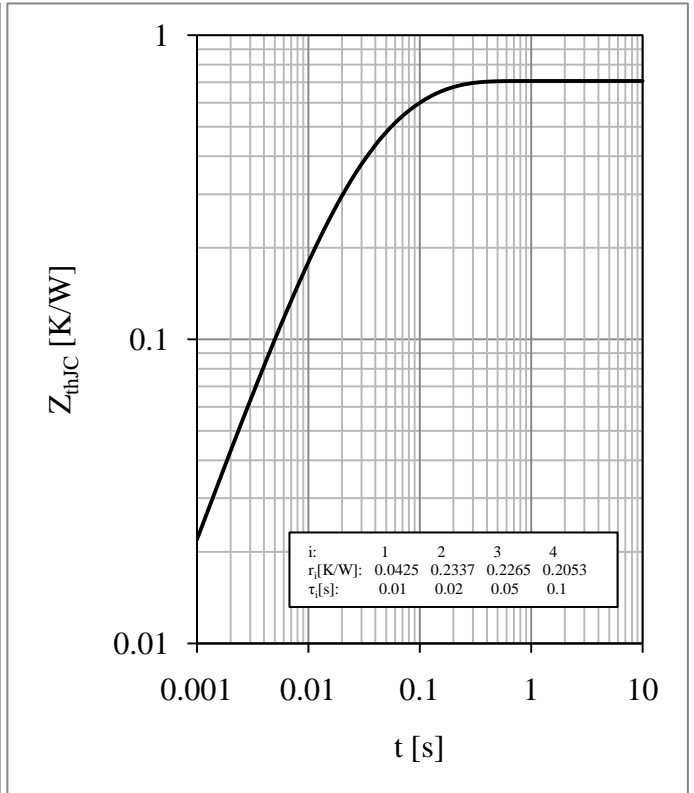

Diode-inverter Forward Characteristics

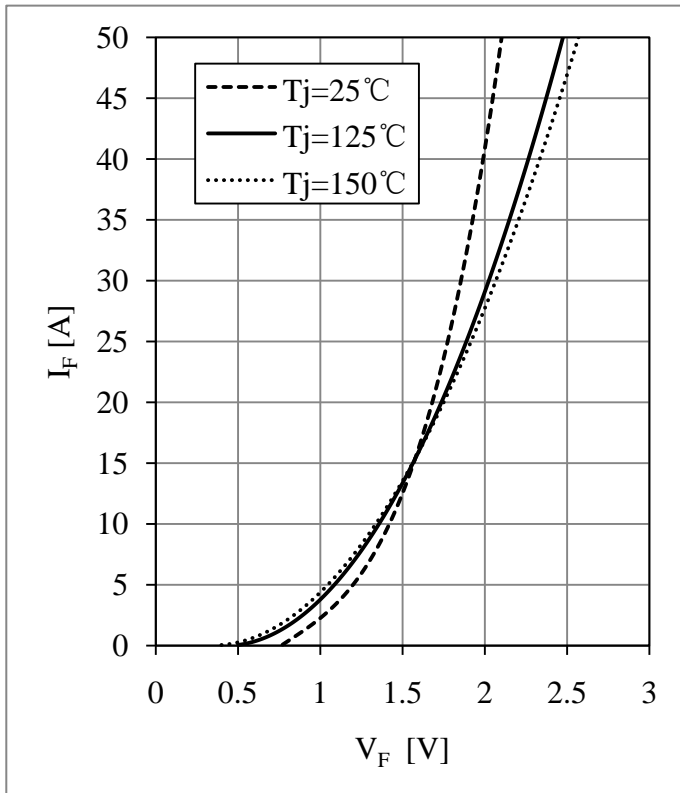

Diode-inverter Switching Loss vs. I_F
 $V_{CC}=600V, R_G=33\Omega$

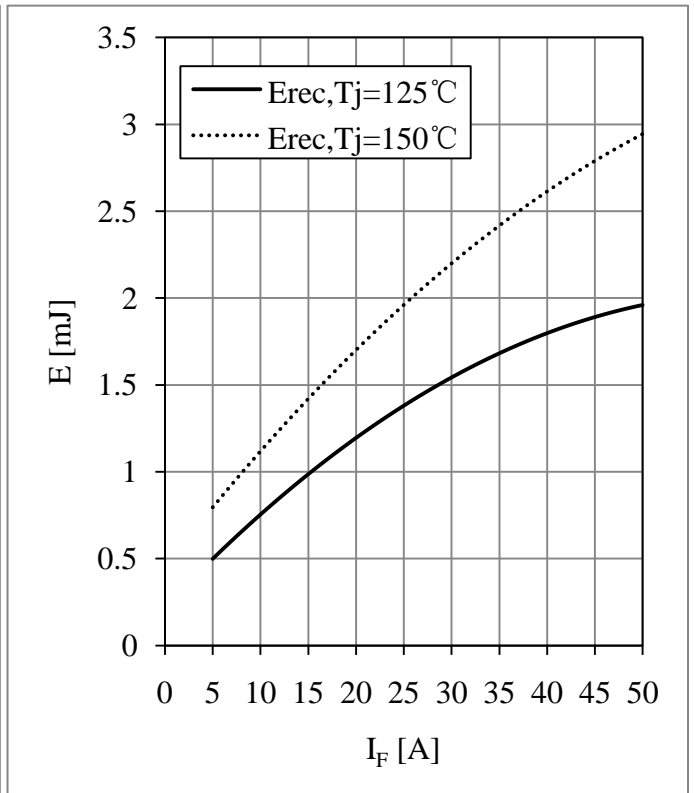

Diode-inverter Switching Loss vs. R_G
 $V_{CC}=600V, I_F=25A$

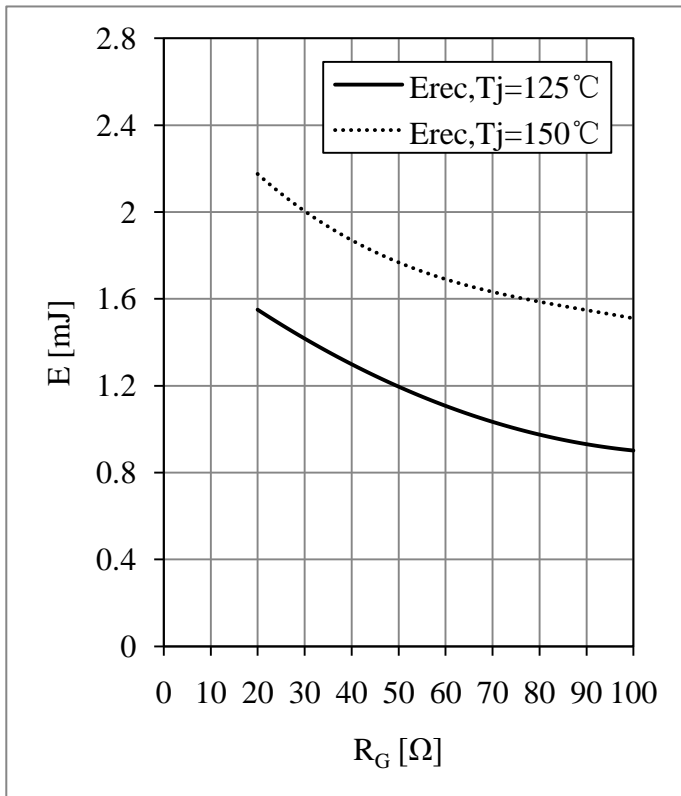

Diode-inverter Transient Thermal Impedance

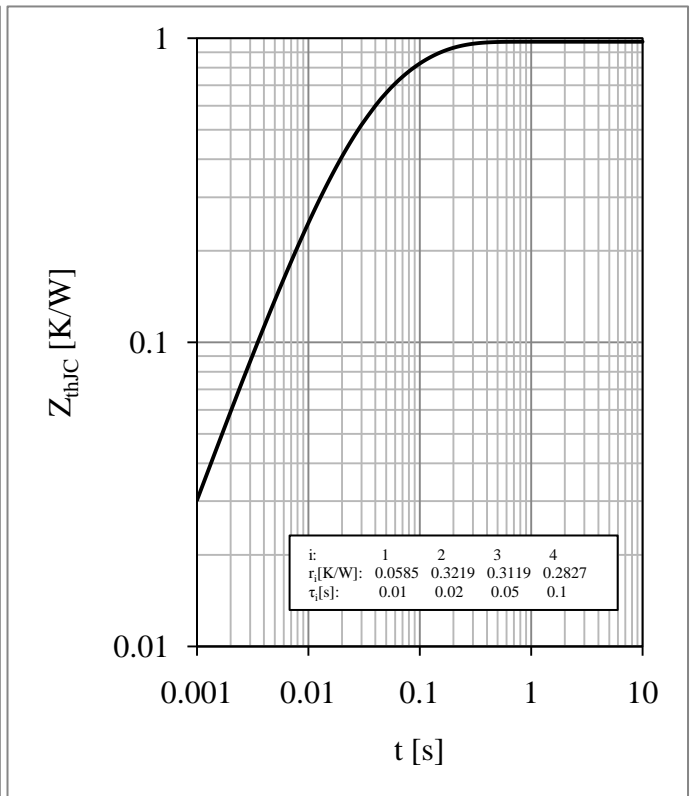

Diode-rectifier Forward Characteristics

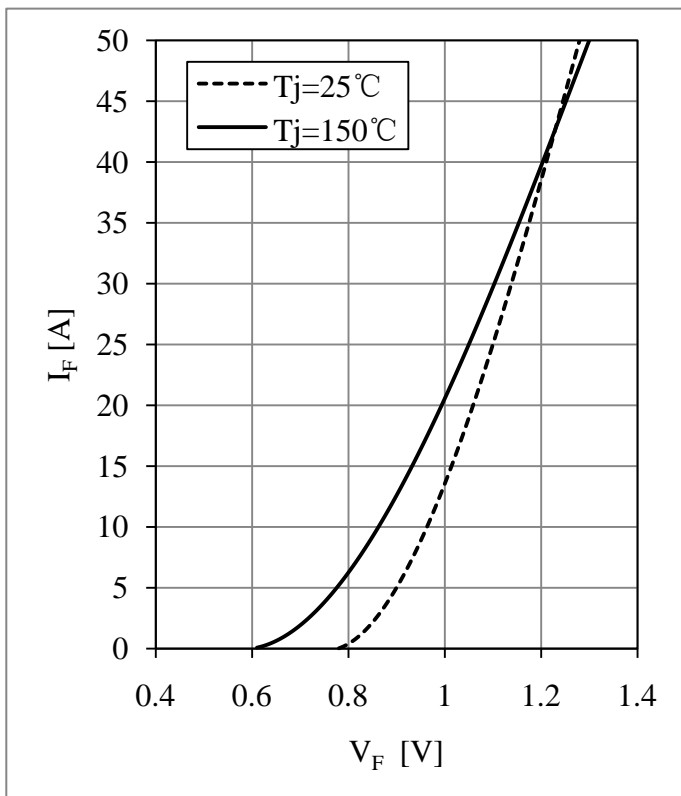

IGBT-brake-chopper Output Characteristics
 $V_{GE}=15V$

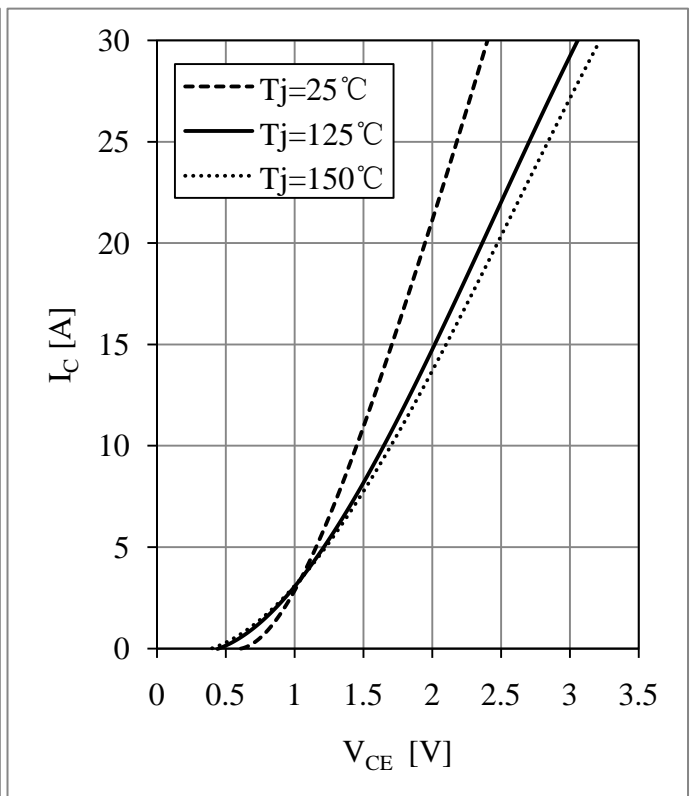

Diode-brake-chopper Forward Characteristics

NTC Temperature Characteristic

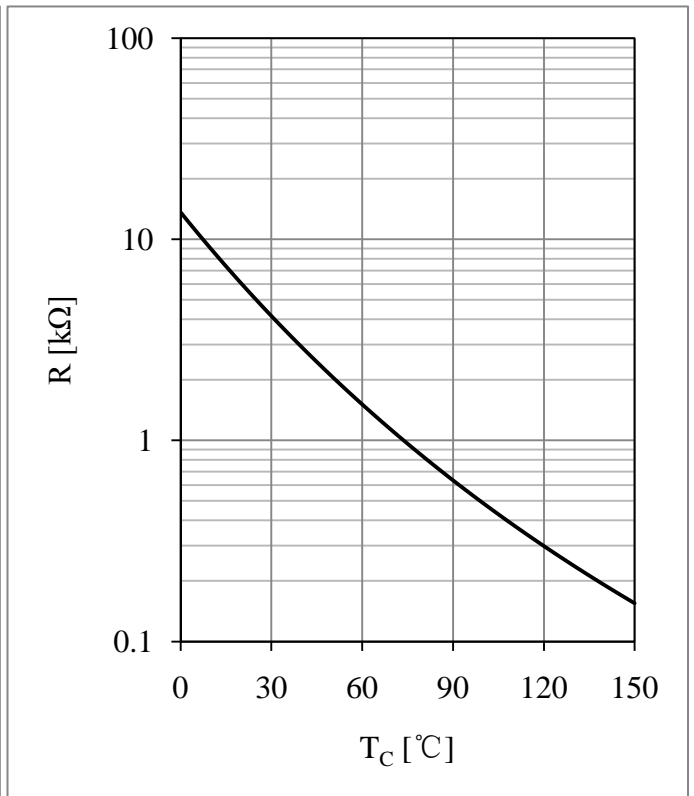
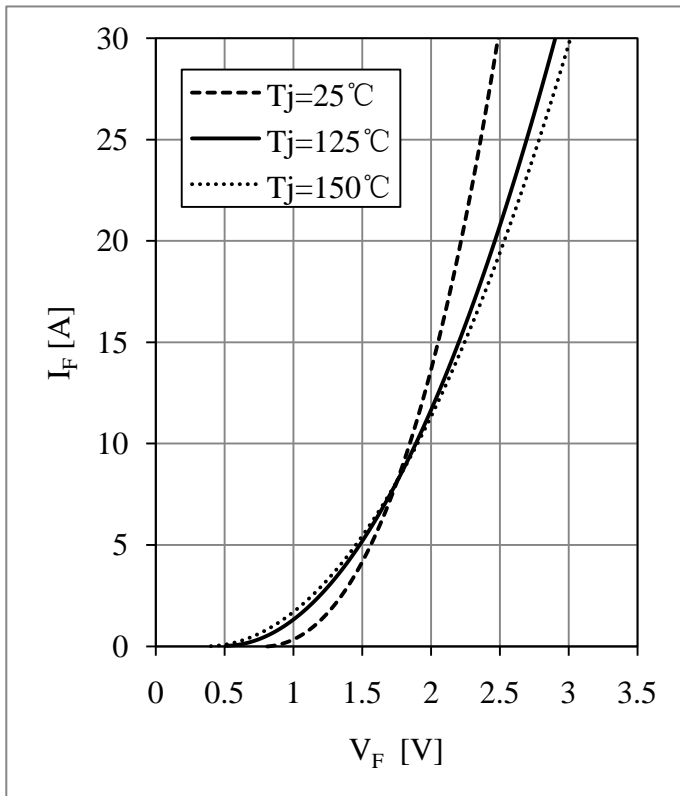

Equivalent Circuit Schematic

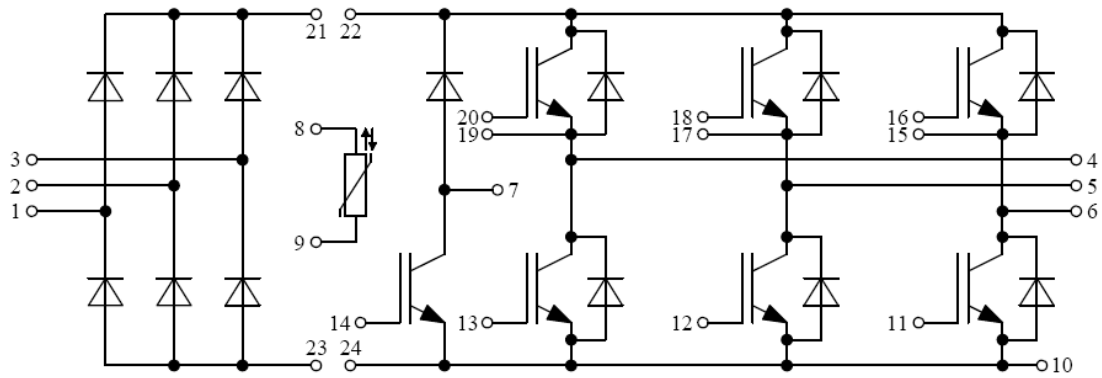

Package Dimensions

Dimensions in Millimeters

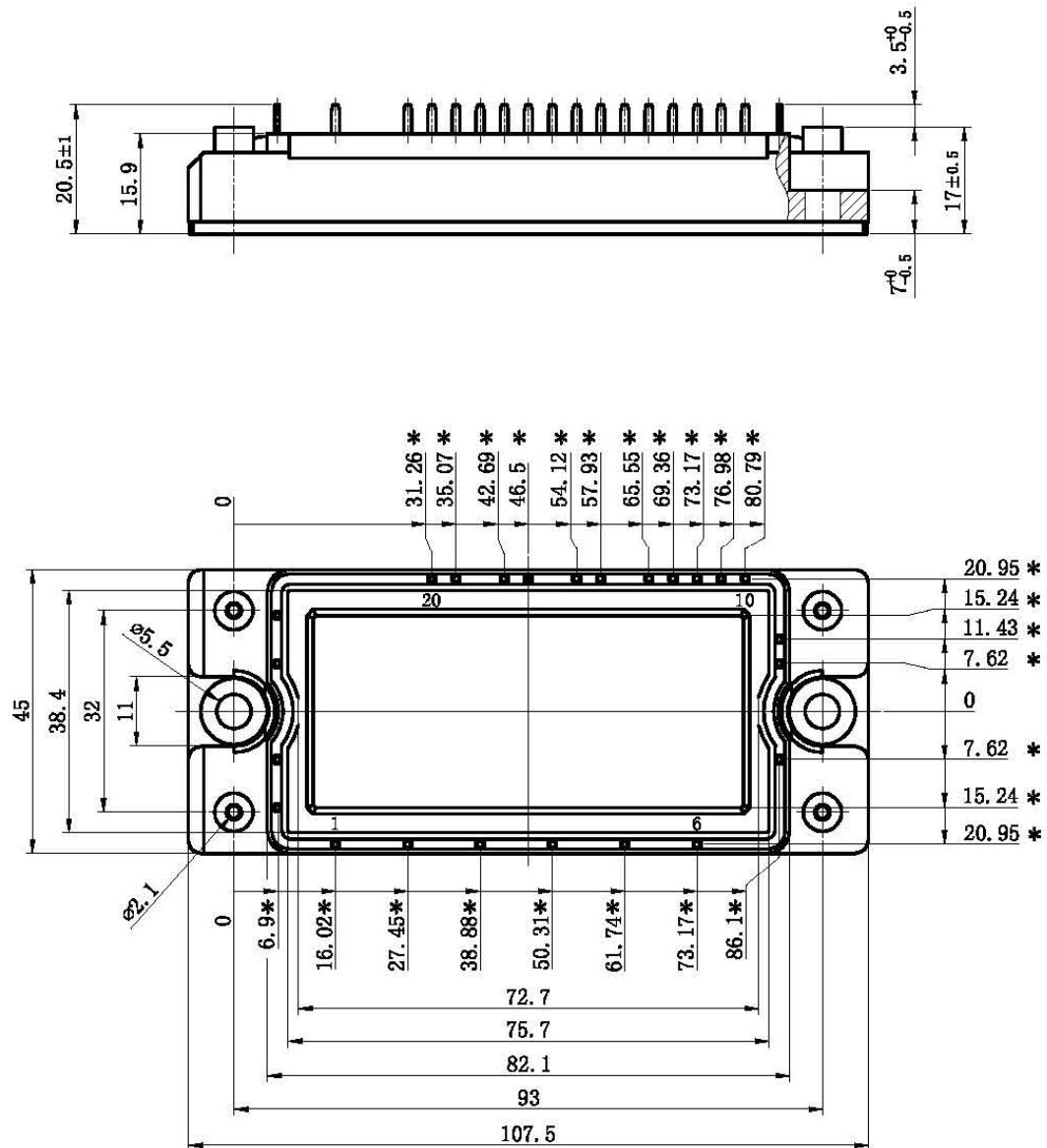

Terms and Conditions of Usage

The data contained in this product datasheet is exclusively intended for technically trained staff. you and your technical departments will have to evaluate the suitability of the product for the intended application and the completeness of the product data with respect to such application.

This product data sheet is describing the characteristics of this product for which a warranty is granted. Any such warranty is granted exclusively pursuant the terms and conditions of the supply agreement. There will be no guarantee of any kind for the product and its characteristics.

Should you require product information in excess of the data given in this product data sheet or which concerns the specific application of our product, please contact the sales office, which is responsible for you (see www.powersemi.cc), For those that are specifically interested we may provide application notes.

Due to technical requirements our product may contain dangerous substances. For information on the types in question please contact the sales office, which is responsible for you.

Should you intend to use the Product in aviation applications, in health or live endangering or life support applications, please notify.

If and to the extent necessary, please forward equivalent notices to your customers.
Changes of this product data sheet are reserved.