

STARPOWER

SEMICONDUCTOR

IGBT

GD20PJK60F1S

Molding Type Module

600V/20A PIM in one-package

General Description

STARPOWER IGBT Power Module provides ultra low conduction and switching loss as well as short circuit ruggedness. They are designed for the applications such as general inverters and UPS.

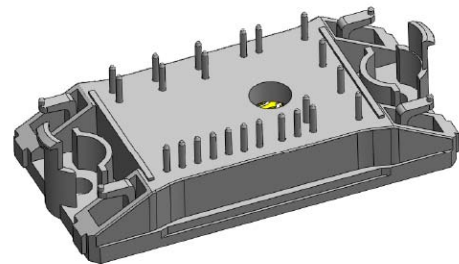

Features

- Low $V_{CE(sat)}$ NPT IGBT technology
- 10 μ s short circuit capability
- Square RBSOA
- $V_{CE(sat)}$ with positive temperature coefficient
- Fast & soft reverse recovery anti-parallel FWD

Typical Applications

- Inverter for motor drive
- AC and DC servo drive amplifier
- Uninterruptible power supply

IGBT-inverter $T_C=25^\circ\text{C}$ unless otherwise noted**Maximum Rated Values**

Symbol	Description	GD20PJK60F1S	Units
V_{CES}	Collector-Emitter Voltage @ $T_j=25^\circ\text{C}$	600	V
V_{GES}	Gate-Emitter Voltage @ $T_j=25^\circ\text{C}$	± 20	V
I_C	Collector Current @ $T_C=25^\circ\text{C}$	40	A
	@ $T_C=80^\circ\text{C}$	20	
I_{CM}	Pulsed Collector Current $t_p=1\text{ms}$	40	A
P_{tot}	Total Power Dissipation @ $T_j=150^\circ\text{C}$	106	W

Off Characteristics

Symbol	Parameter	Test Conditions	Min.	Typ.	Max.	Units
$V_{(BR)CES}$	Collector-Emitter Breakdown Voltage	$T_j=25^\circ\text{C}$	600			V
I_{CES}	Collector Cut-Off Current	$V_{CE}=V_{CES}, V_{GE}=0\text{V}, T_j=25^\circ\text{C}$			1.0	mA
I_{GES}	Gate-Emitter Leakage Current	$V_{GE}=V_{GES}, V_{CE}=0\text{V}, T_j=25^\circ\text{C}$			400	nA

On Characteristics

Symbol	Parameter	Test Conditions	Min.	Typ.	Max.	Units
$V_{GE(th)}$	Gate-Emitter Threshold Voltage	$I_C=250\mu\text{A}, V_{CE}=V_{GE}, T_j=25^\circ\text{C}$	3.5	4.5	5.5	V
$V_{CE(sat)}$	Collector to Emitter Saturation Voltage	$I_C=20\text{A}, V_{GE}=15\text{V}, T_j=25^\circ\text{C}$		1.80	2.25	V
		$I_C=20\text{A}, V_{GE}=15\text{V}, T_j=125^\circ\text{C}$		2.10		

Switching Characteristics

Symbol	Parameter	Test Conditions	Min.	Typ.	Max.	Units
$t_{d(on)}$	Turn-On Delay Time	$V_{CC}=300V, I_C=20A,$ $R_G=16\Omega, V_{GE}=\pm 15V,$ $T_j=25^\circ C$		70		ns
t_r	Rise Time			21		ns
$t_{d(off)}$	Turn-Off Delay Time			113		ns
t_f	Fall Time			119		ns
E_{on}	Turn-On Switching Loss			0.34		mJ
E_{off}	Turn-Off Switching Loss			0.26		mJ
$t_{d(on)}$	Turn-On Delay Time	$V_{CC}=300V, I_C=20A,$ $R_G=16\Omega, V_{GE}=\pm 15V,$ $T_j=125^\circ C$		84		ns
t_r	Rise Time			31		ns
$t_{d(off)}$	Turn-Off Delay Time			113		ns
t_f	Fall Time			141		ns
E_{on}	Turn-On Switching Loss			0.47		mJ
E_{off}	Turn-Off Switching Loss			0.39		mJ
C_{ies}	Input Capacitance	$V_{CE}=30V, f=1Mhz,$ $V_{GE}=0V$		1240		pF
C_{oes}	Output Capacitance			124		pF
C_{res}	Reverse Transfer Capacitance			44		pF
Q_G	Gate Charge	$V_{CC}=400V, I_C=20A,$ $V_{GE}=15V$		71		nC
R_{Gint}	Internal Gate Resister			/		Ω
I_{SC}	SC Data	$t_p \leq 10\mu s, V_{GE}=15V,$ $T_j=125^\circ C, V_{CC}=400V,$ $V_{CEM} \leq 600V$		180		A

Diode-inverter $T_C=25^\circ C$ unless otherwise noted

Maximum Rated Values

Symbol	Description	GD20PJK60F1S	Units
V_{RRM}	Repetitive Peak Reverse Voltage @ $T_j=25^\circ C$	600	V
I_F	DC Forward Current	20	A
I_{FRM}	Repetitive Peak Forward Current $t_p=1ms$	40	A

Characteristics Values

Symbol	Parameter	Test Conditions	Min.	Typ.	Max.	Units	
V_F	Diode Forward Voltage	$I_F=20A, V_{GE}=0V$	$T_j=25^\circ C$		1.30	1.75	V
			$T_j=125^\circ C$		1.25		
Q_r	Recovered Charge	$I_F=20A,$ $V_R=300V,$ $R_G=16\Omega,$ $V_{GE}=-15V$	$T_j=25^\circ C$		1.1		μC
			$T_j=125^\circ C$		1.7		
I_{RM}	Peak Reverse Recovery Current	$V_{GE}=-15V$	$T_j=25^\circ C$		32		A
			$T_j=125^\circ C$		37		
E_{rec}	Reverse Recovery Energy	$V_{GE}=-15V$	$T_j=25^\circ C$		0.27		mJ
			$T_j=125^\circ C$		0.43		

Diode-rectifier $T_C=25^\circ\text{C}$ unless otherwise noted**Maximum Rated Values**

Symbol	Description	GD30PIK60C5S	Units
V_{RRM}	Repetitive Peak Reverse Voltage @ $T_j=25^\circ\text{C}$	1600	V
$I_{F(AV)}$	Average On-state Current @ $T_C=100^\circ\text{C}$	20	A
I_{RMSM}	Maximum RMS Current At Rectifier Output @ $T_C=80^\circ\text{C}$	40	A
I_{FSM}	Surge Forward Current $V_R=0V, t_p=10\text{ms}, T_j=45^\circ\text{C}$	270	A
I^2t	I^2t -value, $V_R=0V, t_p=10\text{ms}, T_j=45^\circ\text{C}$	360	A^2s

Characteristics Values

Symbol	Parameter	Test Conditions	Min.	Typ.	Max.	Units
V_F	Diode Forward Voltage	$I_F=20\text{A}$ $T_j=150^\circ\text{C}$		1.11		V
I_R	Reverse Current	$T_j=150^\circ\text{C}, V_R=1600\text{V}$			1.0	mA

IGBT-brake-chopper $T_C=25^\circ\text{C}$ unless otherwise noted**Maximum Rated Values**

Symbol	Description	GD20PJK60F1S	Units
V_{CES}	Collector-Emitter Voltage @ $T_j=25^\circ\text{C}$	600	V
V_{GES}	Gate-Emitter Voltage @ $T_j=25^\circ\text{C}$	± 20	V
I_C	Collector Current @ $T_C=25^\circ\text{C}$ @ $T_C=80^\circ\text{C}$	26 15	A
I_{CM}	Pulsed Collector Current $t_p=1\text{ms}$	30	A
P_{tot}	Total Power Dissipation @ $T_j=175^\circ\text{C}$	82	W

Off Characteristics

Symbol	Parameter	Test Conditions	Min.	Typ.	Max.	Units
$V_{(BR)CES}$	Collector-Emitter Breakdown Voltage	$T_j=25^\circ\text{C}$	600			V
I_{CES}	Collector Cut-Off Current	$V_{CE}=V_{CES}, V_{GE}=0V,$ $T_j=25^\circ\text{C}$			1.0	mA
I_{GES}	Gate-Emitter Leakage Current	$V_{GE}=V_{GES}, V_{CE}=0V,$ $T_j=25^\circ\text{C}$			400	nA

On Characteristics

Symbol	Parameter	Test Conditions	Min.	Typ.	Max.	Units
$V_{GE(th)}$	Gate-Emitter Threshold Voltage	$I_C=250\mu\text{A}, V_{CE}=V_{GE},$ $T_j=25^\circ\text{C}$	3.5	4.5	5.5	V
$V_{CE(sat)}$	Collector to Emitter Saturation Voltage	$I_C=15\text{A}, V_{GE}=15\text{V},$ $T_j=25^\circ\text{C}$		1.80	2.25	V
		$I_C=15\text{A}, V_{GE}=15\text{V},$ $T_j=125^\circ\text{C}$		2.05		

Switching Characteristics

Symbol	Parameter	Test Conditions	Min.	Typ.	Max.	Units
$t_{d(on)}$	Turn-On Delay Time	$V_{CC}=400V, I_C=15A,$ $R_G=16\Omega, V_{GE}=\pm 15V,$ $T_j=25^\circ C$		60		ns
t_r	Rise Time			20		ns
$t_{d(off)}$	Turn-Off Delay Time			88		ns
t_f	Fall Time			135		ns
E_{on}	Turn-On Switching Loss			0.24		mJ
E_{off}	Turn-Off Switching Loss			0.18		mJ
$t_{d(on)}$	Turn-On Delay Time	$V_{CC}=400V, I_C=15A,$ $R_G=16\Omega, V_{GE}=\pm 15V,$ $T_j=125^\circ C$		60		ns
t_r	Rise Time			22		ns
$t_{d(off)}$	Turn-Off Delay Time			97		ns
t_f	Fall Time			145		ns
E_{on}	Turn-On Switching Loss			0.39		mJ
E_{off}	Turn-Off Switching Loss			0.26		mJ
C_{ies}	Input Capacitance	$V_{CE}=30V, f=1Mhz,$ $V_{GE}=0V$		850		pF
C_{oes}	Output Capacitance			75		pF
C_{res}	Reverse Transfer Capacitance			35		pF
Q_G	Gate Charge	$V_{CC}=400V, I_C=15A,$ $V_{GE}=15V$		56		nC
R_{Gint}	Internal Gate Resister			/		Ω
I_{SC}	SC Data	$t_p \leq 10\mu s, V_{GE}=15V,$ $T_j=125^\circ C, V_{CC}=400V,$ $V_{CEM} \leq 600V$		135		A

Diode-brake-chopper $T_C=25^\circ C$ unless otherwise noted**Maximum Rated Values**

Symbol	Description	GD20PJK60F1S	Units
V_{RRM}	Repetitive Peak Reverse Voltage @ $T_j=25^\circ C$	600	V
I_F	DC Forward Current	15	A
I_{FRM}	Repetitive Peak Forward Current $t_p=1ms$	30	A

Characteristics Values

Symbol	Parameter	Test Conditions	Min.	Typ.	Max.	Units	
V_F	Diode Forward Voltage	$I_F=15A, V_{GE}=0V$	$T_j=25^\circ C$		1.20	1.60	V
			$T_j=125^\circ C$		1.15		
Q_r	Recovered Charge	$I_F=15A,$ $V_R=300V,$ $R_G=16\Omega,$ $V_{GE}=-15V$	$T_j=25^\circ C$		0.9		μC
			$T_j=125^\circ C$		1.4		
I_{RM}	Peak Reverse Recovery Current	$V_{GE}=-15V$	$T_j=25^\circ C$		27		A
			$T_j=125^\circ C$		31		
E_{rec}	Reverse Recovery Energy	$V_{GE}=-15V$	$T_j=25^\circ C$		0.23		mJ
			$T_j=125^\circ C$		0.36		

NTC $T_C=25^\circ\text{C}$ unless otherwise noted

Symbol	Parameter	Test Conditions	Min.	Typ.	Max.	Units
R_{25}	Rated Resistance			22.0		$\text{k}\Omega$
$\Delta R/R$	Deviation of R_{100}	$T_C=100^\circ\text{C}, R_{100}=1486.1\Omega$	-5		5	%
P_{25}	Power Dissipation				200	mW
$B_{25/50}$	B-value	$R_2=R_{25}\exp[B_{25/50}(1/T_2-1/(298.15\text{K}))]$		4000		K

IGBT Module

Symbol	Parameter	Min.	Typ.	Max.	Units
V_{ISO}	Isolation Voltage RMS, $f=50\text{Hz}, t=1\text{min}$	4000			V
$R_{\theta\text{JC}}$	Junction-to-Case (per IGBT-inverter)			1.182	K/W
	Junction-to-Case (per Diode-inverter)			2.578	
	Junction-to-Case (per Diode-rectifier)			1.611	
	Junction-to-Case (per IGBT-brake-chopper)			1.533	
	Junction-to-Case (per Diode-brake-chopper)			2.812	
$R_{\theta\text{CS}}$	Case-to-Sink (Conductive grease applied)		0.036		K/W
T_{jmax}	Maximum Junction Temperature			150	$^\circ\text{C}$
T_{jop}	Operating Junction Temperature	-40		125	$^\circ\text{C}$
T_{STG}	Storage Temperature Range	-40		125	$^\circ\text{C}$

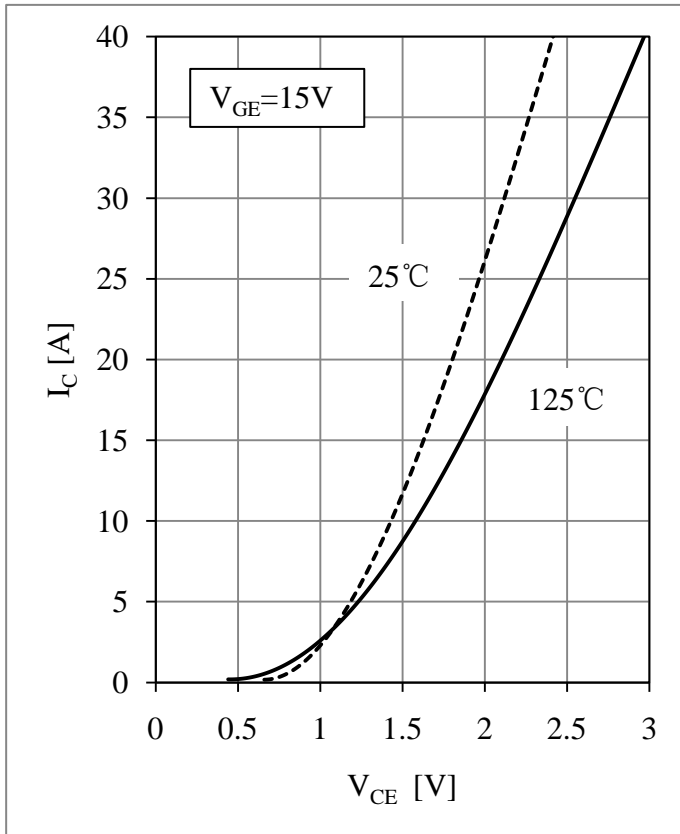

Fig 1. IGBT-inverter Output Characteristic

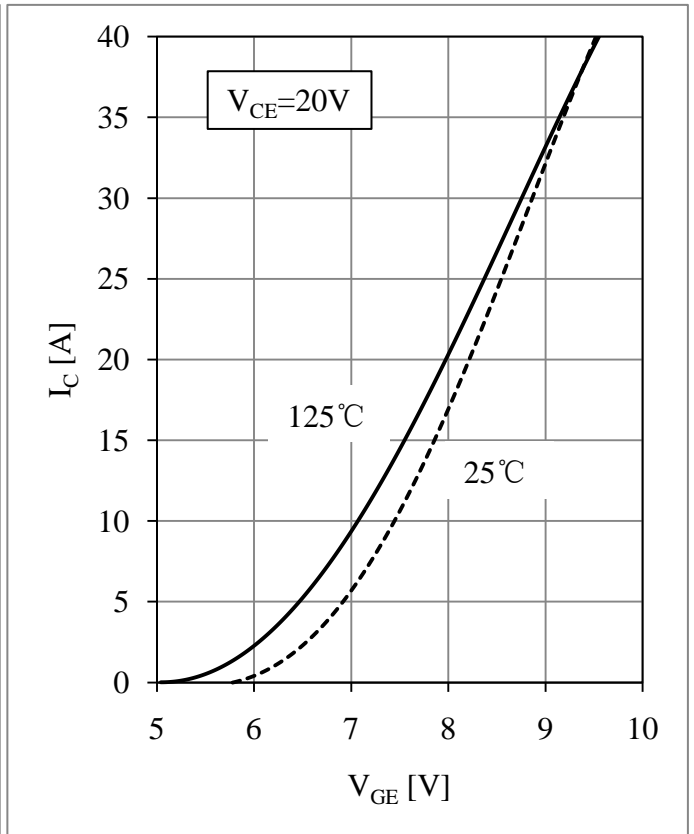

Fig 2. IGBT-inverter Transfer Characteristic

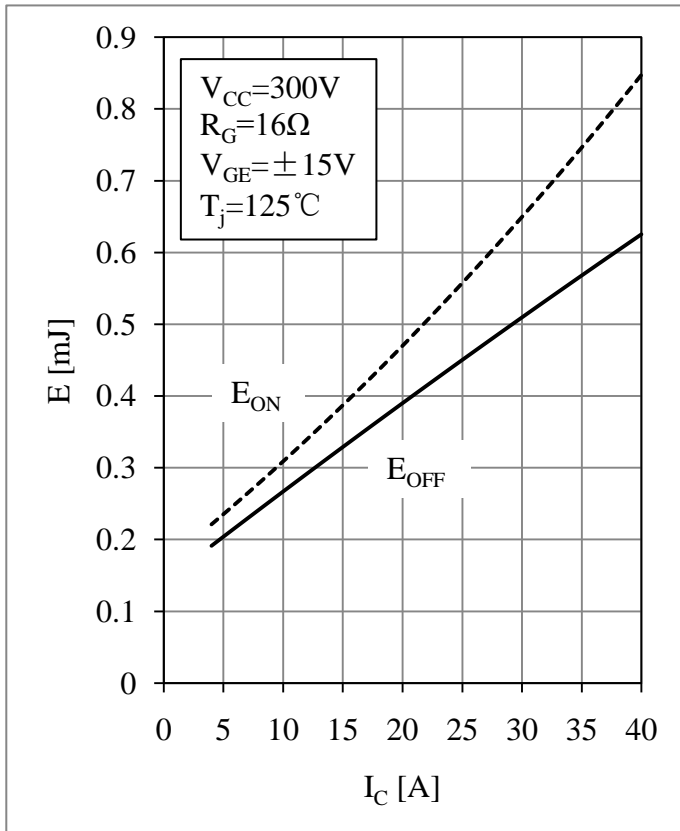

Fig 3. IGBT-inverter Switching Loss vs. I_C

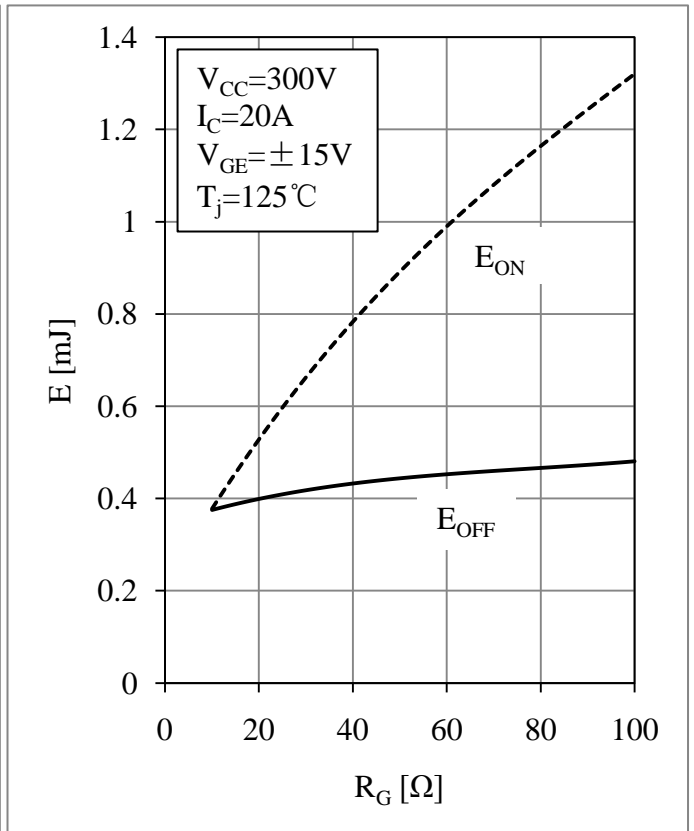

Fig 4. IGBT-inverter Switching Loss vs. R_G

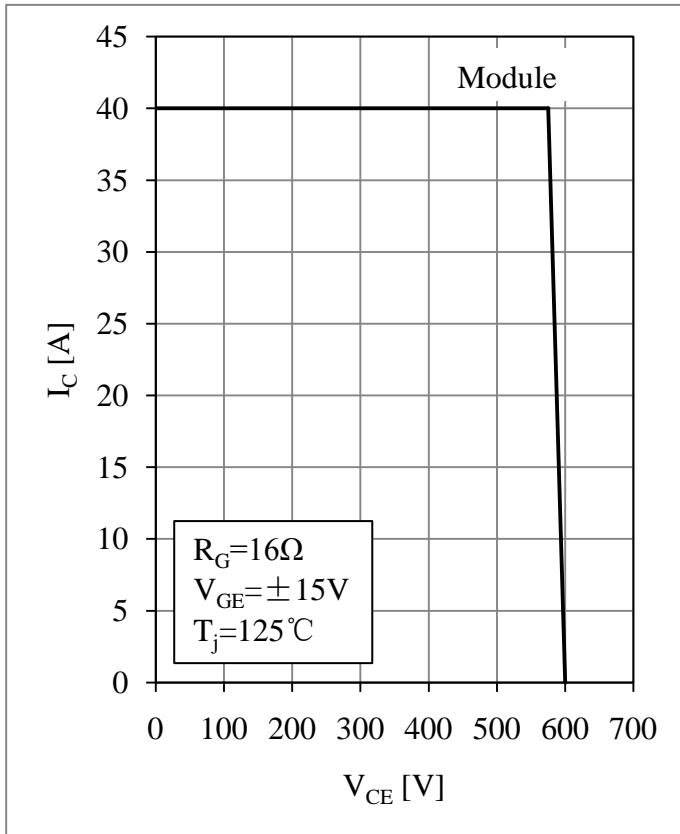

Fig 5. IGBT-inverter RBSOA

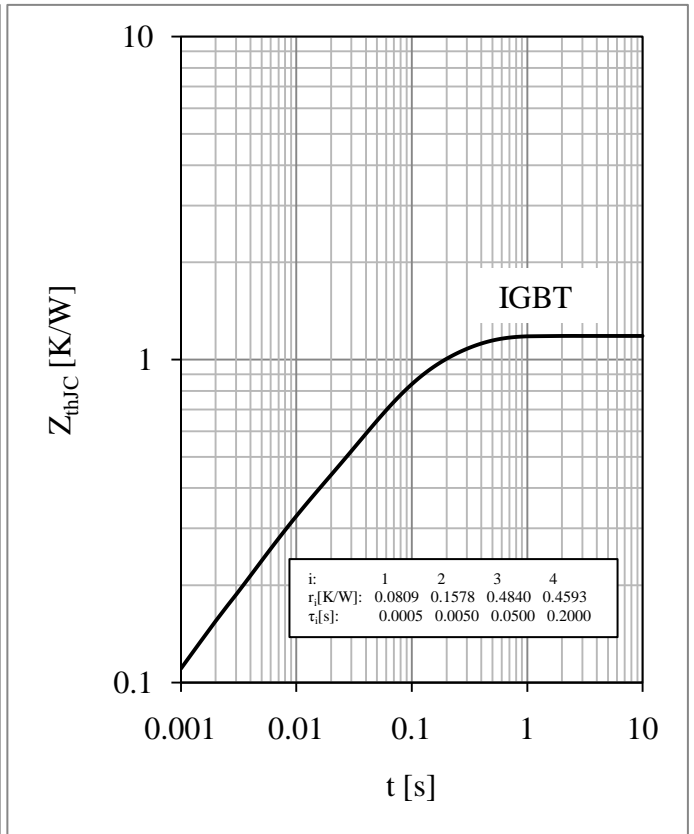

Fig 6. IGBT-inverter Transient Thermal Impedance

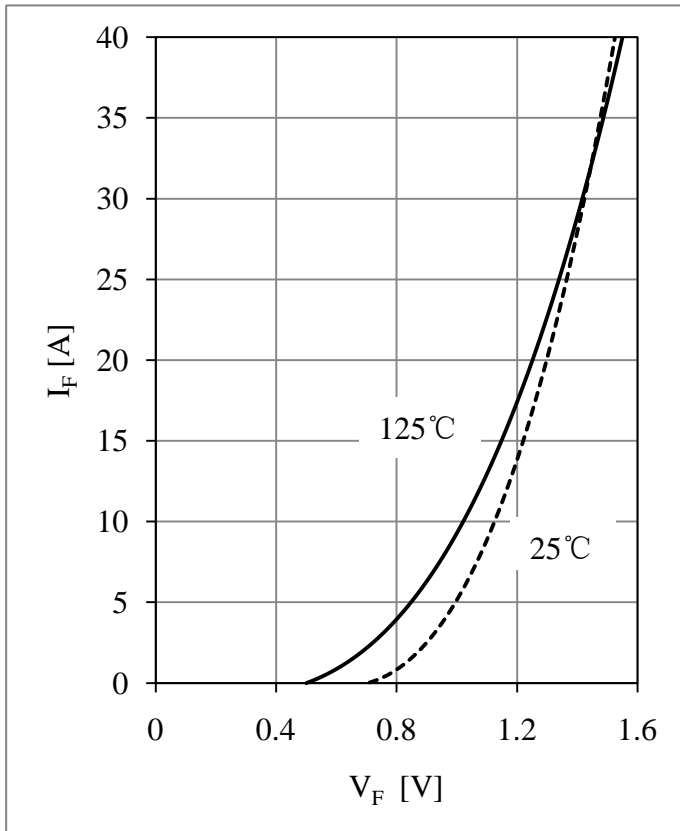

Fig 7. Diode-inverter Forward Characteristic

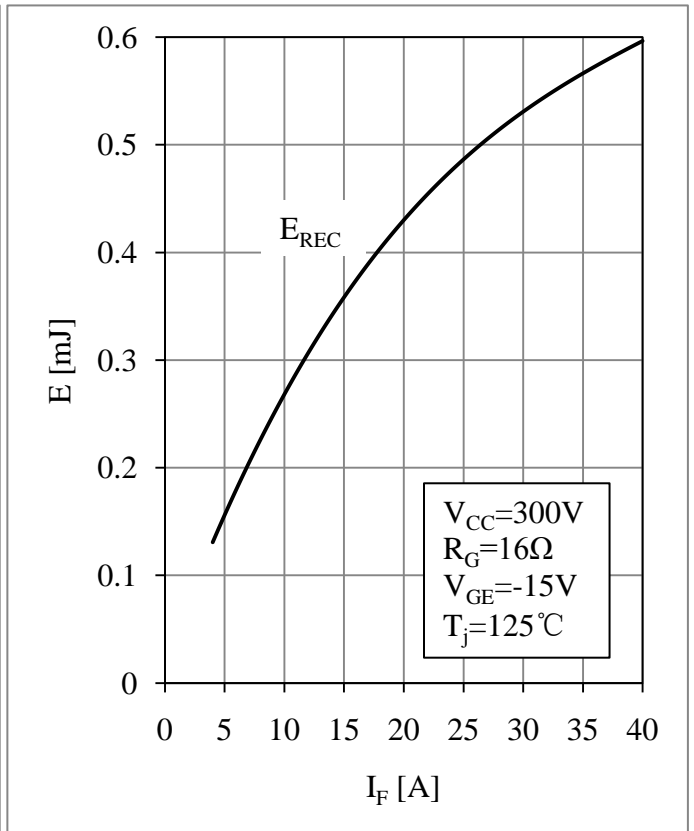

Fig 8. Diode-inverter Switching Loss vs. I_F

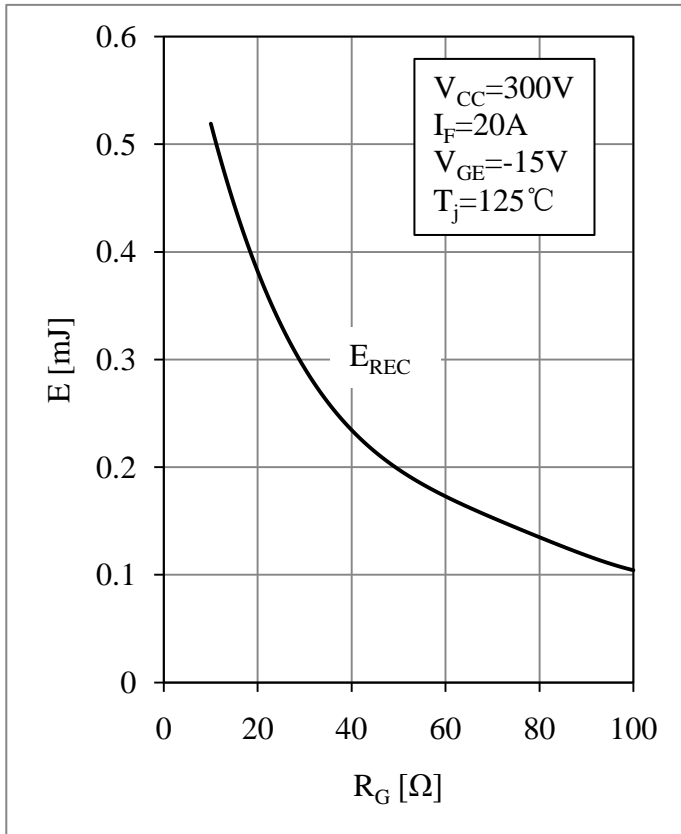

Fig 9. Diode-inverter Switching Loss vs. R_G

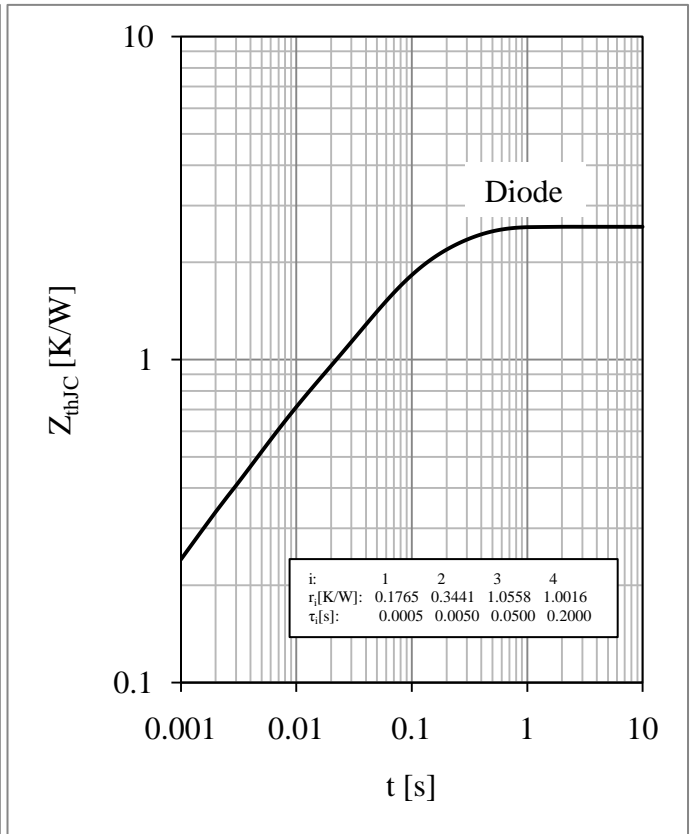

Fig 10. Diode-inverter Transient Thermal Impedance

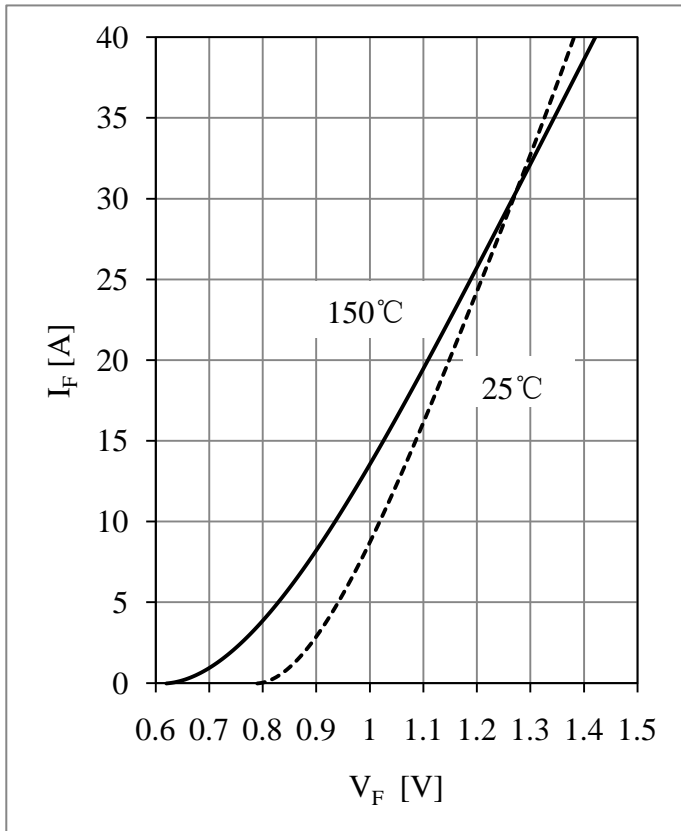

Fig 11. Diode-rectifier Forward Characteristic

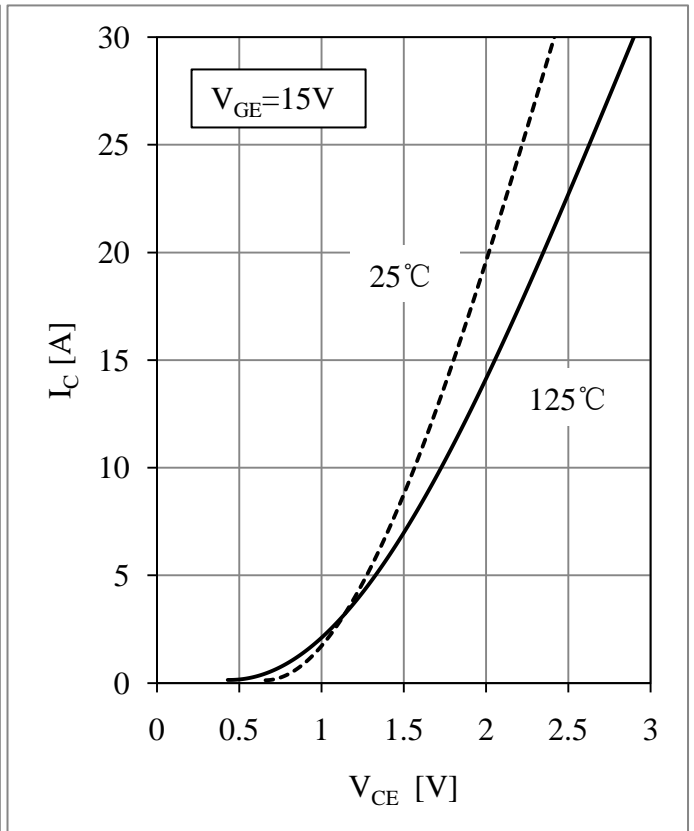

Fig 12. IGBT-brake-chopper Output Characteristic

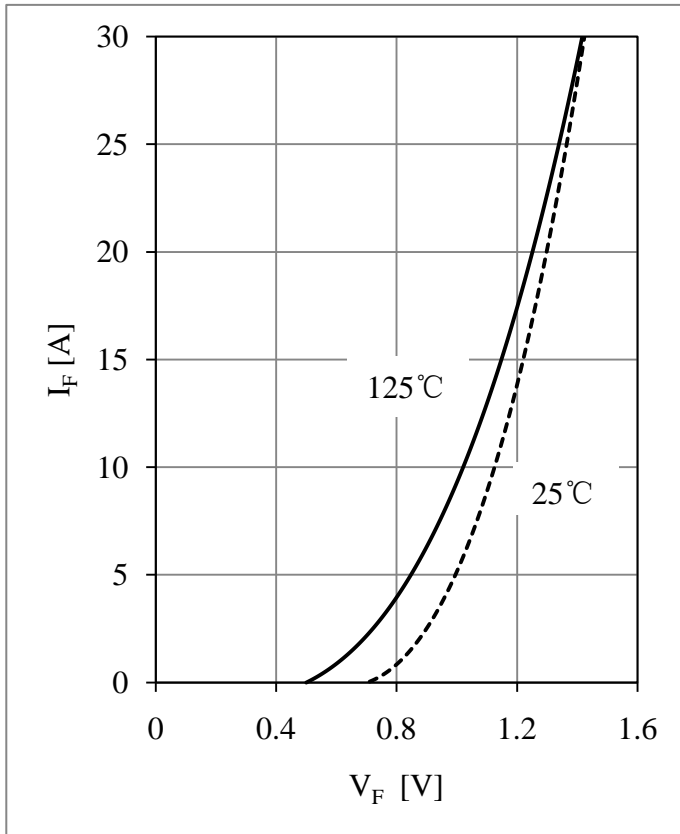

Fig 13. Diode-brake-chopper Forward Characteristic

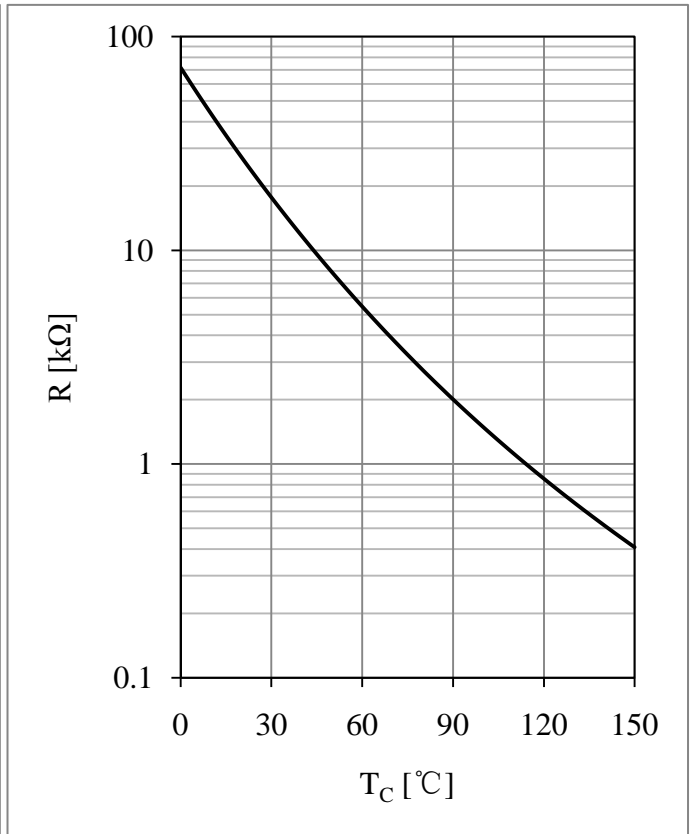
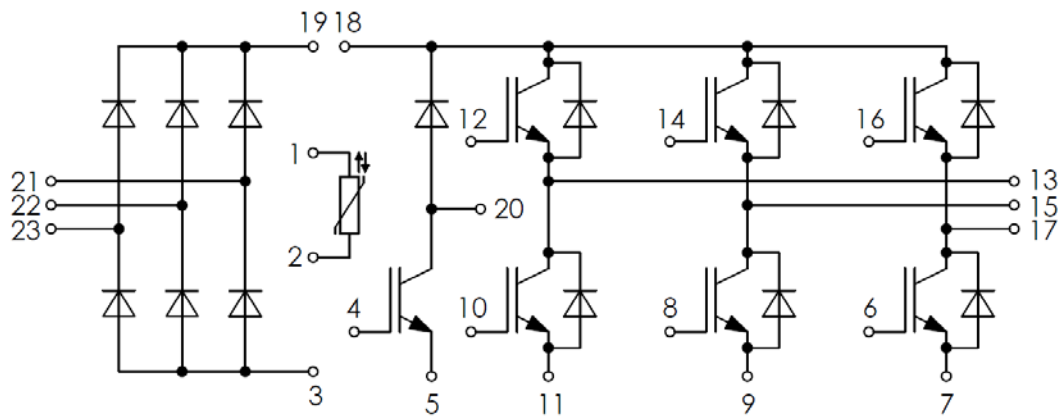

Fig 14. NTC Temperature Characteristic

Equivalent Circuit Schematic



Package Dimensions

Dimensions in Millimeters

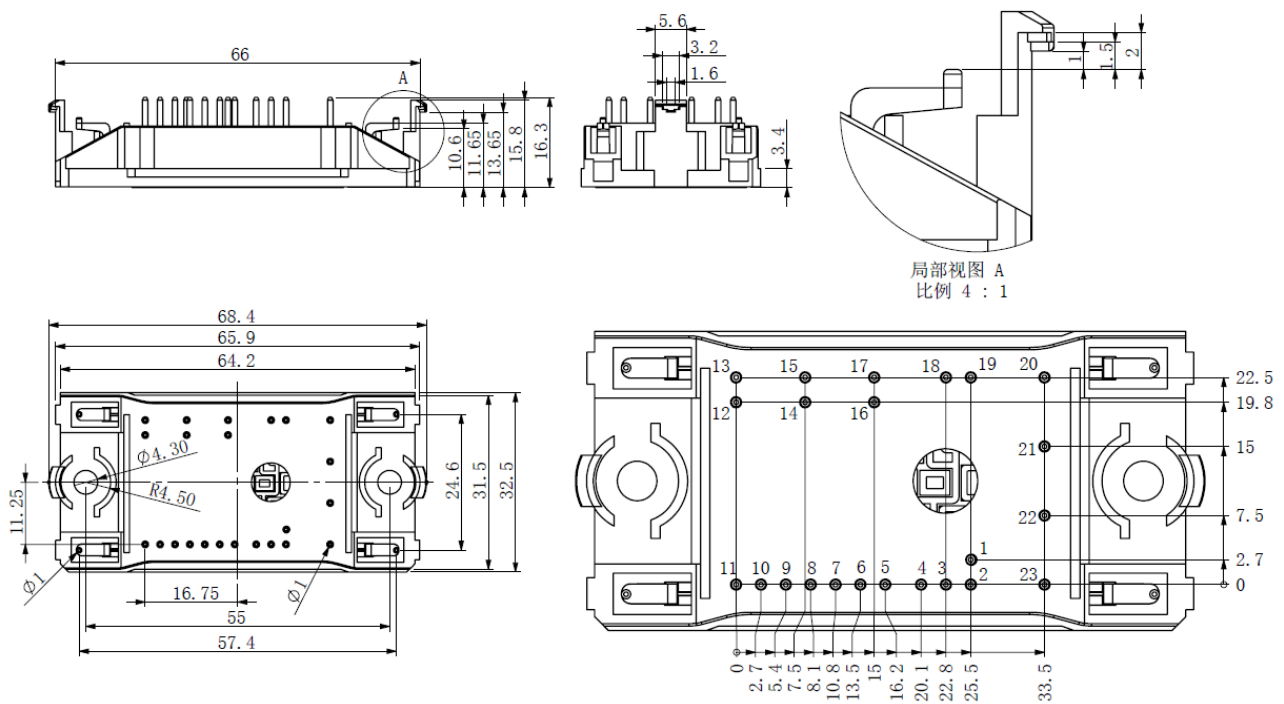

局部视图 A
比例 4 : 1

Terms and Conditions of Usage

The data contained in this product datasheet is exclusively intended for technically trained staff. you and your technical departments will have to evaluate the suitability of the product for the intended application and the completeness of the product data with respect to such application.

This product data sheet is describing the characteristics of this product for which a warranty is granted. Any such warranty is granted exclusively pursuant the terms and conditions of the supply agreement. There will be no guarantee of any kind for the product and its characteristics.

Should you require product information in excess of the data given in this product data sheet or which concerns the specific application of our product, please contact the sales office, which is responsible for you (see www.powersemi.cc), For those that are specifically interested we may provide application notes.

Due to technical requirements our product may contain dangerous substances. For information on the types in question please contact the sales office, which is responsible for you.

Should you intend to use the Product in aviation applications, in health or live endangering or life support applications, please notify.

If and to the extent necessary, please forward equivalent notices to your customers.
Changes of this product data sheet are reserved.