

# STARPOWER

SEMICONDUCTOR

**IGBT**

## GD200MLY120C2S

**1200V/200A 3-level in one-package**

### General Description

STARPOWER IGBT Power Module provides ultra low conduction loss as well as short circuit ruggedness.

They are designed for the applications such as UPS.

### Features

- Low  $V_{CE(sat)}$  Trench IGBT technology
- $V_{CE(sat)}$  with positive temperature coefficient
- Low switching loss
- Maximum junction temperature 175°C
- Low inductance case
- Fast & soft reverse recovery anti-parallel FWD
- Isolated copper baseplate using DBC technology

### Typical Applications

- Inverter for motor drive
- Uninterruptible power supply
- Solar power

### Equivalent Circuit Schematic

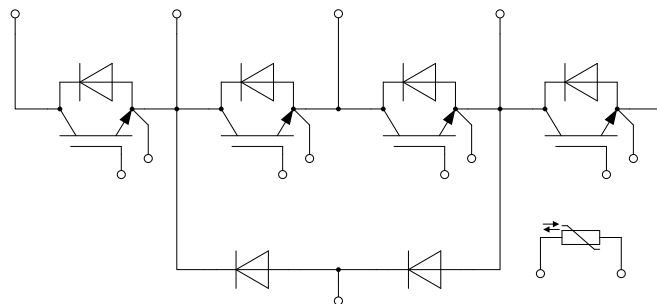

**Absolute Maximum Ratings**  $T_C=25^{\circ}\text{C}$  unless otherwise noted**T1-T4 IGBT**

Symbol	Description	Value	Unit
$V_{CES}$	Collector-Emitter Voltage	1200	V
$V_{GES}$	Gate-Emitter Voltage	$\pm 20$	V
$I_C$	Collector Current @ $T_C=25^{\circ}\text{C}$	337	A
	@ $T_C=100^{\circ}\text{C}$	200	
$I_{CM}$	Pulsed Collector Current $t_p=1\text{ms}$	400	A
$P_D$	Maximum Power Dissipation @ $T_j=175^{\circ}\text{C}$	1162	W

**D1-D4 Diode**

Symbol	Description	Value	Unit
$V_{RRM}$	Repetitive Peak Reverse Voltage	1200	V
$I_F$	Diode Continuous Forward Current	200	A
$I_{FM}$	Diode Maximum Forward Current $t_p=1\text{ms}$	400	A

**D5,D6 Diode**

Symbol	Description	Value	Unit
$V_{RRM}$	Repetitive Peak Reverse Voltage	1200	V
$I_F$	Diode Continuous Forward Current	200	A
$I_{FM}$	Diode Maximum Forward Current $t_p=1\text{ms}$	400	A

**Module**

Symbol	Description	Value	Unit
$T_{jmax}$	Maximum Junction Temperature	175	$^{\circ}\text{C}$
$T_{jop}$	Operating Junction Temperature	-40 to +150	$^{\circ}\text{C}$
$T_{STG}$	Storage Temperature Range	-40 to +125	$^{\circ}\text{C}$
$V_{ISO}$	Isolation Voltage RMS, $f=50\text{Hz}$ , $t=1\text{min}$	2500	V

**T1-T4 IGBT Characteristics**  $T_C=25^\circ\text{C}$  unless otherwise noted

Symbol	Parameter	Test Conditions	Min.	Typ.	Max.	Unit	
$V_{CE(sat)}$	Collector to Emitter Saturation Voltage	$I_C=200\text{A}, V_{GE}=15\text{V}, T_j=25^\circ\text{C}$		1.70	2.15	V	
		$I_C=200\text{A}, V_{GE}=15\text{V}, T_j=125^\circ\text{C}$		1.95			
		$I_C=200\text{A}, V_{GE}=15\text{V}, T_j=150^\circ\text{C}$		2.00			
$V_{GE(th)}$	Gate-Emitter Threshold Voltage	$I_C=5.0\text{mA}, V_{CE}=V_{GE}, T_j=25^\circ\text{C}$	5.2	6.0	6.8	V	
$I_{CES}$	Collector Cut-Off Current	$V_{CE}=V_{CES}, V_{GE}=0\text{V}, T_j=25^\circ\text{C}$			1.0	mA	
$I_{GES}$	Gate-Emitter Leakage Current	$V_{GE}=V_{GES}, V_{CE}=0\text{V}, T_j=25^\circ\text{C}$			400	nA	
$R_{Gint}$	Internal Gate Resistance			4.0		$\Omega$	
$C_{ies}$	Input Capacitance	$V_{CE}=25\text{V}, f=1\text{MHz}, V_{GE}=0\text{V}$		20.7		nF	
$C_{res}$	Reverse Transfer Capacitance				0.58		nF
$Q_G$	Gate Charge	$V_{GE}=-15\dots+15\text{V}$		1.55		$\mu\text{C}$	
$t_{d(on)}$	Turn-On Delay Time	$V_{CC}=600\text{V}, I_C=200\text{A}, R_G=1.1\Omega, V_{GE}=\pm 15\text{V}, T_j=25^\circ\text{C}$		150		ns	
$t_r$	Rise Time			32		ns	
$t_{d(off)}$	Turn-Off Delay Time			330		ns	
$t_f$	Fall Time			93		ns	
$E_{on}$	Turn-On Switching Loss			11.2		mJ	
$E_{off}$	Turn-Off Switching Loss			11.3		mJ	
$t_{d(on)}$	Turn-On Delay Time		$V_{CC}=600\text{V}, I_C=200\text{A}, R_G=1.1\Omega, V_{GE}=\pm 15\text{V}, T_j=125^\circ\text{C}$		161		ns
$t_r$	Rise Time				37		ns
$t_{d(off)}$	Turn-Off Delay Time			412		ns	
$t_f$	Fall Time			165		ns	
$E_{on}$	Turn-On Switching Loss			19.8		mJ	
$E_{off}$	Turn-Off Switching Loss			17.0		mJ	
$t_{d(on)}$	Turn-On Delay Time	$V_{CC}=600\text{V}, I_C=200\text{A}, R_G=1.1\Omega, V_{GE}=\pm 15\text{V}, T_j=150^\circ\text{C}$			161		ns
$t_r$	Rise Time				43		ns
$t_{d(off)}$	Turn-Off Delay Time			433		ns	
$t_f$	Fall Time			185		ns	
$E_{on}$	Turn-On Switching Loss			21.9		mJ	
$E_{off}$	Turn-Off Switching Loss			19.1		mJ	
$I_{SC}$	SC Data		$t_p \leq 10\mu\text{s}, V_{GE}=15\text{V}, T_j=150^\circ\text{C}, V_{CC}=900\text{V}, V_{CEM} \leq 1200\text{V}$		800		A

**D1-D4 Diode Characteristics**  $T_C=25^\circ\text{C}$  unless otherwise noted

Symbol	Parameter	Test Conditions	Min.	Typ.	Max.	Units
$V_F$	Diode Forward Voltage	$I_F=200\text{A}, V_{GE}=0\text{V}, T_j=25^\circ\text{C}$		1.65	2.10	V
		$I_F=200\text{A}, V_{GE}=0\text{V}, T_j=125^\circ\text{C}$		1.65		
		$I_F=200\text{A}, V_{GE}=0\text{V}, T_j=150^\circ\text{C}$		1.65		
$Q_r$	Recovered Charge	$V_R=600\text{V}, I_F=200\text{A},$ $-di/dt=5400\text{A}/\mu\text{s}, V_{GE}=-15\text{V}$ $T_j=25^\circ\text{C}$		17.6		$\mu\text{C}$
$I_{RM}$	Peak Reverse Recovery Current			228		A
$E_{rec}$	Reverse Recovery Energy			7.7		mJ
$Q_r$	Recovered Charge	$V_R=600\text{V}, I_F=200\text{A},$ $-di/dt=5400\text{A}/\mu\text{s}, V_{GE}=-15\text{V}$ $T_j=125^\circ\text{C}$		31.8		$\mu\text{C}$
$I_{RM}$	Peak Reverse Recovery Current			238		A
$E_{rec}$	Reverse Recovery Energy			13.8		mJ
$Q_r$	Recovered Charge	$V_R=600\text{V}, I_F=200\text{A},$ $-di/dt=5400\text{A}/\mu\text{s}, V_{GE}=-15\text{V}$ $T_j=150^\circ\text{C}$		36.6		$\mu\text{C}$
$I_{RM}$	Peak Reverse Recovery Current			247		A
$E_{rec}$	Reverse Recovery Energy			15.2		mJ

**D5,D6 Diode Characteristics**  $T_C=25^\circ\text{C}$  unless otherwise noted

Symbol	Parameter	Test Conditions	Min.	Typ.	Max.	Units
$V_F$	Diode Forward Voltage	$I_F=200\text{A}, V_{GE}=0\text{V}, T_j=25^\circ\text{C}$		1.65	2.10	V
		$I_F=200\text{A}, V_{GE}=0\text{V}, T_j=125^\circ\text{C}$		1.65		
		$I_F=200\text{A}, V_{GE}=0\text{V}, T_j=150^\circ\text{C}$		1.65		
$Q_r$	Recovered Charge	$V_R=600\text{V}, I_F=200\text{A},$ $-di/dt=5400\text{A}/\mu\text{s}, V_{GE}=-15\text{V}$ $T_j=25^\circ\text{C}$		17.6		$\mu\text{C}$
$I_{RM}$	Peak Reverse Recovery Current			228		A
$E_{rec}$	Reverse Recovery Energy			7.7		mJ
$Q_r$	Recovered Charge	$V_R=600\text{V}, I_F=200\text{A},$ $-di/dt=5400\text{A}/\mu\text{s}, V_{GE}=-15\text{V}$ $T_j=125^\circ\text{C}$		31.8		$\mu\text{C}$
$I_{RM}$	Peak Reverse Recovery Current			238		A
$E_{rec}$	Reverse Recovery Energy			13.8		mJ
$Q_r$	Recovered Charge	$V_R=600\text{V}, I_F=200\text{A},$ $-di/dt=5400\text{A}/\mu\text{s}, V_{GE}=-15\text{V}$ $T_j=150^\circ\text{C}$		36.6		$\mu\text{C}$
$I_{RM}$	Peak Reverse Recovery Current			247		A
$E_{rec}$	Reverse Recovery Energy			15.2		mJ

**NTC Characteristics**  $T_C=25^{\circ}\text{C}$  unless otherwise noted

Symbol	Parameter	Test Conditions	Min.	Typ.	Max.	Unit
$R_{25}$	Rated Resistance			5.0		$\text{k}\Omega$
$\Delta R/R$	Deviation of $R_{100}$	$T_C=100^{\circ}\text{C}, R_{100}=493.3\Omega$	-5		5	%
$P_{25}$	Power Dissipation				20.0	mW
$B_{25/50}$	B-value	$R_2=R_{25}\exp[B_{25/50}(1/T_2-1/(298.15\text{K}))]$		3375		K
$B_{25/80}$	B-value	$R_2=R_{25}\exp[B_{25/80}(1/T_2-1/(298.15\text{K}))]$		3411		K
$B_{25/100}$	B-value	$R_2=R_{25}\exp[B_{25/100}(1/T_2-1/(298.15\text{K}))]$		3433		K

**Module Characteristics**  $T_C=25^{\circ}\text{C}$  unless otherwise noted

Symbol	Parameter	Min.	Typ.	Max.	Unit
$R_{thJC}$	Junction-to-Case (per T1-T4 IGBT)			0.129	K/W
	Junction-to-Case (per D1-D4 Diode)			0.237	
	Junction-to-Case (per D5,D6 Diode)			0.232	
$R_{thCH}$	Case-to-Heatsink (per T1-T4 IGBT)		0.073		K/W
	Case-to-Heatsink (per D1-D4 Diode)		0.134		
	Case-to-Heatsink (per D5,D6 Diode)		0.131		
	Case-to-Heatsink (per Module)		0.010		
M	Terminal Connection Torque, Screw M6	2.5		5.0	
	Mounting Torque, Screw M6	3.0		5.0	
G	Weight of Module		340		g

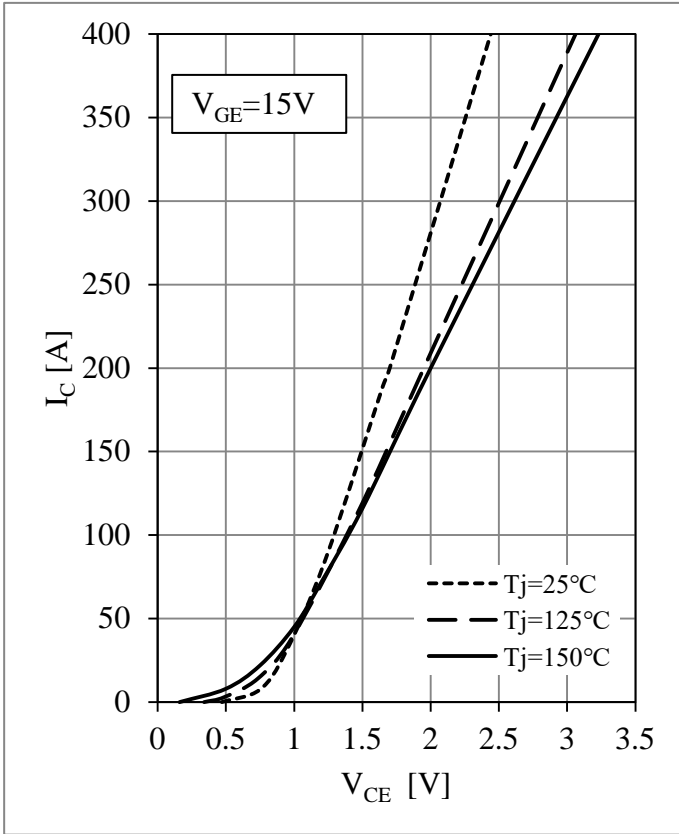

Fig 1. T1-T4 IGBT Output Characteristics

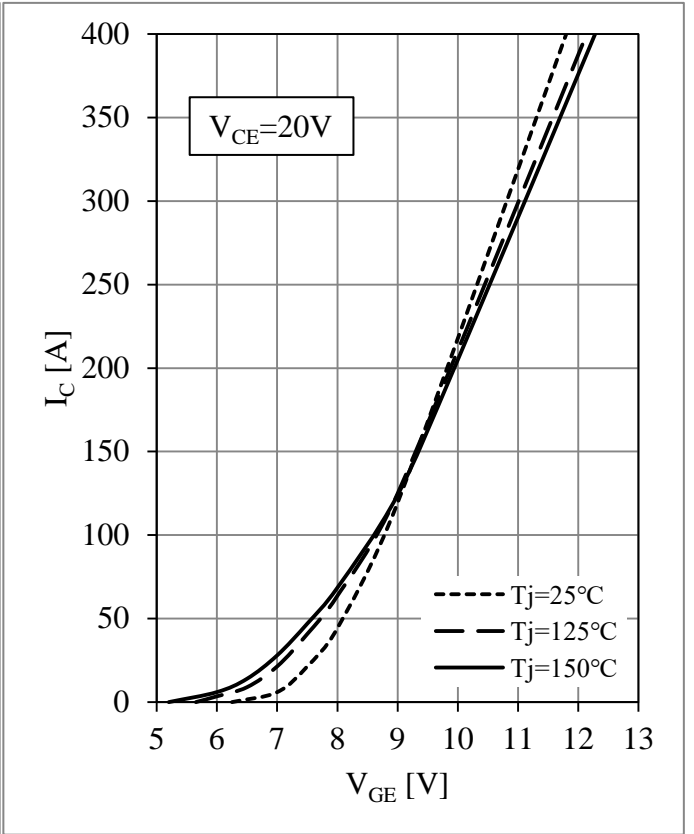

Fig 2. T1-T4 IGBT Transfer Characteristics

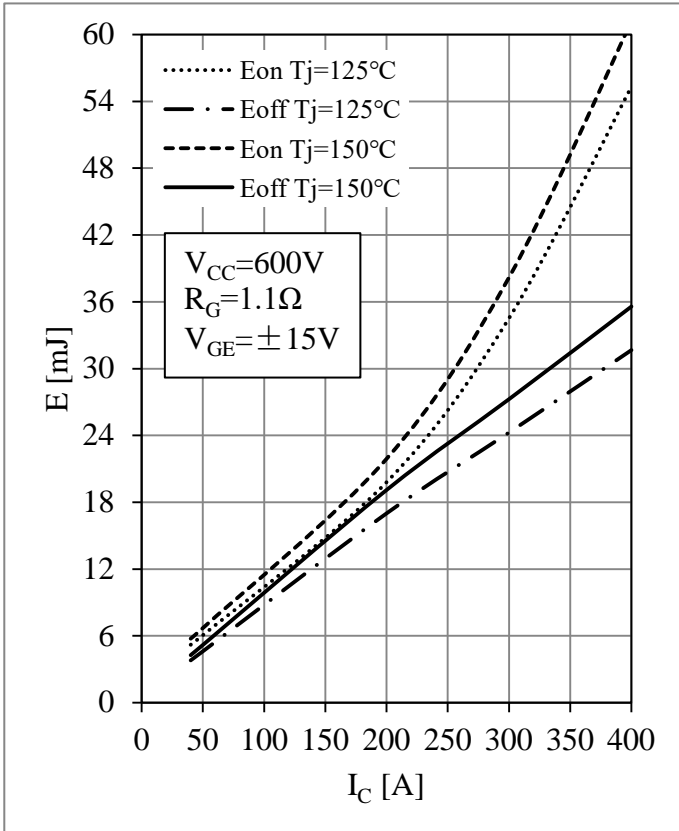

Fig 3. T1-T4 IGBT Switching Loss vs.  $I_C$

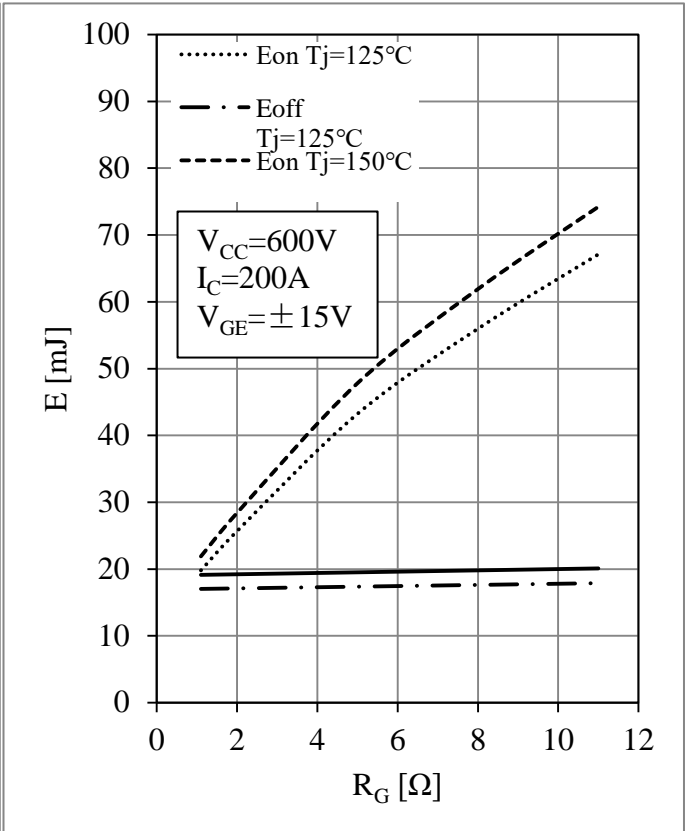

Fig 4. T1-T4 IGBT Switching Loss vs.  $R_G$

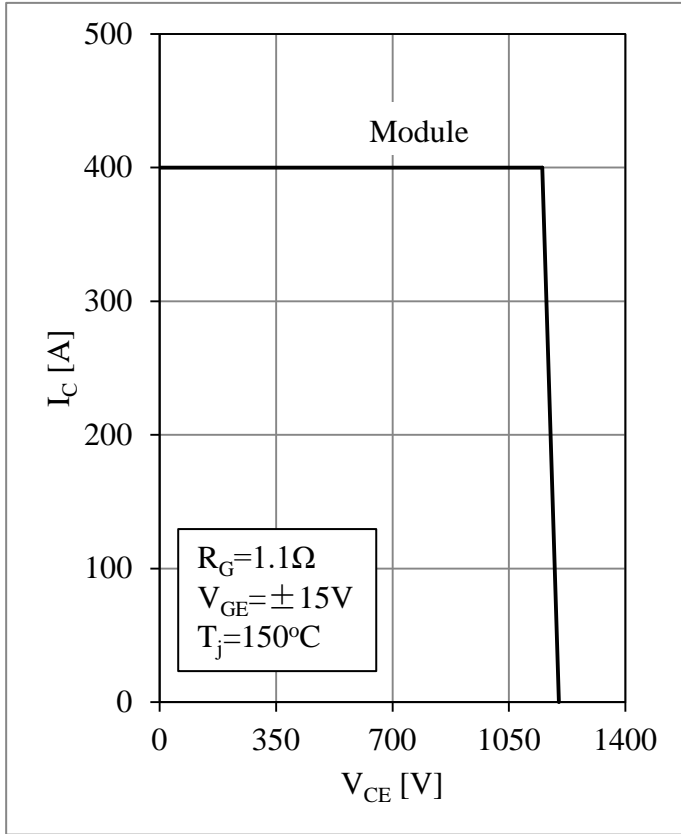

Fig 5. T1-T4 RBSOA

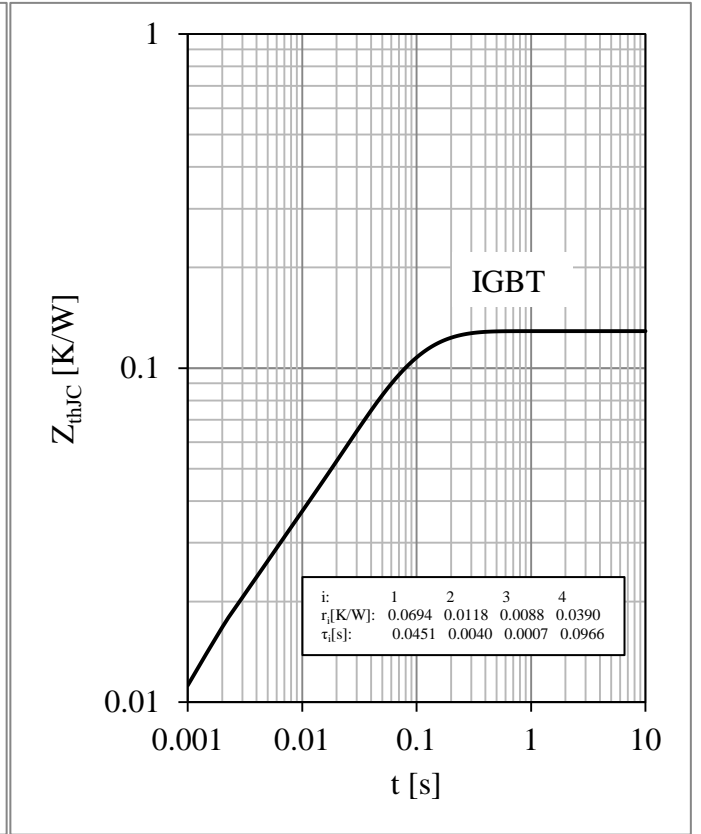

Fig 6. T1-T4 IGBT Transient Thermal Impedance

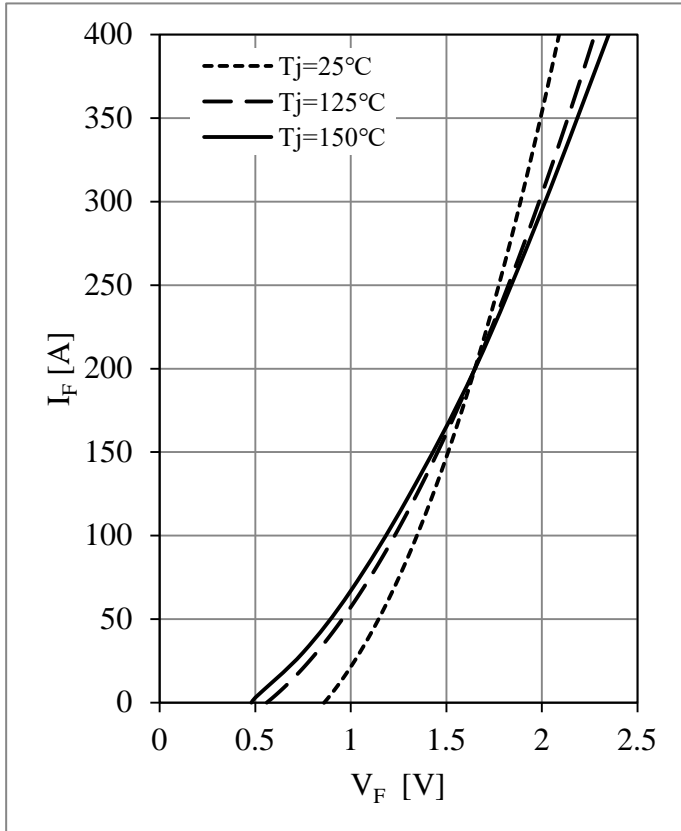

Fig 7. D1-D4 Diode Forward Characteristics

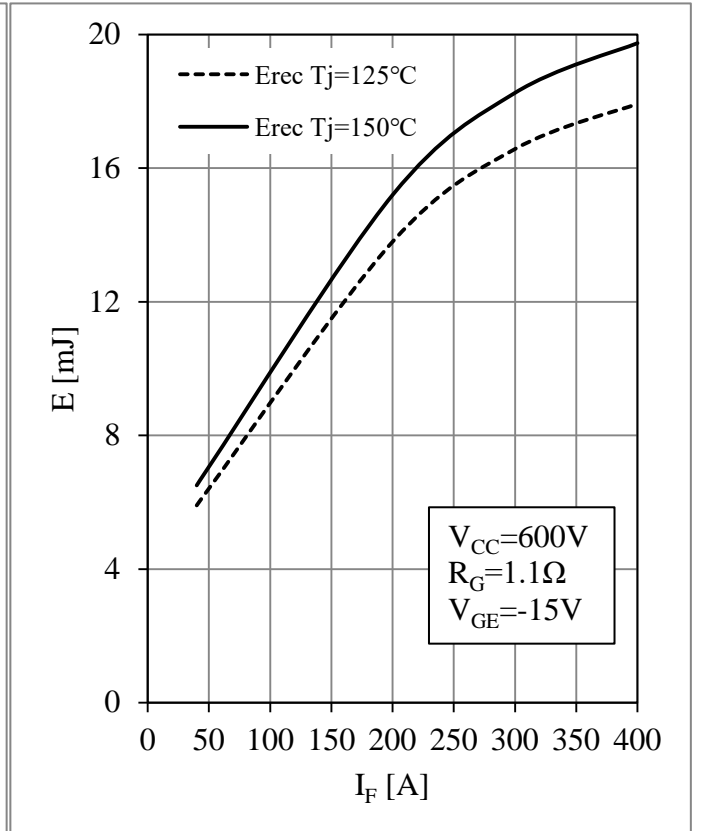

Fig 8. D1-D4 Diode Switching Loss vs.  $I_F$

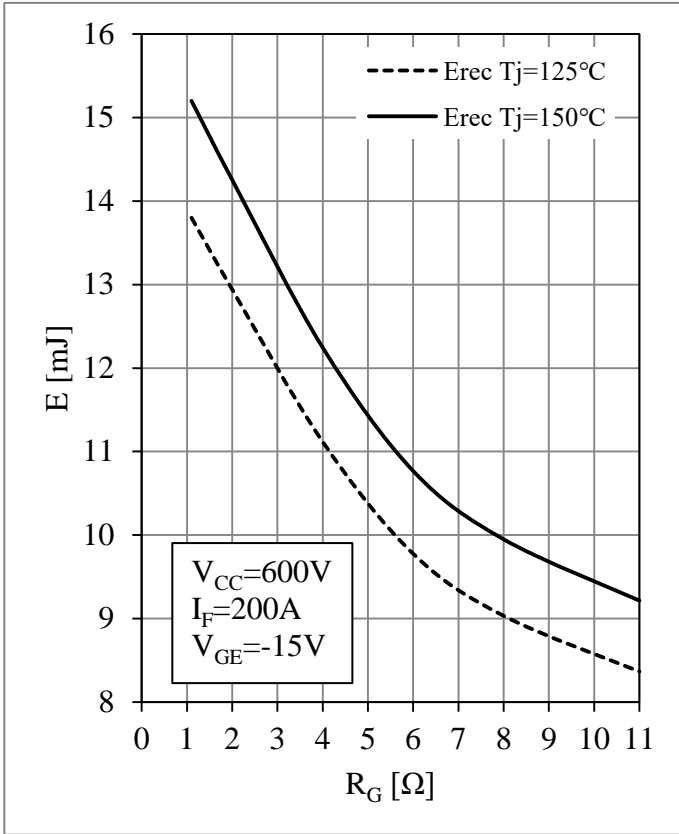

Fig 9. D1-D4 Diode Switching Loss vs.  $R_G$

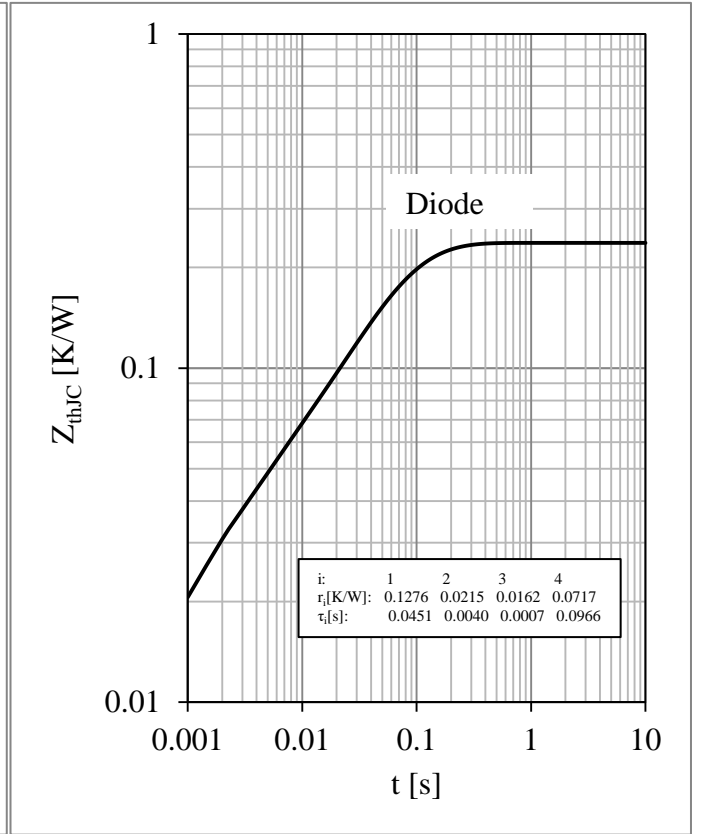

Fig 10. D1-D4 Diode Transient Thermal Impedance

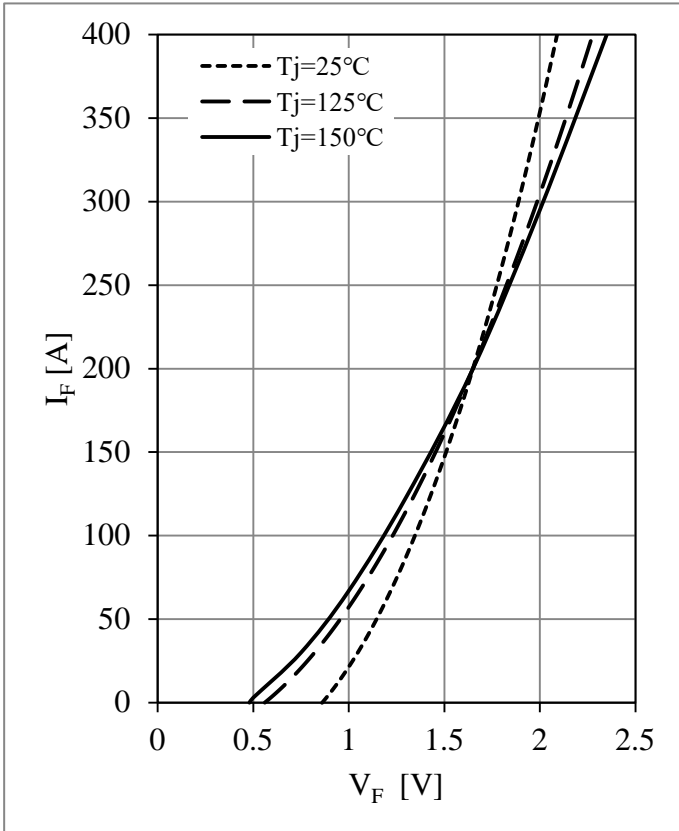

Fig 11. D5,D6 Diode Forward Characteristics

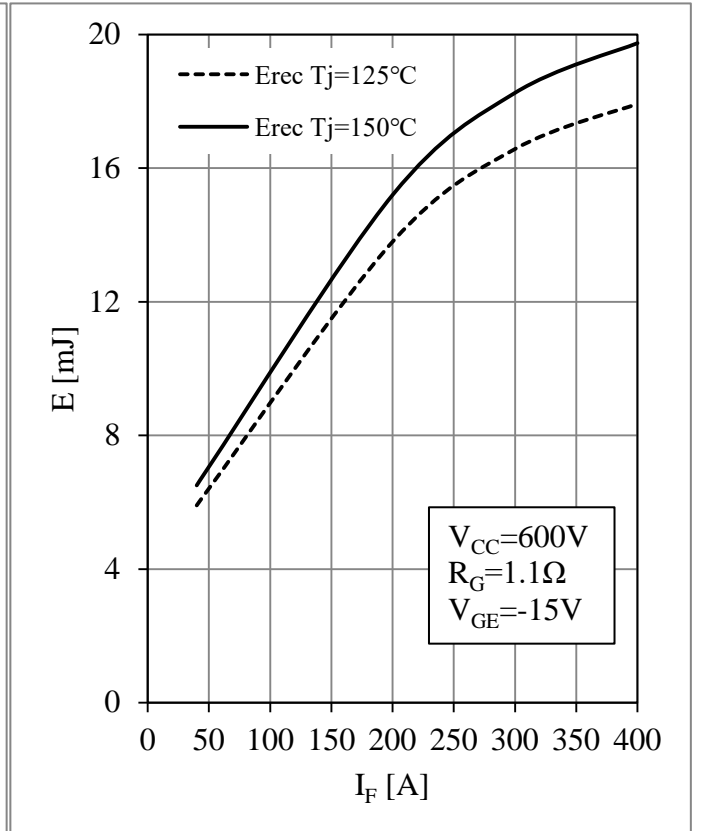

Fig 12. D5,D6 Diode Switching Loss vs.  $I_F$



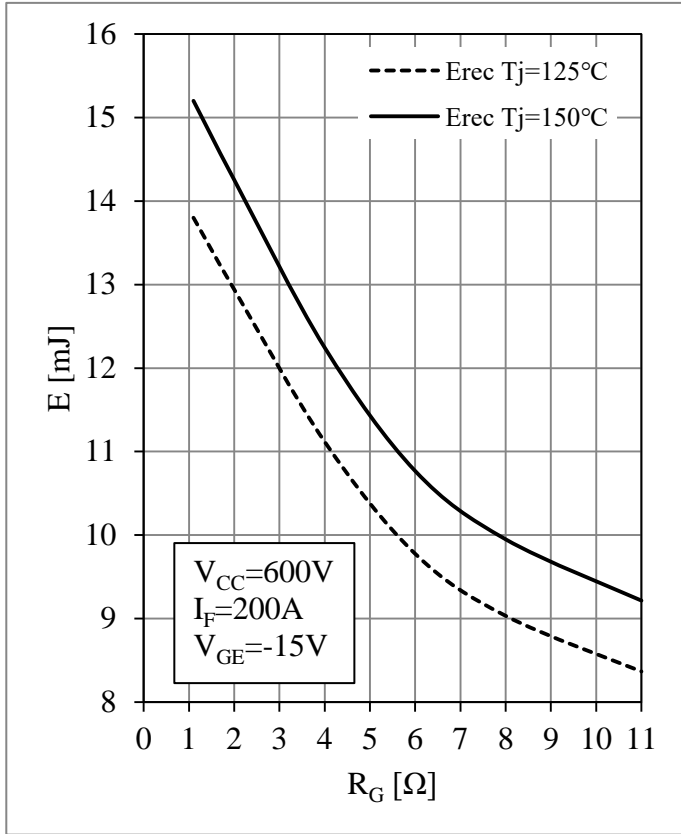

Fig 13. D5,D6 Diode Switching Loss vs.  $R_G$

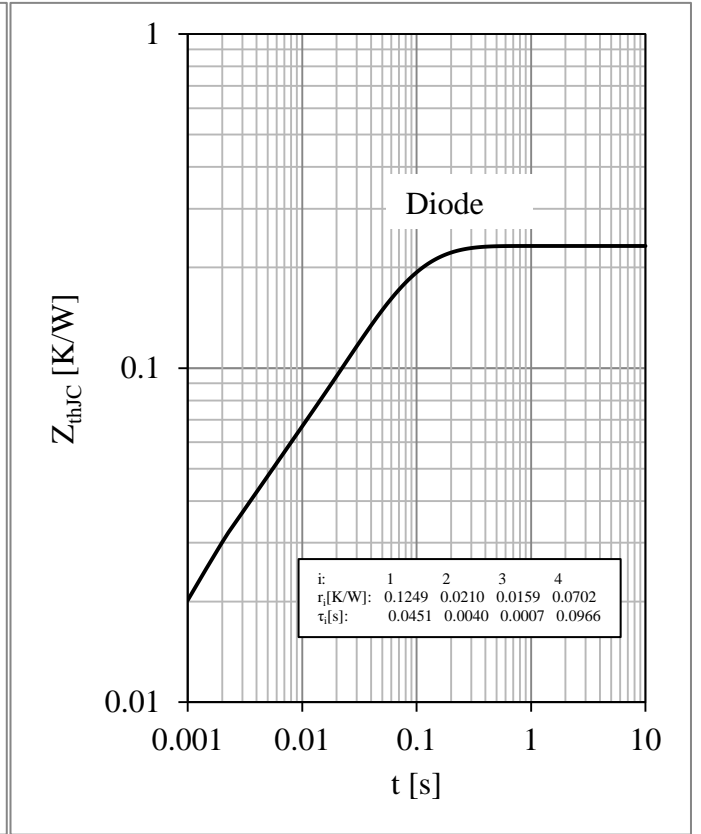

Fig 14. D5,D6 Diode Transient Thermal Impedance

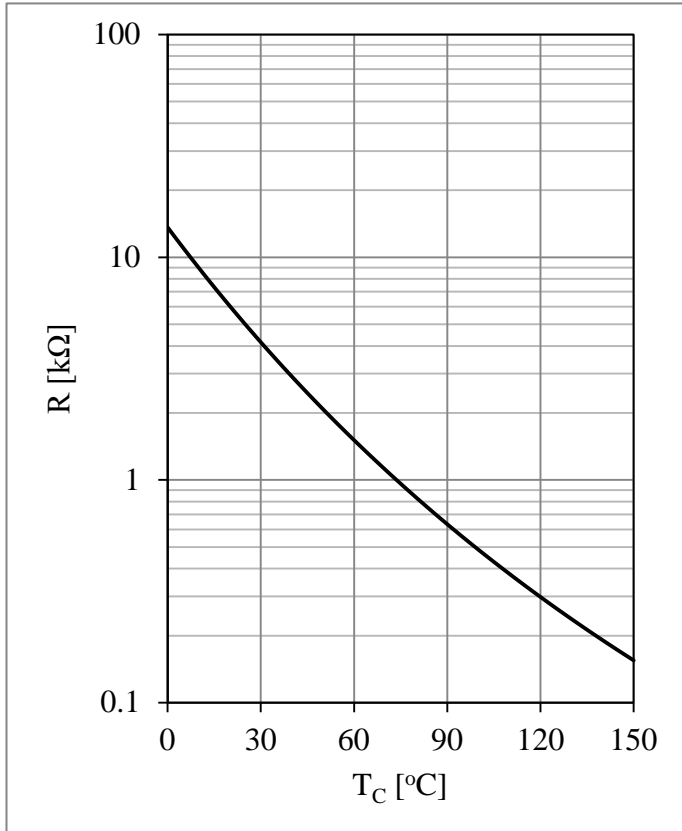
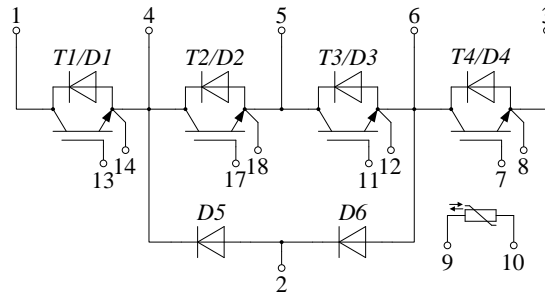

Fig 15. NTC Temperature Characteristic

**Circuit Schematic**



**Package Dimensions**

Dimensions in Millimeters

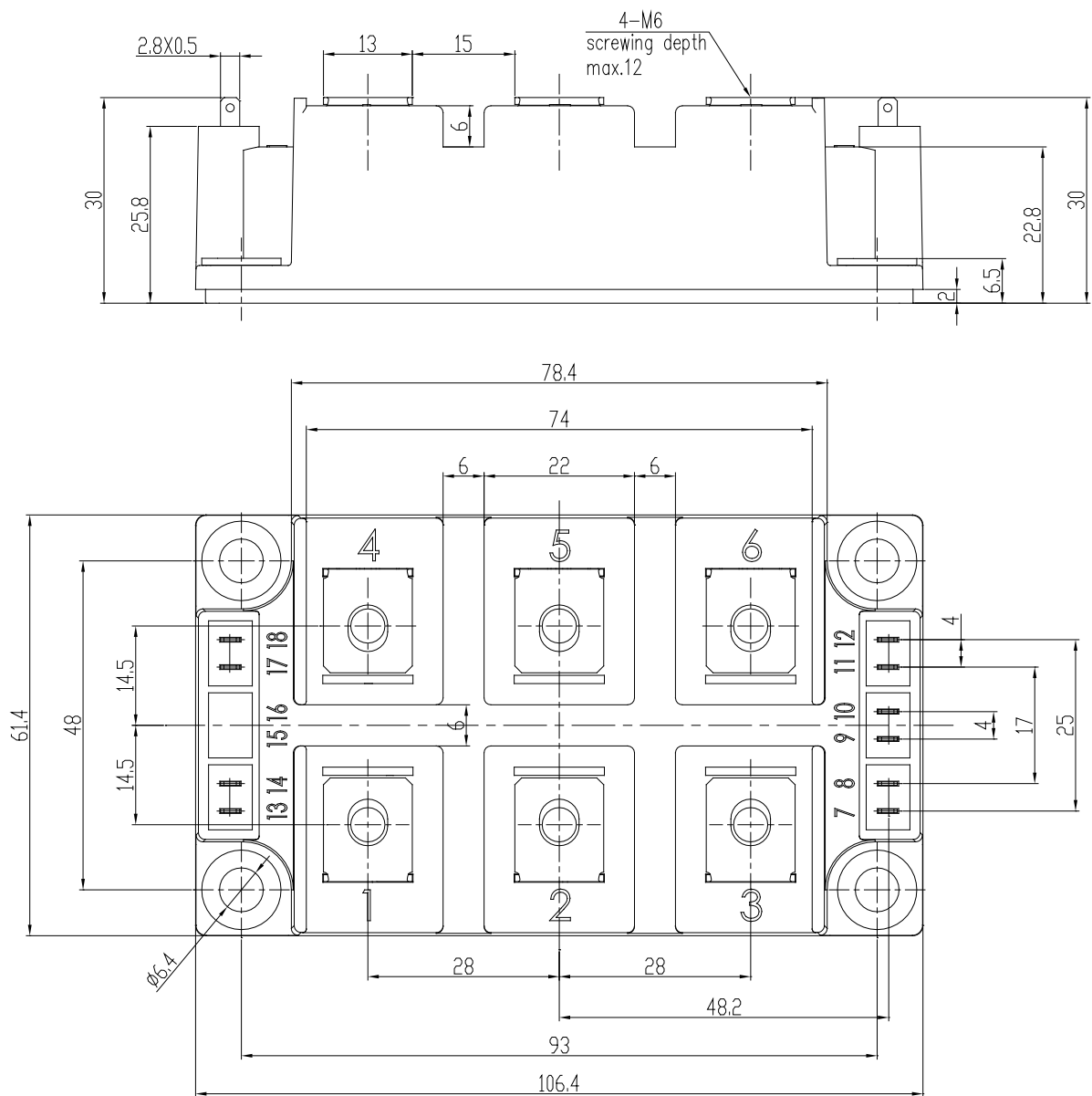

## Terms and Conditions of Usage

The data contained in this product datasheet is exclusively intended for technically trained staff. you and your technical departments will have to evaluate the suitability of the product for the intended application and the completeness of the product data with respect to such application.

This product data sheet is describing the characteristics of this product for which a warranty is granted. Any such warranty is granted exclusively pursuant the terms and conditions of the supply agreement. There will be no guarantee of any kind for the product and its characteristics.

Should you require product information in excess of the data given in this product data sheet or which concerns the specific application of our product, please contact the sales office, which is responsible for you (see [www.powersemi.cc](http://www.powersemi.cc)), For those that are specifically interested we may provide application notes.

Due to technical requirements our product may contain dangerous substances. For information on the types in question please contact the sales office, which is responsible for you.

Should you intend to use the Product in aviation applications, in health or live endangering or life support applications, please notify.

If and to the extent necessary, please forward equivalent notices to your customers.  
Changes of this product data sheet are reserved.