

# STARPOWER

SEMICONDUCTOR

**IGBT**

## GD150MLX65C2S

**650V/150A in one-package**

### General Description

STARPOWER IGBT Power Module provides ultra low conduction loss as well as short circuit ruggedness. They are designed for the applications such as 3-level-applications.

### Features

- Low  $V_{CE(sat)}$  trench IGBT technology
- 6 $\mu$ s short circuit capability
- $V_{CE(sat)}$  with positive temperature coefficient
- Maximum junction temperature 175°C
- Low inductance case
- Fast & soft reverse recovery anti-parallel FWD
- Isolated copper baseplate using DBC technology

### Typical Applications

- Solar power
- UPS
- 3-level-applications

### Equivalent Circuit Schematic

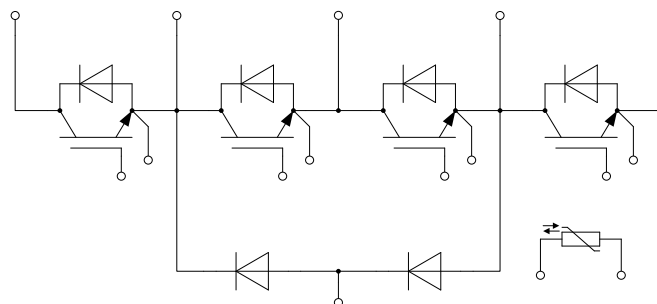

**Absolute Maximum Ratings**  $T_C=25^{\circ}\text{C}$  unless otherwise noted**T1-T4 IGBT**

Symbol	Description	Value	Unit
$V_{CES}$	Collector-Emitter Voltage	650	V
$V_{GES}$	Gate-Emitter Voltage	$\pm 20$	V
$I_C$	Collector Current @ $T_C=25^{\circ}\text{C}$	181	A
	@ $T_C=60^{\circ}\text{C}$	150	A
$I_{CM}$	Pulsed Collector Current $t_p=1\text{ms}$	300	A
$P_D$	Maximum Power Dissipation @ $T_j=175^{\circ}\text{C}$	442	W

**D1-D4 Diode**

Symbol	Description	Value	Unit
$V_{RRM}$	Repetitive Peak Reverse Voltage	650	V
$I_F$	Diode Continuous Forward Current	150	A
$I_{FM}$	Diode Maximum Forward Current $t_p=1\text{ms}$	300	A

**D5,D6 Diode**

Symbol	Description	Value	Unit
$V_{RRM}$	Repetitive Peak Reverse Voltage	650	V
$I_F$	Diode Continuous Forward Current	150	A
$I_{FM}$	Diode Maximum Forward Current $t_p=1\text{ms}$	300	A

**Module**

Symbol	Description	Value	Unit
$T_{jmax}$	Maximum Junction Temperature	175	$^{\circ}\text{C}$
$T_{jop}$	Operating Junction Temperature	-40 to +150	$^{\circ}\text{C}$
$T_{STG}$	Storage Temperature Range	-40 to +125	$^{\circ}\text{C}$
$V_{ISO}$	Isolation Voltage RMS, $f=50\text{Hz}$ , $t=1\text{min}$	4000	V

**T1-T4 IGBT Characteristics**  $T_C=25^\circ\text{C}$  unless otherwise noted

Symbol	Parameter	Test Conditions	Min.	Typ.	Max.	Unit
$V_{CE(sat)}$	Collector to Emitter Saturation Voltage	$I_C=150\text{A}, V_{GE}=15\text{V}, T_j=25^\circ\text{C}$		1.45	1.90	V
		$I_C=150\text{A}, V_{GE}=15\text{V}, T_j=125^\circ\text{C}$		1.60		
		$I_C=150\text{A}, V_{GE}=15\text{V}, T_j=150^\circ\text{C}$		1.70		
$V_{GE(th)}$	Gate-Emitter Threshold Voltage	$I_C=2.40\text{mA}, V_{CE}=V_{GE}, T_j=25^\circ\text{C}$	5.1	5.8	6.5	V
$I_{CES}$	Collector Cut-Off Current	$V_{CE}=V_{CES}, V_{GE}=0\text{V}, T_j=25^\circ\text{C}$			1.0	mA
$I_{GES}$	Gate-Emitter Leakage Current	$V_{GE}=V_{GES}, V_{CE}=0\text{V}, T_j=25^\circ\text{C}$			400	nA
$R_{Gint}$	Internal Gate Resistance			2.0		$\Omega$
$C_{ies}$	Input Capacitance	$V_{CE}=25\text{V}, f=1\text{MHz}, V_{GE}=0\text{V}$		17.4		nF
$C_{res}$	Reverse Transfer Capacitance			0.34		nF
$Q_G$	Gate Charge	$V_{GE}=-15\dots+15\text{V}$		1.04		$\mu\text{C}$
$t_{d(on)}$	Turn-On Delay Time	$V_{CC}=300\text{V}, I_C=150\text{A}, R_G=3.3\Omega, V_{GE}=\pm 15\text{V}, T_j=25^\circ\text{C}$		68		ns
$t_r$	Rise Time			32		ns
$t_{d(off)}$	Turn-Off Delay Time			240		ns
$t_f$	Fall Time			72		ns
$E_{on}$	Turn-On Switching Loss			0.96		mJ
$E_{off}$	Turn-Off Switching Loss			3.32		mJ
$t_{d(on)}$	Turn-On Delay Time	$V_{CC}=300\text{V}, I_C=150\text{A}, R_G=3.3\Omega, V_{GE}=\pm 15\text{V}, T_j=125^\circ\text{C}$		80		ns
$t_r$	Rise Time			36		ns
$t_{d(off)}$	Turn-Off Delay Time			264		ns
$t_f$	Fall Time			104		ns
$E_{on}$	Turn-On Switching Loss			1.40		mJ
$E_{off}$	Turn-Off Switching Loss			4.08		mJ
$t_{d(on)}$	Turn-On Delay Time	$V_{CC}=300\text{V}, I_C=150\text{A}, R_G=3.3\Omega, V_{GE}=\pm 15\text{V}, T_j=150^\circ\text{C}$		88		ns
$t_r$	Rise Time			36		ns
$t_{d(off)}$	Turn-Off Delay Time			272		ns
$t_f$	Fall Time			112		ns
$E_{on}$	Turn-On Switching Loss			1.56		mJ
$E_{off}$	Turn-Off Switching Loss			4.32		mJ
$I_{SC}$	SC Data	$t_p \leq 6\mu\text{s}, V_{GE}=15\text{V}, T_j=150^\circ\text{C}, V_{CC}=360\text{V}, V_{CEM} \leq 650\text{V}$		750		A

**D1-D4 Diode Characteristics**  $T_C=25^\circ\text{C}$  unless otherwise noted

Symbol	Parameter	Test Conditions	Min.	Typ.	Max.	Unit
$V_F$	Diode Forward Voltage	$I_F=150\text{A}, V_{GE}=0\text{V}, T_j=25^\circ\text{C}$		1.55	2.00	V
		$I_F=150\text{A}, V_{GE}=0\text{V}, T_j=125^\circ\text{C}$		1.50		
		$I_F=150\text{A}, V_{GE}=0\text{V}, T_j=150^\circ\text{C}$		1.45		
$Q_r$	Recovered Charge	$V_R=300\text{V}, I_F=150\text{A},$ $-di/dt=2640\text{A}/\mu\text{s}, V_{GE}=-15\text{V}$ $T_j=25^\circ\text{C}$		7.59		$\mu\text{C}$
$I_{RM}$	Peak Reverse Recovery Current			88		A
$E_{rec}$	Reverse Recovery Energy			1.54		mJ
$Q_r$	Recovered Charge	$V_R=300\text{V}, I_F=150\text{A},$ $-di/dt=2640\text{A}/\mu\text{s}, V_{GE}=-15\text{V}$ $T_j=125^\circ\text{C}$		12.7		$\mu\text{C}$
$I_{RM}$	Peak Reverse Recovery Current			116		A
$E_{rec}$	Reverse Recovery Energy			2.75		mJ
$Q_r$	Recovered Charge	$V_R=300\text{V}, I_F=150\text{A},$ $-di/dt=2640\text{A}/\mu\text{s}, V_{GE}=-15\text{V}$ $T_j=150^\circ\text{C}$		14.9		$\mu\text{C}$
$I_{RM}$	Peak Reverse Recovery Current			121		A
$E_{rec}$	Reverse Recovery Energy			3.30		mJ

**D5,D6 Diode Characteristics**  $T_C=25^\circ\text{C}$  unless otherwise noted

Symbol	Parameter	Test Conditions	Min.	Typ.	Max.	Unit
$V_F$	Diode Forward Voltage	$I_F=150\text{A}, V_{GE}=0\text{V}, T_j=25^\circ\text{C}$		1.55	2.00	V
		$I_F=150\text{A}, V_{GE}=0\text{V}, T_j=125^\circ\text{C}$		1.50		
		$I_F=150\text{A}, V_{GE}=0\text{V}, T_j=150^\circ\text{C}$		1.45		
$Q_r$	Recovered Charge	$V_R=300\text{V}, I_F=150\text{A},$ $-di/dt=2640\text{A}/\mu\text{s}, V_{GE}=-15\text{V}$ $T_j=25^\circ\text{C}$		7.59		$\mu\text{C}$
$I_{RM}$	Peak Reverse Recovery Current			88		A
$E_{rec}$	Reverse Recovery Energy			1.54		mJ
$Q_r$	Recovered Charge	$V_R=300\text{V}, I_F=150\text{A},$ $-di/dt=2640\text{A}/\mu\text{s}, V_{GE}=-15\text{V}$ $T_j=125^\circ\text{C}$		12.7		$\mu\text{C}$
$I_{RM}$	Peak Reverse Recovery Current			116		A
$E_{rec}$	Reverse Recovery Energy			2.75		mJ
$Q_r$	Recovered Charge	$V_R=300\text{V}, I_F=150\text{A},$ $-di/dt=2640\text{A}/\mu\text{s}, V_{GE}=-15\text{V}$ $T_j=150^\circ\text{C}$		14.9		$\mu\text{C}$
$I_{RM}$	Peak Reverse Recovery Current			121		A
$E_{rec}$	Reverse Recovery Energy			3.30		mJ

**NTC Characteristics**  $T_C=25^{\circ}\text{C}$  unless otherwise noted

Symbol	Parameter	Test Conditions	Min.	Typ.	Max.	Unit
$R_{25}$	Rated Resistance			5.0		$\text{k}\Omega$
$\Delta R/R$	Deviation of $R_{100}$	$T_C=100^{\circ}\text{C}, R_{100}=493.3\Omega$	-5		5	%
$P_{25}$	Power Dissipation				20.0	mW
$B_{25/50}$	B-value	$R_2=R_{25}\exp[B_{25/50}(1/T_2-1/(298.15\text{K}))]$		3375		K
$B_{25/80}$	B-value	$R_2=R_{25}\exp[B_{25/80}(1/T_2-1/(298.15\text{K}))]$		3411		K
$B_{25/100}$	B-value	$R_2=R_{25}\exp[B_{25/100}(1/T_2-1/(298.15\text{K}))]$		3433		K

**Module Characteristics**  $T_C=25^{\circ}\text{C}$  unless otherwise noted

Symbol	Parameter	Min.	Typ.	Max.	Unit
$R_{thJC}$	Junction-to-Case (per T1-T4 IGBT)			0.339	K/W
	Junction-to-Case (per D1-D4 Diode)			0.551	
	Junction-to-Case (per D5,D6 Diode)			0.551	
$R_{thCH}$	Case-to-Heatsink (per T1-T4 IGBT)		0.077		K/W
	Case-to-Heatsink (per D1-D4 Diode)		0.125		
	Case-to-Heatsink (per D5,D6 Diode)		0.125		
	Case-to-Heatsink (per Module)		0.010		
M	Terminal Connection Torque, Screw M6	2.5		5.0	N.m
	Mounting Torque, Screw M6	3.0		5.0	
G	Weight of Module		340		g

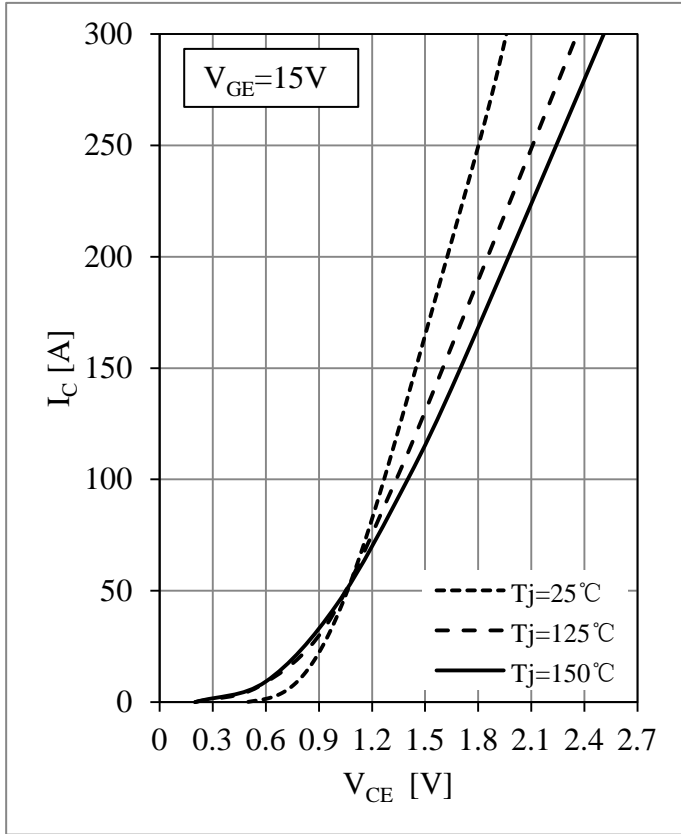

Fig 1. T1-T4 IGBT Output Characteristics

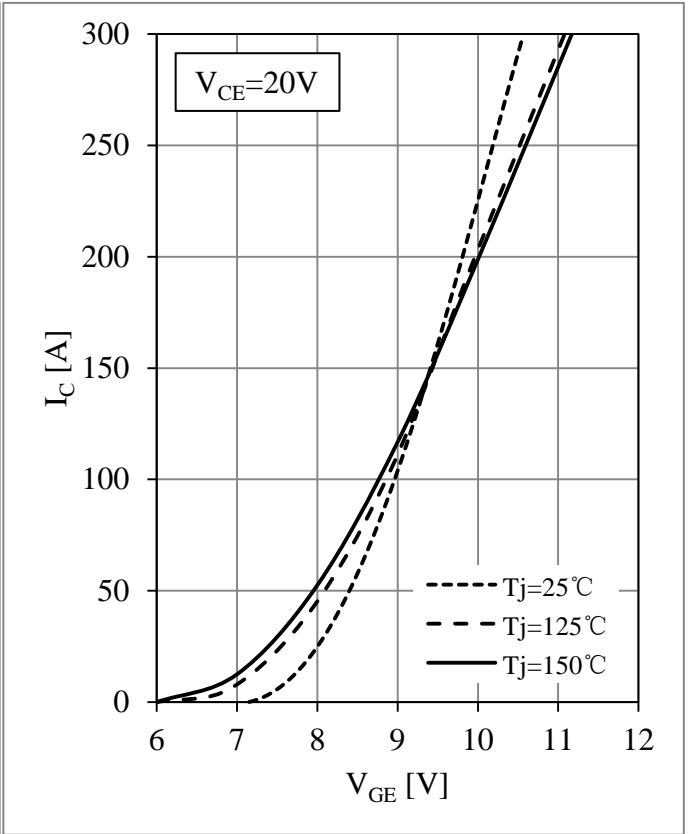

Fig 2. T1-T4 IGBT Transfer Characteristics

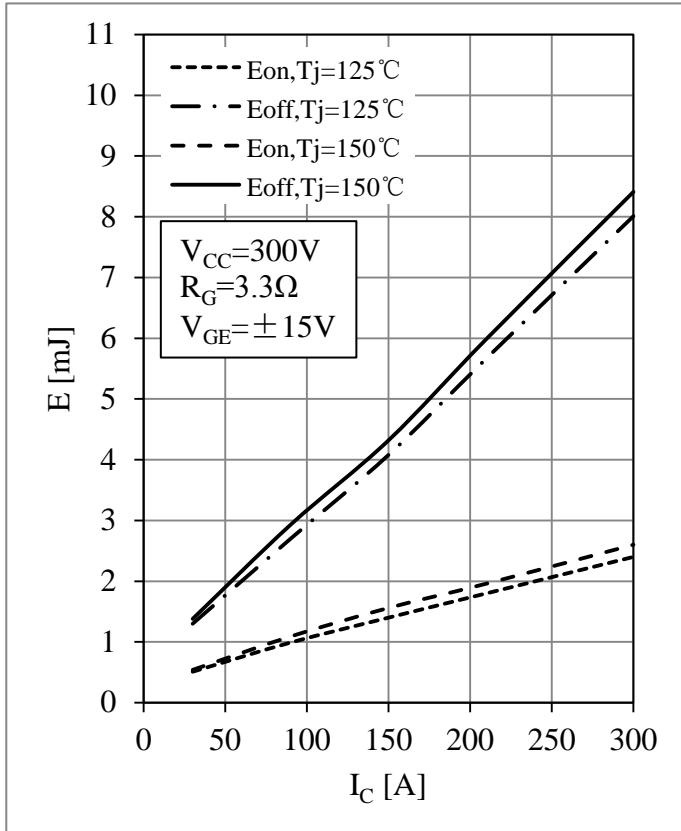

Fig 3. T1-T4 IGBT Switching Loss vs.  $I_C$

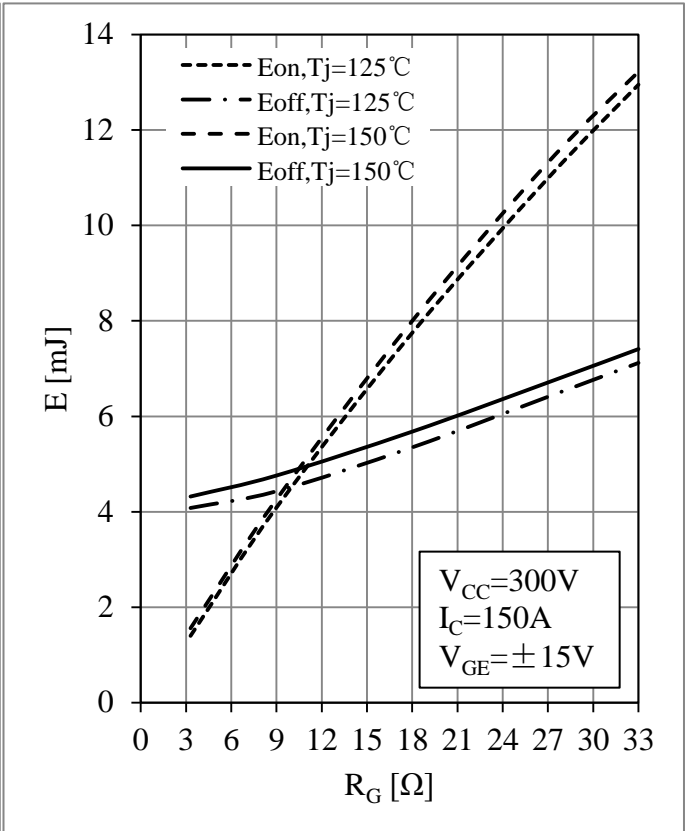

Fig 4. T1-T4 IGBT Switching Loss vs.  $R_G$

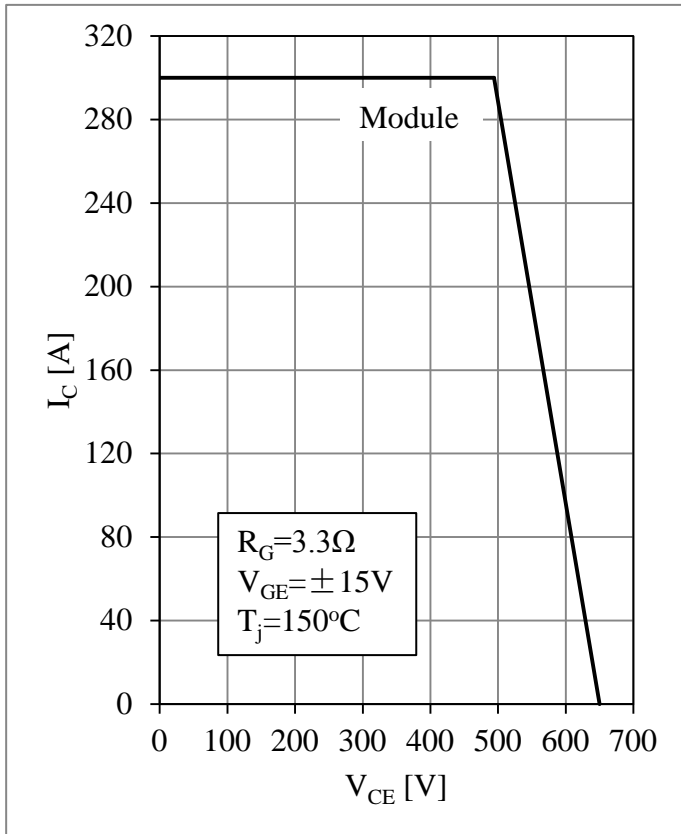

Fig 5. T1-T4 RBSOA

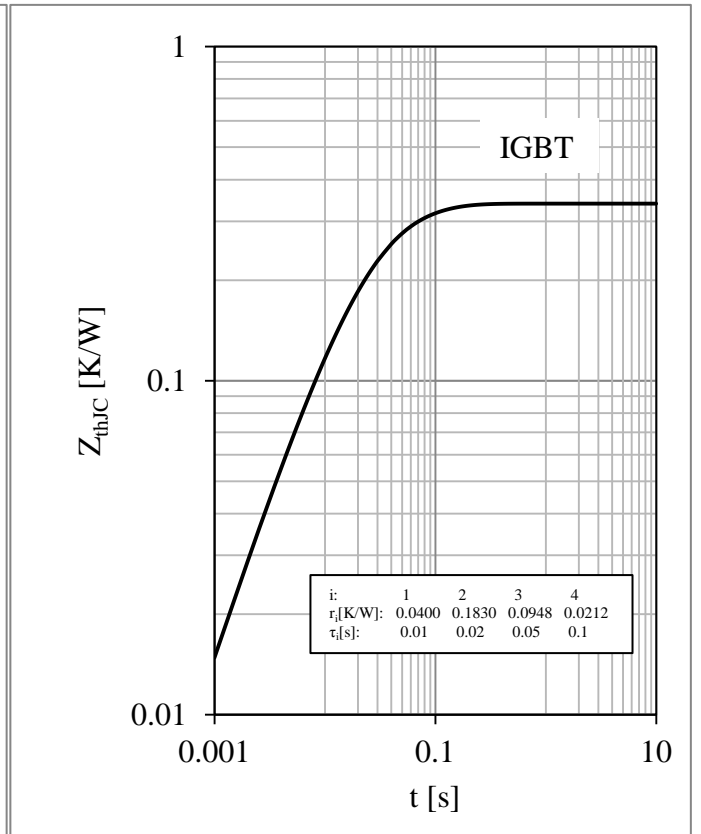

Fig 6. T1-T4 IGBT Transient Thermal Impedance

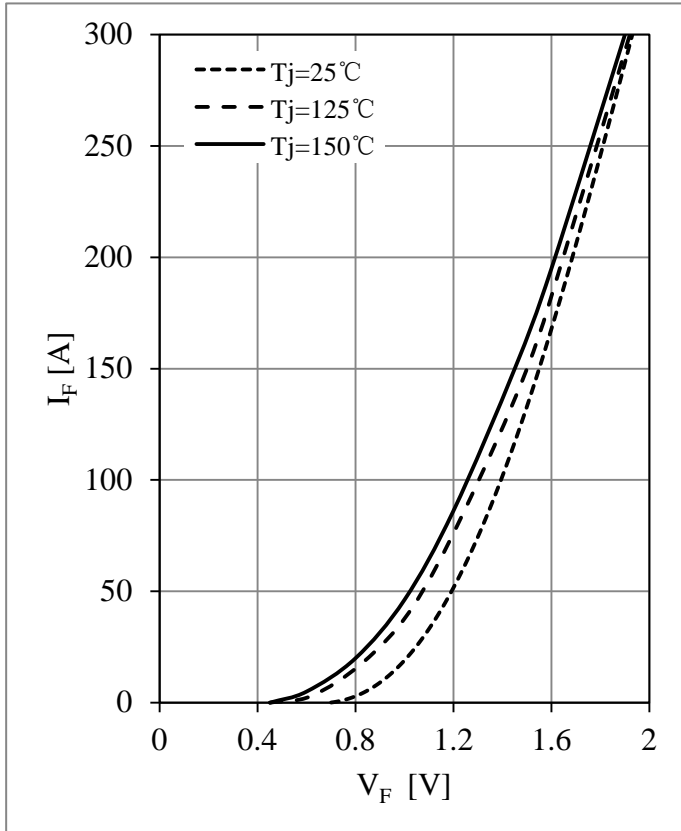

Fig 7. D1-D4 Diode Forward Characteristics

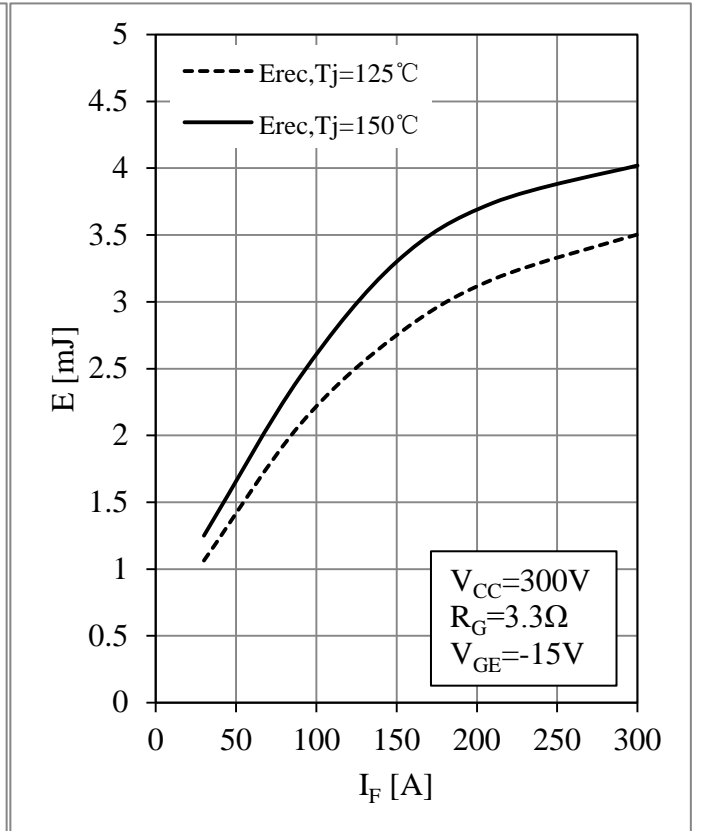

Fig 8. D1-D4 Diode Switching Loss vs.  $I_F$

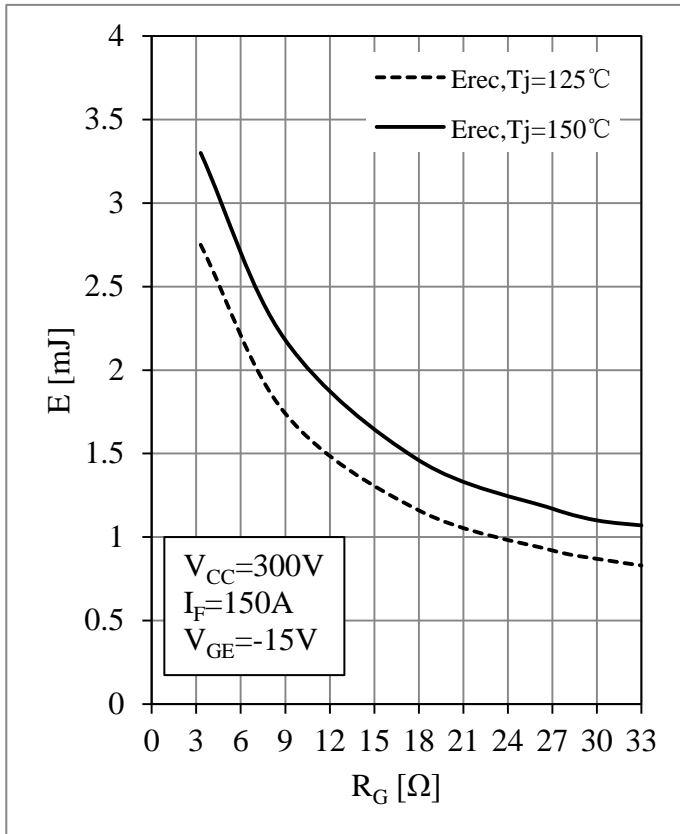

Fig 9. D1-D4 Diode Switching Loss vs.  $R_G$

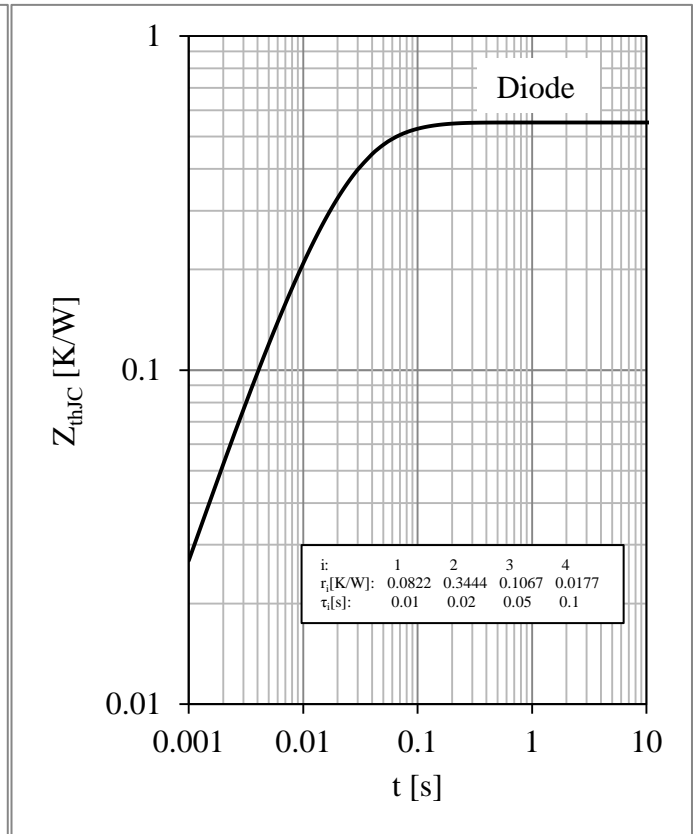

Fig 10. D1-D4 Diode Transient Thermal Impedance

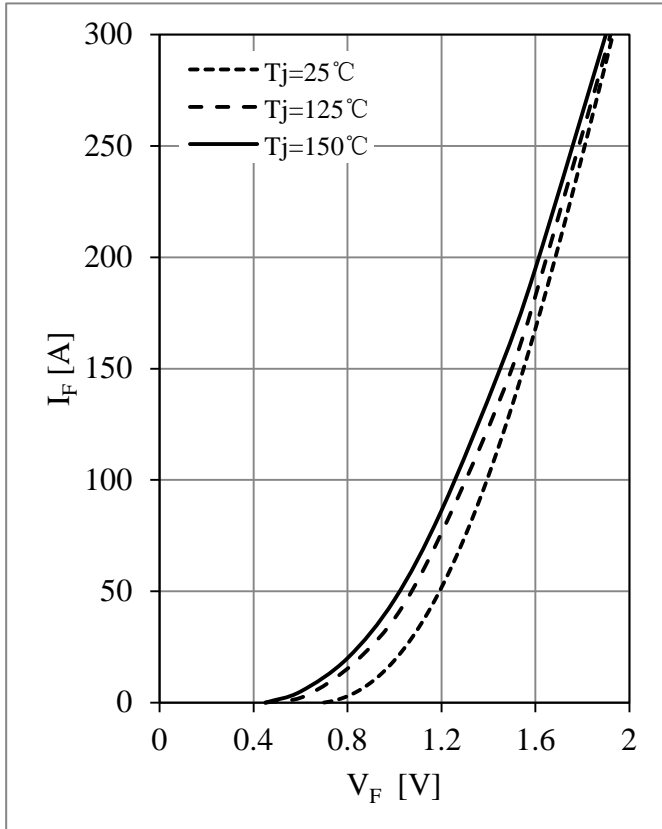

Fig 11. D5,D6 Diode Forward Characteristics

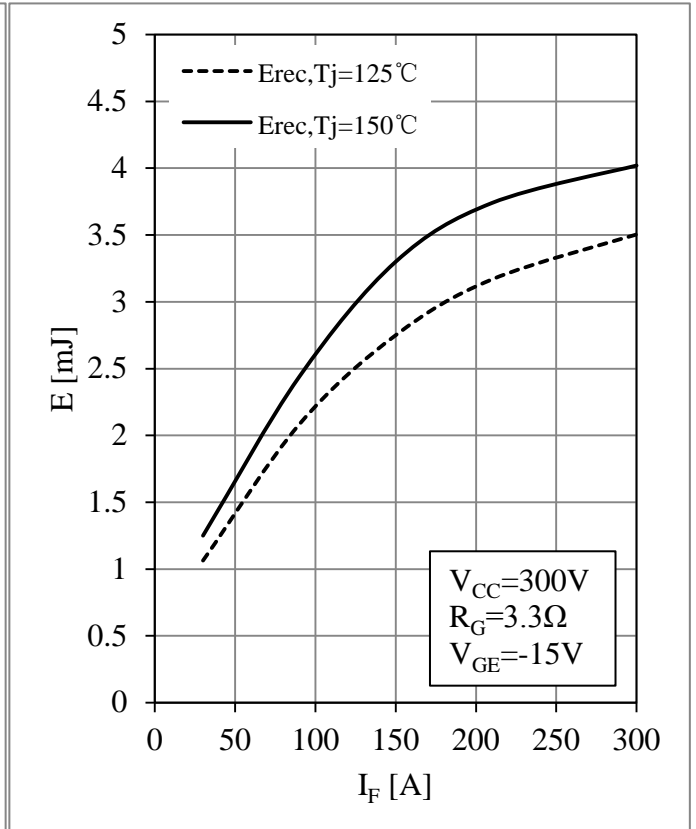

Fig 12. D5,D6 Diode Switching Loss vs.  $I_F$



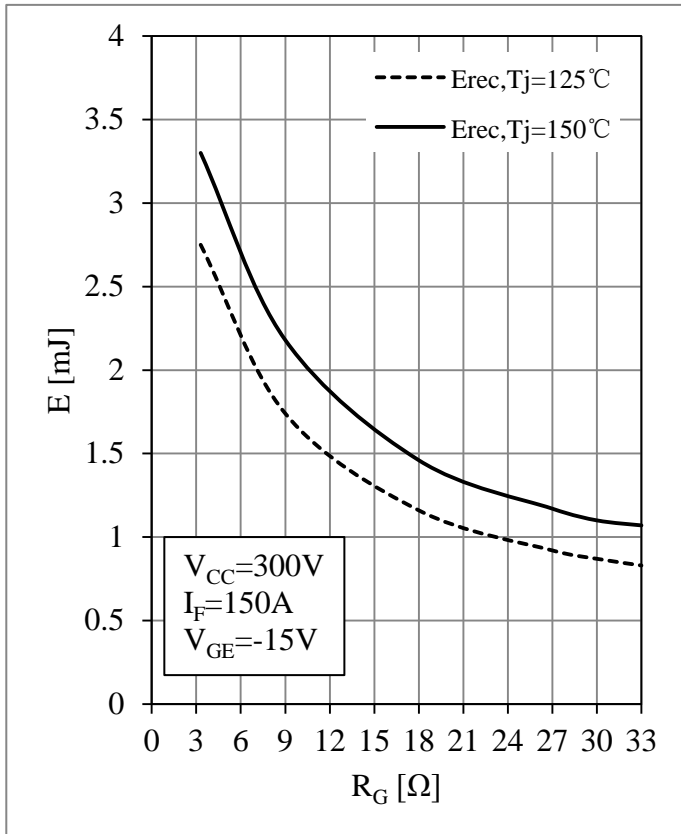

Fig 13. D5,D6 Diode Switching Loss vs.  $R_G$

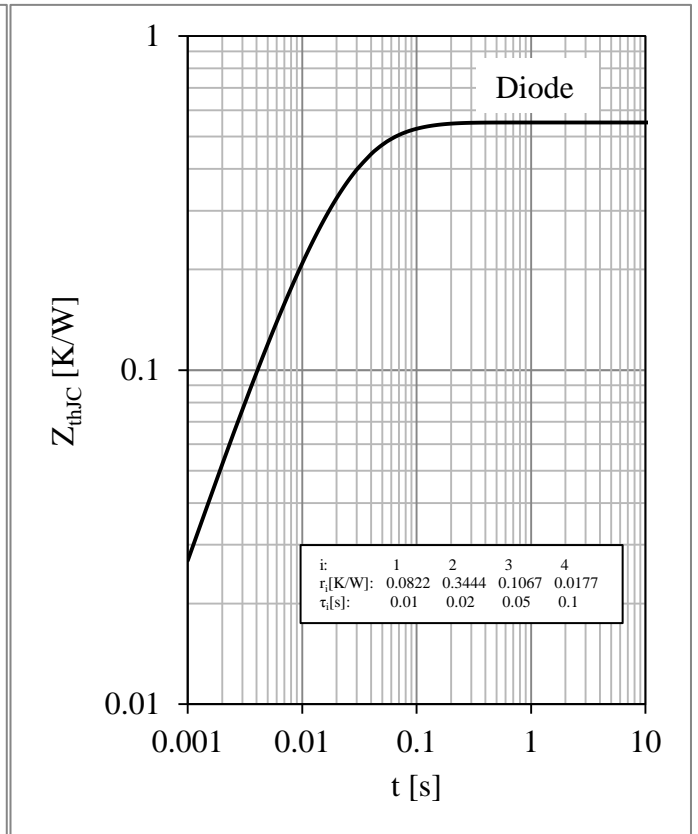

Fig 14. D5,D6 Diode Transient Thermal Impedance

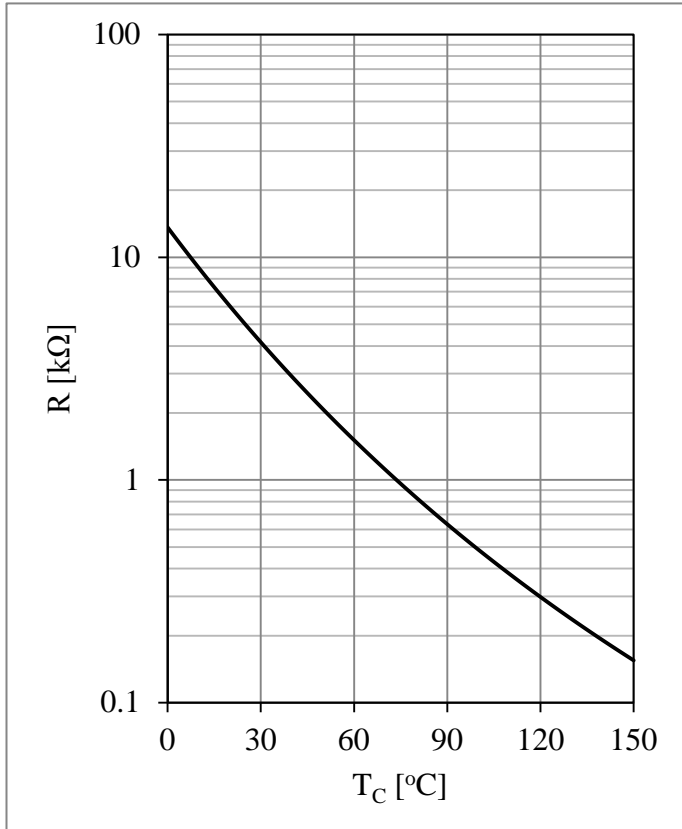
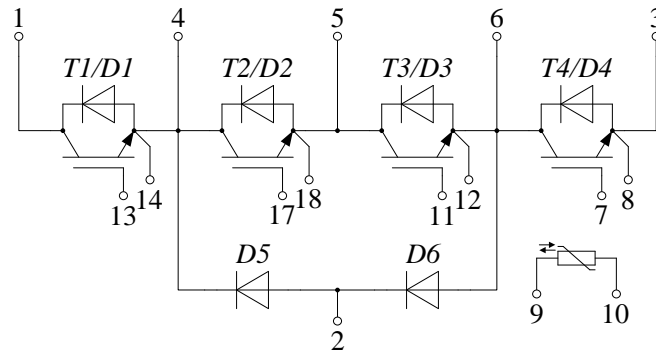

Fig 15. NTC Temperature Characteristic

**Circuit Schematic**



**Package Dimensions**

Dimensions in Millimeters

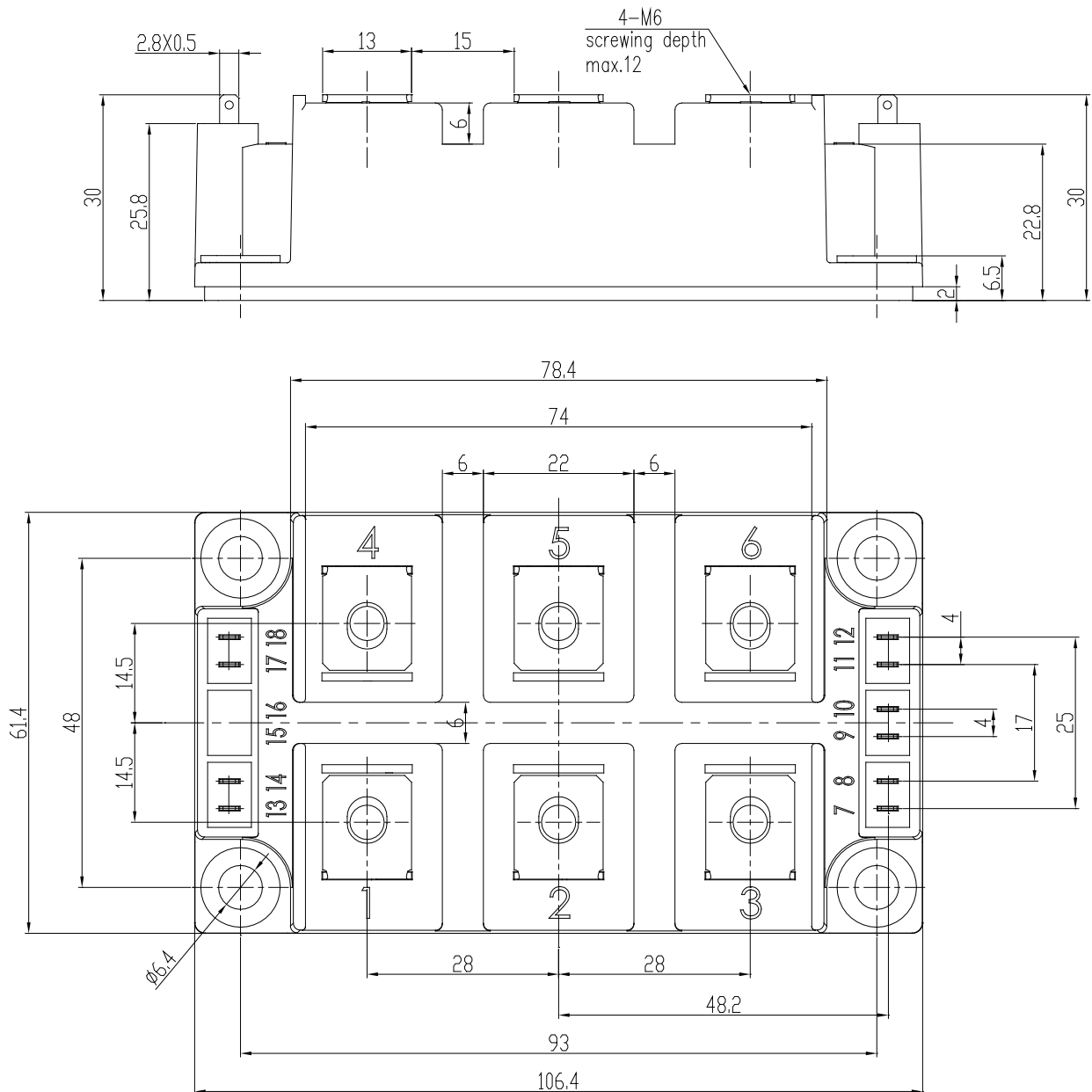

## Terms and Conditions of Usage

The data contained in this product datasheet is exclusively intended for technically trained staff. you and your technical departments will have to evaluate the suitability of the product for the intended application and the completeness of the product data with respect to such application.

This product data sheet is describing the characteristics of this product for which a warranty is granted. Any such warranty is granted exclusively pursuant the terms and conditions of the supply agreement. There will be no guarantee of any kind for the product and its characteristics.

Should you require product information in excess of the data given in this product data sheet or which concerns the specific application of our product, please contact the sales office, which is responsible for you (see [www.powersemi.cc](http://www.powersemi.cc)), For those that are specifically interested we may provide application notes.

Due to technical requirements our product may contain dangerous substances. For information on the types in question please contact the sales office, which is responsible for you.

Should you intend to use the Product in aviation applications, in health or live endangering or life support applications, please notify.

If and to the extent necessary, please forward equivalent notices to your customers.  
Changes of this product data sheet are reserved.