

STARPOWER

SEMICONDUCTOR

IGBT

GD150MLT170C2S

Molding Type Module

1700V/150A 3-level in one-package

General Description

STARPOWER IGBT Power Module provides ultra low conduction loss as well as short circuit ruggedness. They are designed for the applications such as 3-level-applications.



Features

- Low $V_{CE(sat)}$ trench IGBT technology
- Low switching loss
- 10 μ s short circuit capability
- Low inductance case
- $V_{CE(sat)}$ with positive temperature coefficient
- Fast & soft reverse recovery anti-parallel FWD
- Isolated copper baseplate using DBC technology

Typical Applications

- Solar power
- UPS
- 3-level-applications

IGBT T1 T2 T3 T4 $T_C=25^\circ\text{C}$ unless otherwise noted**Maximum Rated Values**

Symbol	Description	GD150MLT170C2S	Units
V_{CES}	Collector-Emitter Voltage @ $T_j=25^\circ\text{C}$	1700	V
V_{GES}	Gate-Emitter Voltage @ $T_j=25^\circ\text{C}$	± 20	V
I_C	Collector Current @ $T_C=25^\circ\text{C}$	260	A
	@ $T_C=80^\circ\text{C}$	150	
I_{CM}	Pulsed Collector Current $t_p=1\text{ms}$	300	A
P_{tot}	Total Power Dissipation @ $T_j=175^\circ\text{C}$	932	W

Off Characteristics

Symbol	Parameter	Test Conditions	Min.	Typ.	Max.	Units
$V_{(BR)CES}$	Collector-Emitter Breakdown Voltage	$T_j=25^\circ\text{C}$	1700			V
I_{CES}	Collector Cut-Off Current	$V_{CE}=V_{CES}, V_{GE}=0\text{V},$ $T_j=25^\circ\text{C}$			5.0	mA
I_{GES}	Gate-Emitter Leakage Current	$V_{GE}=V_{GES}, V_{CE}=0\text{V},$ $T_j=25^\circ\text{C}$			400	nA

On Characteristics

Symbol	Parameter	Test Conditions	Min.	Typ.	Max.	Units
$V_{GE(th)}$	Gate-Emitter Threshold Voltage	$I_C=6.0\text{mA}, V_{CE}=V_{GE},$ $T_j=25^\circ\text{C}$	5.2	5.8	6.4	V
$V_{CE(sat)}$	Collector to Emitter Saturation Voltage	$I_C=150\text{A}, V_{GE}=15\text{V},$ $T_j=25^\circ\text{C}$		2.00	2.45	V
		$I_C=150\text{A}, V_{GE}=15\text{V},$ $T_j=125^\circ\text{C}$		2.40		

Switching Characteristics

Symbol	Parameter	Test Conditions	Min.	Typ.	Max.	Units
$t_{d(on)}$	Turn-On Delay Time	$V_{CC}=900V, I_C=150A,$ $R_G=9.1\Omega, V_{GE}=\pm 15V,$ $T_j=25^\circ C$		282		ns
t_r	Rise Time			48		ns
$t_{d(off)}$	Turn-Off Delay Time			800		ns
t_f	Fall Time			178		ns
E_{on}	Turn-On Switching Loss			33.1		mJ
E_{off}	Turn-Off Switching Loss			32.2		mJ
$t_{d(on)}$	Turn-On Delay Time	$V_{CC}=900V, I_C=150A,$ $R_G=9.1\Omega, V_{GE}=\pm 15V,$ $T_j=125^\circ C$		301		ns
t_r	Rise Time			65		ns
$t_{d(off)}$	Turn-Off Delay Time			1000		ns
t_f	Fall Time			302		ns
E_{on}	Turn-On Switching Loss			47.8		mJ
E_{off}	Turn-Off Switching Loss			47.1		mJ
C_{ies}	Input Capacitance	$V_{CE}=25V, f=1MHz,$ $V_{GE}=0V$		13.3		nF
C_{oes}	Output Capacitance			0.55		nF
C_{res}	Reverse Transfer Capacitance			0.44		nF
Q_G	Gate Charge	$V_{CC}=900V, I_C=150A,$ $V_{GE}=-15 \dots +15V$		1.70		μC
R_{Gint}	Internal Gate Resister			5.0		Ω
I_{SC}	SC Data	$t_p \leq 10\mu s, V_{GE}=15V,$ $T_j=125^\circ C, V_{CC}=1000V,$ $V_{CEM} \leq 1700V$		600		A

Diode D1 D2 D3 D4 $T_C=25^\circ\text{C}$ unless otherwise noted**Maximum Rated Values**

Symbol	Description	GD150MLT170C2S	Units
V_{RRM}	Repetitive Peak Reverse Voltage @ $T_j=25^\circ\text{C}$	1700	V
I_F	DC Forward Current $T_C=80^\circ\text{C}$	150	A
I_{FRM}	Repetitive Peak Forward Current $t_p=1\text{ms}$	300	A

Characteristics Values

Symbol	Parameter	Test Conditions		Min.	Typ.	Max.	Units
V_F	Diode Forward Voltage	$I_F=150\text{A}$, $V_{GE}=0\text{V}$	$T_j=25^\circ\text{C}$		1.80	2.25	V
			$T_j=125^\circ\text{C}$		1.90		
Q_r	Recovered Charge	$I_F=150\text{A}$, $V_R=900\text{V}$, $R_G=9.1\Omega$, $V_{GE}=-15\text{V}$	$T_j=25^\circ\text{C}$		39.1		μC
			$T_j=125^\circ\text{C}$		65.8		
I_{RM}	Peak Reverse Recovery Current	$V_R=900\text{V}$, $R_G=9.1\Omega$, $V_{GE}=-15\text{V}$	$T_j=25^\circ\text{C}$		178		A
			$T_j=125^\circ\text{C}$		191		
E_{rec}	Reverse Recovery Energy	$V_{GE}=-15\text{V}$	$T_j=25^\circ\text{C}$		20.0		mJ
			$T_j=125^\circ\text{C}$		36.1		

Diode D5 D6 $T_C=25^\circ\text{C}$ unless otherwise noted**Maximum Rated Values**

Symbol	Description	GD150MLT170C2S	Units
V_{RRM}	Repetitive Peak Reverse Voltage @ $T_j=25^\circ\text{C}$	1700	V
I_F	DC Forward Current $T_C=80^\circ\text{C}$	150	A
I_{FRM}	Repetitive Peak Forward Current $t_p=1\text{ms}$	300	A

Characteristics Values

Symbol	Parameter	Test Conditions		Min.	Typ.	Max.	Units
V_F	Diode Forward Voltage	$I_F=150\text{A}$, $V_{GE}=0\text{V}$	$T_j=25^\circ\text{C}$		1.80	2.25	V
			$T_j=125^\circ\text{C}$		1.90		
Q_r	Recovered Charge	$I_F=150\text{A}$, $V_R=900\text{V}$, $R_G=9.1\Omega$, $V_{GE}=-15\text{V}$	$T_j=25^\circ\text{C}$		39.1		μC
			$T_j=125^\circ\text{C}$		65.8		
I_{RM}	Peak Reverse Recovery Current	$V_R=900\text{V}$, $R_G=9.1\Omega$, $V_{GE}=-15\text{V}$	$T_j=25^\circ\text{C}$		178		A
			$T_j=125^\circ\text{C}$		191		
E_{rec}	Reverse Recovery Energy	$V_{GE}=-15\text{V}$	$T_j=25^\circ\text{C}$		20.0		mJ
			$T_j=125^\circ\text{C}$		36.1		

NTC $T_C=25^{\circ}\text{C}$ unless otherwise noted

Symbol	Parameter	Test Conditions	Min.	Typ.	Max.	Units
R_{25}	Rated Resistance			5.0		$\text{k}\Omega$
$\Delta R/R$	Deviation of R_{100}	$T_C=100^{\circ}\text{C}, R_{100}=493.3\Omega$	-5		5	%
P_{25}	Power Dissipation				20.0	mW
$B_{25/50}$	B-value	$R_2=R_{25}\exp[B_{25/50}(1/T_2-1/(298.15\text{K}))]$		3375		K

IGBT Module

Symbol	Parameter	Min.	Typ.	Max.	Units
V_{ISO}	Isolation Voltage RMS, $f=50\text{Hz}, t=1\text{min}$	4000			V
$R_{\theta\text{JC}}$	Junction-to-Case (per IGBT T1 T2 T3 T4)			0.161	K/W
	Junction-to-Case (per Diode D1 D2 D3 D4)			0.337	
	Junction-to-Case (per Diode D5 D6)			0.346	
$R_{\theta\text{CS}}$	Case-to-Sink (Conductive grease applied)		0.035		K/W
T_{jmax}	Maximum Junction Temperature			175	$^{\circ}\text{C}$
T_{jop}	Operating Junction Temperature	-40		150	
T_{stg}	Storage Temperature Range	-40		125	$^{\circ}\text{C}$
Mounting Torque	Power Terminal Screw:M6	2.5		5.0	N.m
	Mounting Screw:M6	3.0		5.0	
Weight	Weight of Module		340		g

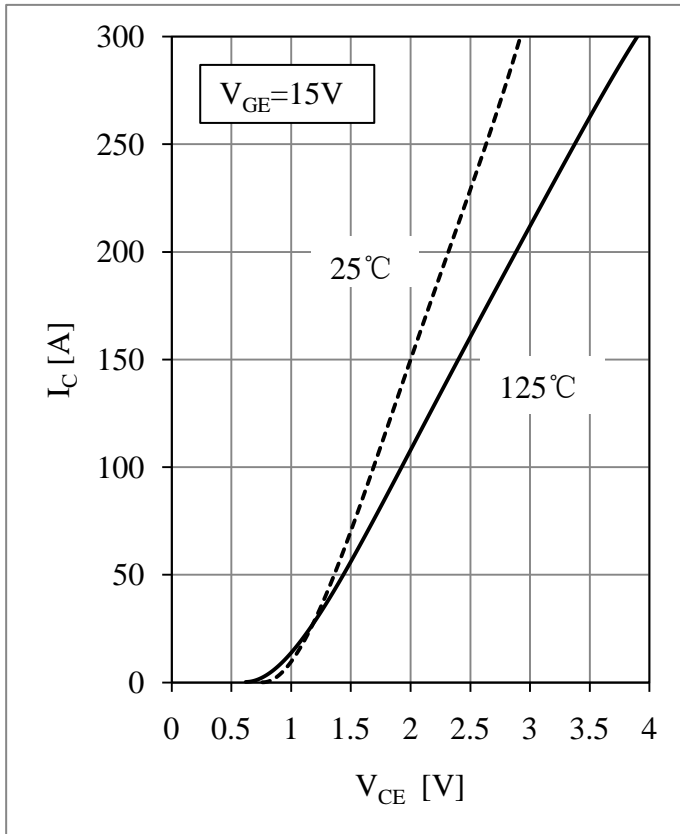

Fig 1. IGBT T1-T4 Output Characteristic

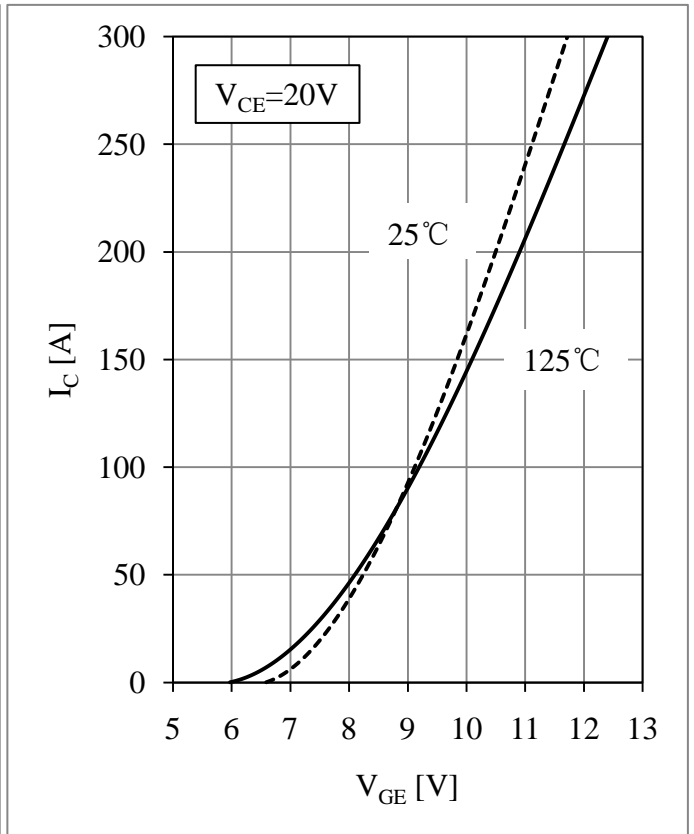

Fig 2. IGBT T1-T4 Transfer Characteristic

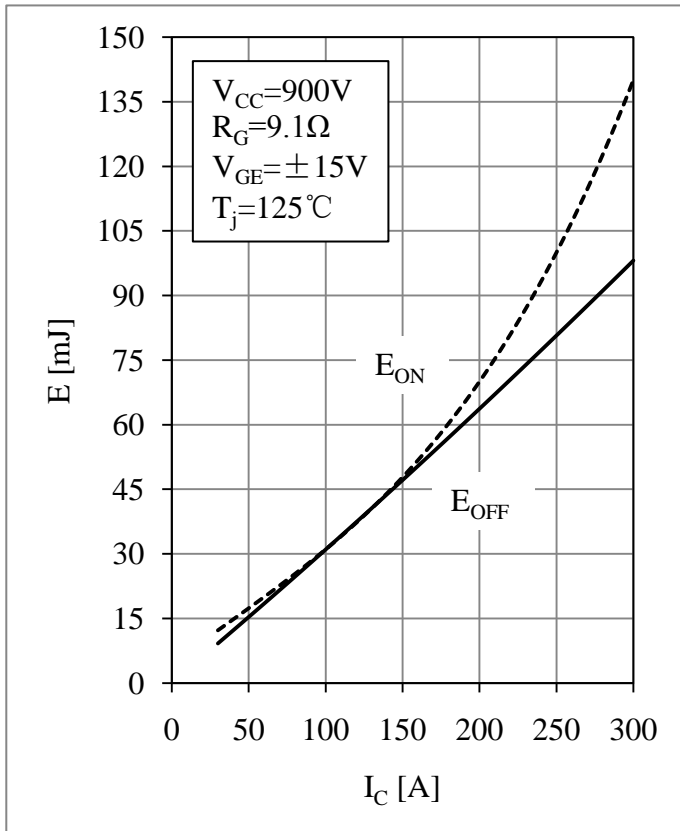

Fig 3. IGBT T1-T4 Switching Loss vs. I_C

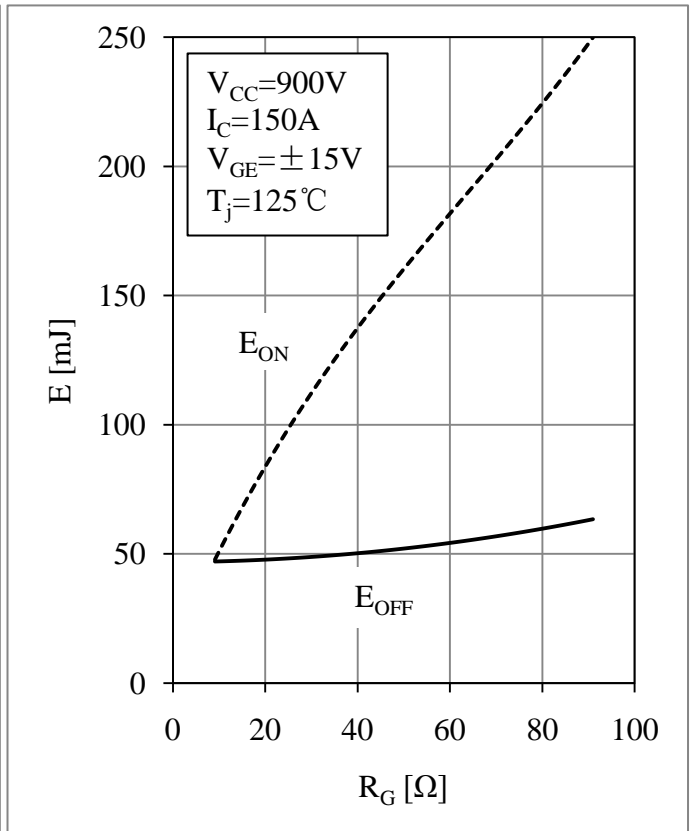

Fig 4. IGBT T1-T4 Switching Loss vs. R_G

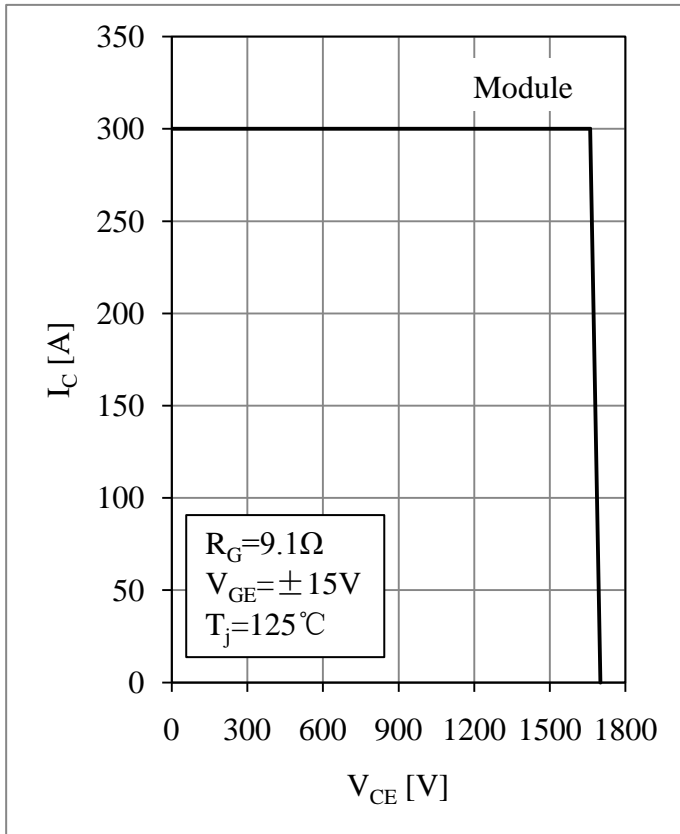

Fig 5. IGBT T1-T4 RBSOA

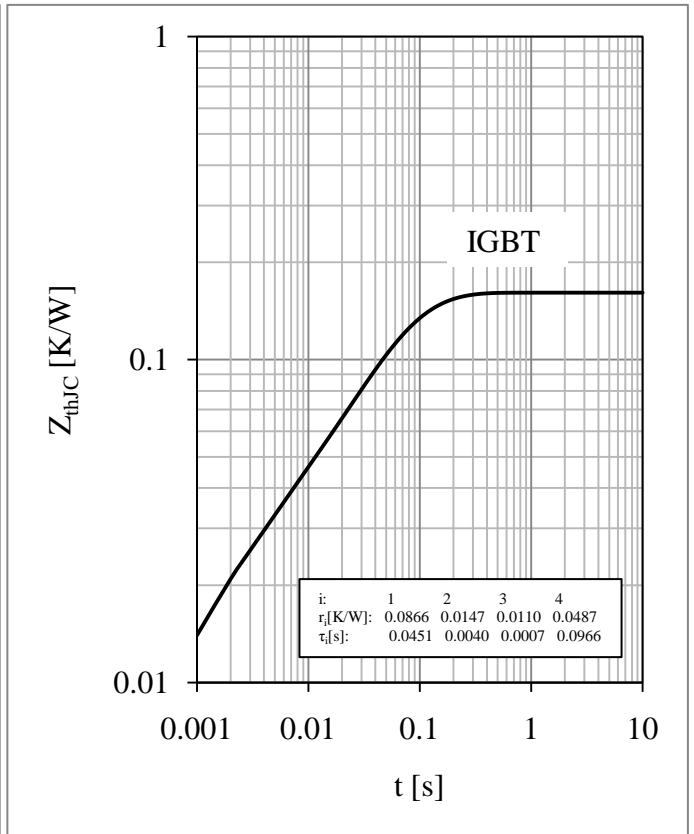

Fig 6. IGBT T1-T4 Transient Thermal Impedance

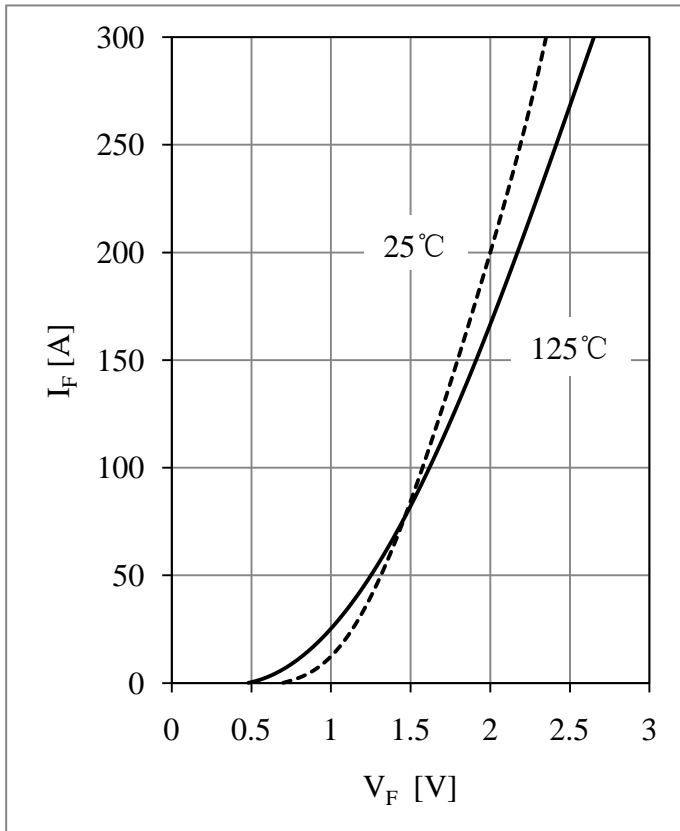

Fig 7. Diode D1-D4 Forward Characteristic

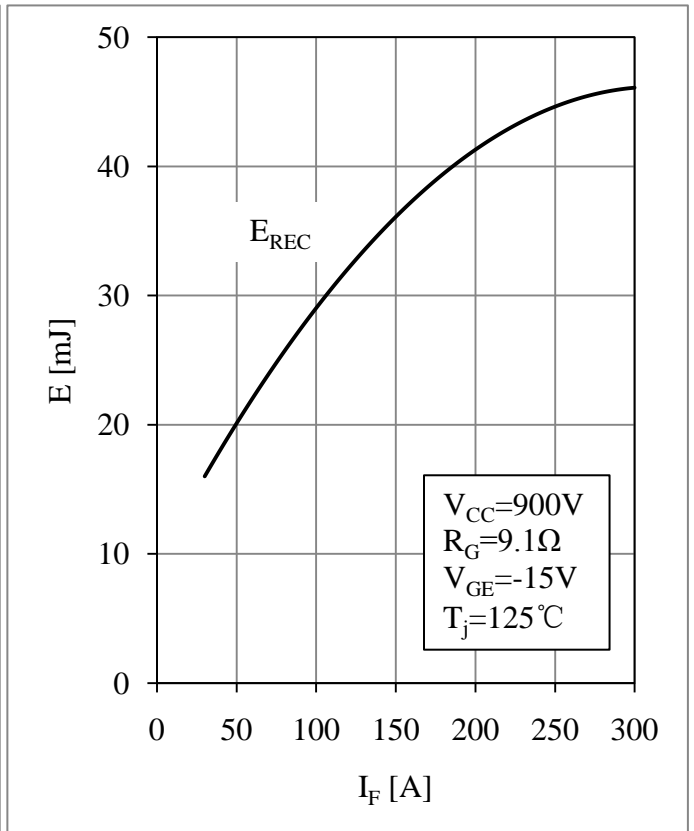

Fig 8. Diode D1-D4 Switching Loss vs. I_F

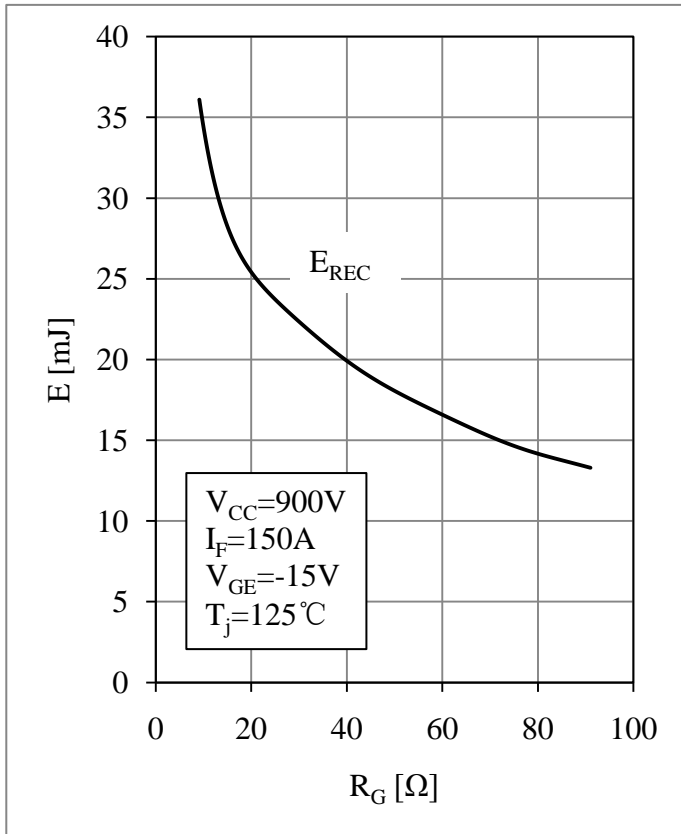

Fig 9. Diode D1-D4 Switching Loss vs. R_G

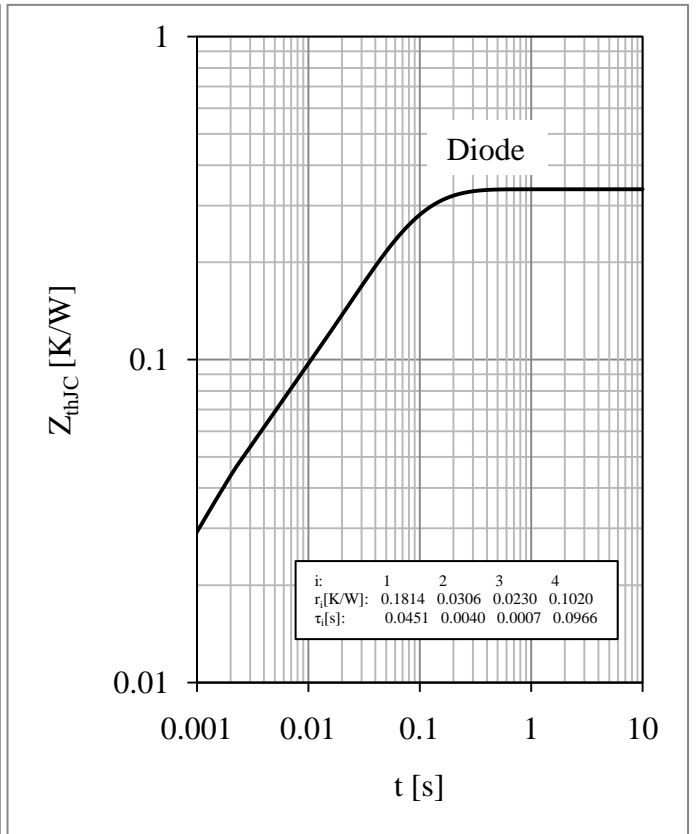

Fig 10. Diode D1-D4 Transient Thermal Impedance

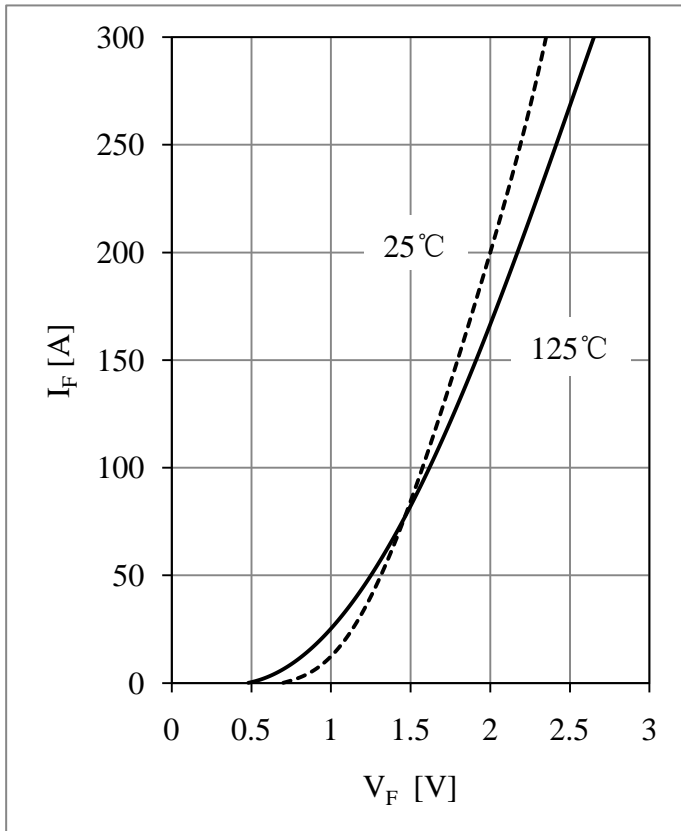

Fig 11. Diode D5-D6 Forward Characteristic

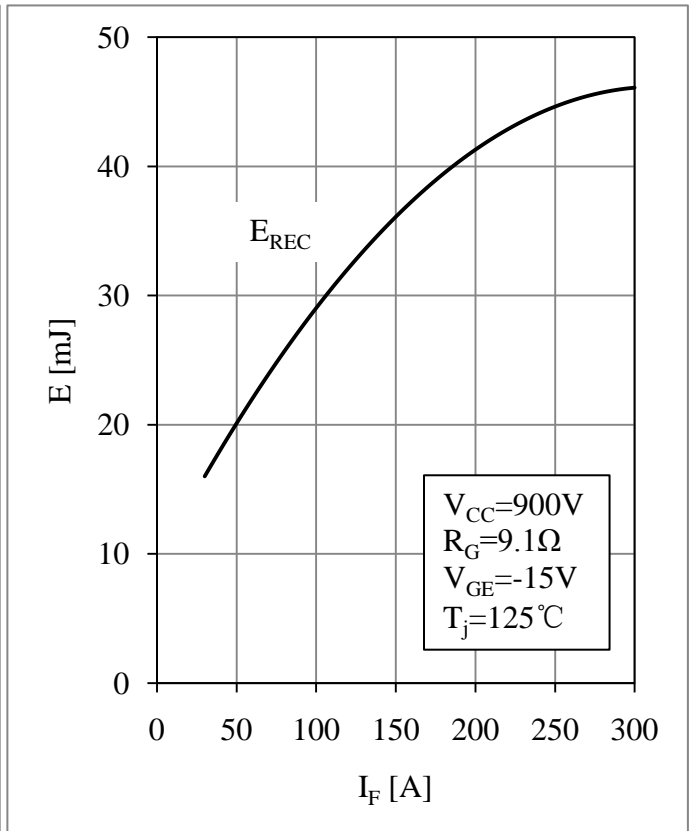

Fig 12. Diode D5-D6 Switching Loss vs. I_F

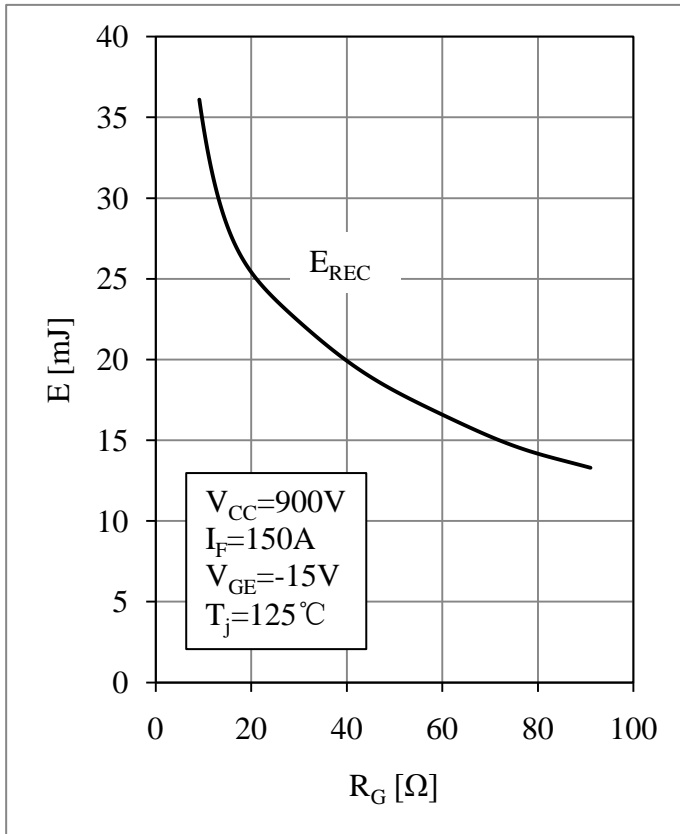

Fig 13. Diode D5-D6 Switching Loss vs. R_G

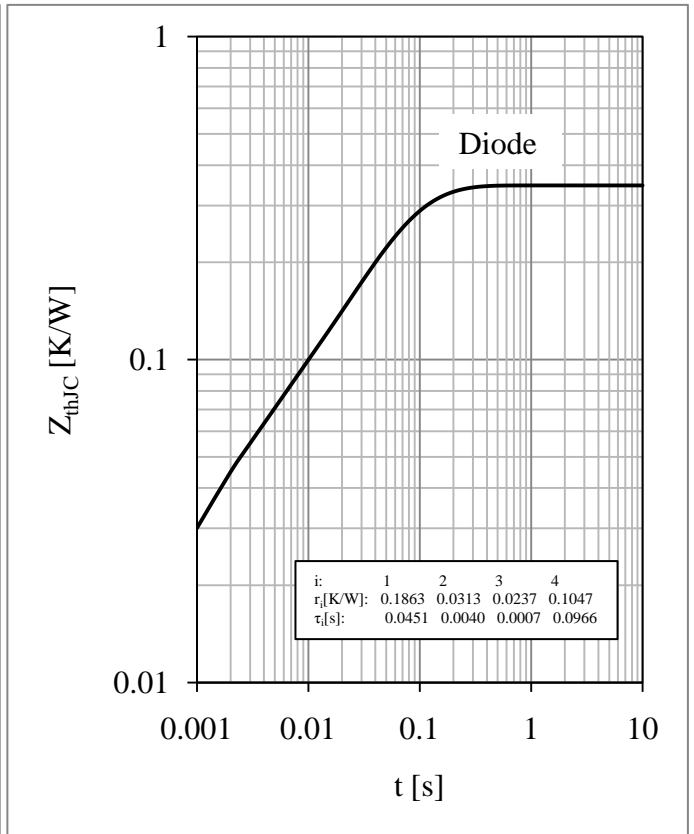

Fig 14. Diode D5-D6 Transient Thermal Impedance

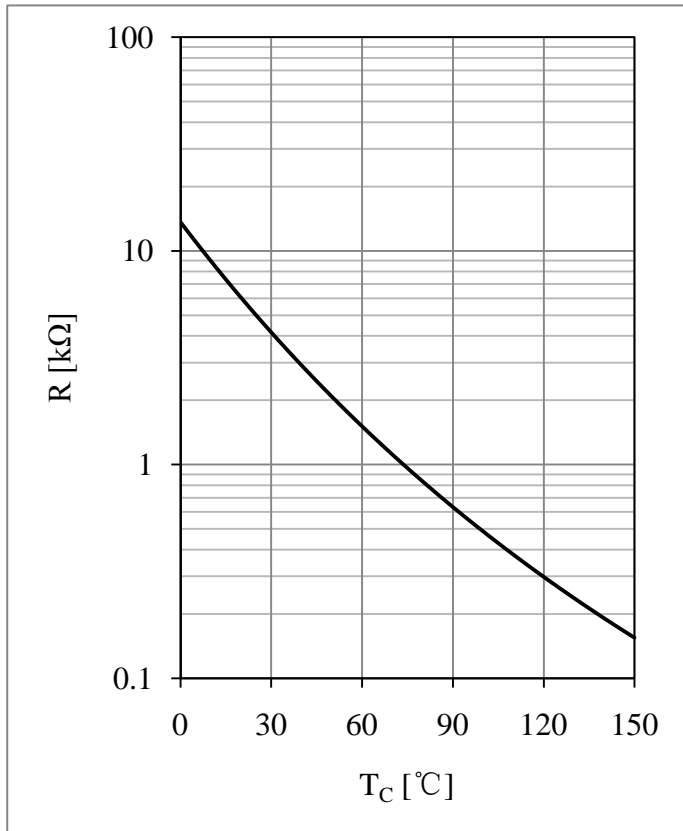
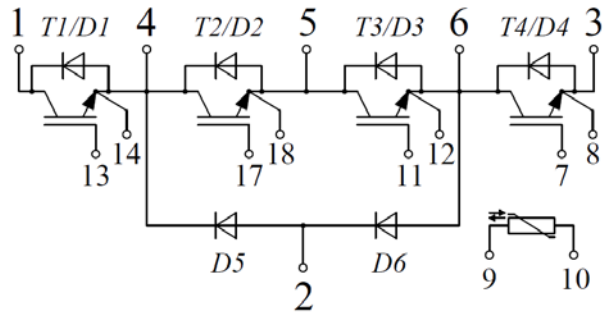

Fig 15. NTC Temperature Characteristic

Equivalent Circuit Schematic



Package Dimensions

Dimensions in Millimeters

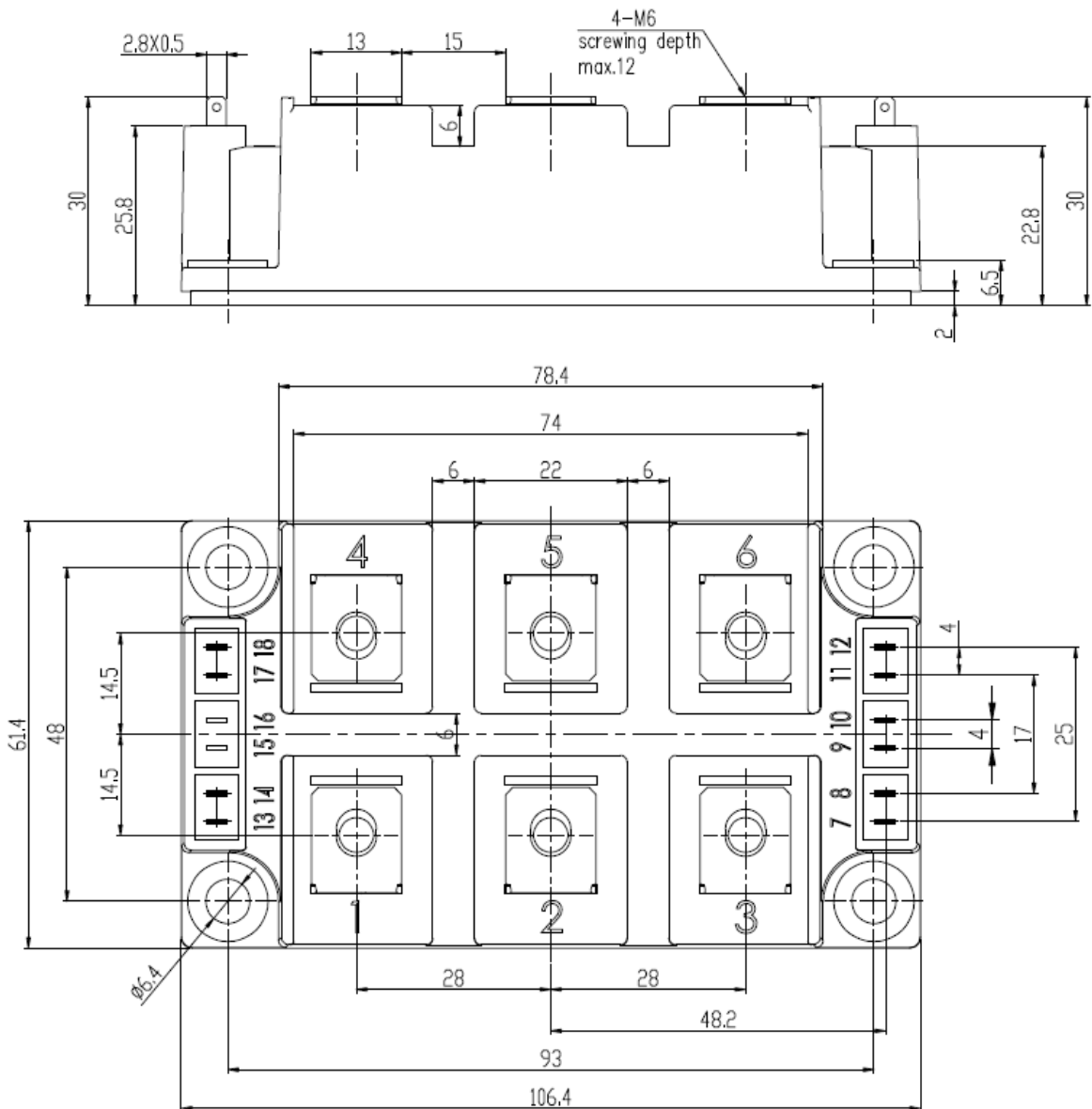

Terms and Conditions of Usage

The data contained in this product datasheet is exclusively intended for technically trained staff. you and your technical departments will have to evaluate the suitability of the product for the intended application and the completeness of the product data with respect to such application.

This product data sheet is describing the characteristics of this product for which a warranty is granted. Any such warranty is granted exclusively pursuant the terms and conditions of the supply agreement. There will be no guarantee of any kind for the product and its characteristics.

Should you require product information in excess of the data given in this product data sheet or which concerns the specific application of our product, please contact the sales office, which is responsible for you (see www.powersemi.cc), For those that are specifically interested we may provide application notes.

Due to technical requirements our product may contain dangerous substances. For information on the types in question please contact the sales office, which is responsible for you.

Should you intend to use the Product in aviation applications, in health or live endangering or life support applications, please notify.

If and to the extent necessary, please forward equivalent notices to your customers.
Changes of this product data sheet are reserved.