

STARPOWER

SEMICONDUCTOR

IGBT

GD150HFF120C1S

1200V/150A 2 in one-package

General Description

STARPOWER IGBT Power Module provides ultra switching speed as well as short circuit ruggedness. They are designed for the applications such as electronic welder and inductive heating.

Features

- Low $V_{CE(sat)}$ Trench IGBT technology
- $V_{CE(sat)}$ with positive temperature coefficient
- Low switching losses
- Maximum junction temperature 175°C
- Low inductance case
- Fast & soft reverse recovery anti-parallel FWD
- Isolated copper baseplate using DBC technology

Typical Applications

- Switching mode power supply
- Inductive heating
- Electronic welder

Equivalent Circuit Schematic

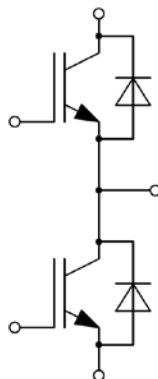

Absolute Maximum Ratings $T_C=25^{\circ}\text{C}$ unless otherwise noted**IGBT**

Symbol	Description	Value	Unit
V_{CES}	Collector-Emitter Voltage	1200	V
V_{GES}	Gate-Emitter Voltage	± 20	V
I_C	Collector Current @ $T_C=25^{\circ}\text{C}$	209	A
	@ $T_C=80^{\circ}\text{C}$	150	
I_{CM}	Pulsed Collector Current $t_p=1\text{ms}$	300	A
P_D	Maximum Power Dissipation @ $T_j=175^{\circ}\text{C}$	833	W

Diode

Symbol	Description	Value	Unit
V_{RRM}	Repetitive Peak Reverse Voltage	1200	V
I_F	Diode Continuous Forward Current	150	A
I_{FM}	Diode Maximum Forward Current $t_p=1\text{ms}$	300	A

Module

Symbol	Description	Value	Unit
T_{jmax}	Maximum Junction Temperature	175	$^{\circ}\text{C}$
T_{jop}	Operating Junction Temperature	-40 to +150	$^{\circ}\text{C}$
T_{STG}	Storage Temperature Range	-40 to +125	$^{\circ}\text{C}$
V_{ISO}	Isolation Voltage RMS, $f=50\text{Hz}$, $t=1\text{min}$	2500	V

IGBT Characteristics $T_c=25^\circ\text{C}$ unless otherwise noted

Symbol	Parameter	Test Conditions	Min.	Typ.	Max.	Unit	
$V_{CE(sat)}$	Collector to Emitter Saturation Voltage	$I_C=150\text{A}, V_{GE}=15\text{V}, T_j=25^\circ\text{C}$		2.05	2.50	V	
		$I_C=150\text{A}, V_{GE}=15\text{V}, T_j=125^\circ\text{C}$		2.55			
		$I_C=150\text{A}, V_{GE}=15\text{V}, T_j=150^\circ\text{C}$		2.70			
$V_{GE(th)}$	Gate-Emitter Threshold Voltage	$I_C=3.76\text{mA}, V_{CE}=V_{GE}, T_j=25^\circ\text{C}$	5.2	6.0	6.8	V	
I_{CES}	Collector Cut-Off Current	$V_{CE}=V_{CES}, V_{GE}=0\text{V}, T_j=25^\circ\text{C}$			1.0	mA	
I_{GES}	Gate-Emitter Leakage Current	$V_{GE}=V_{GES}, V_{CE}=0\text{V}, T_j=25^\circ\text{C}$			100	nA	
R_{Gint}	Internal Gate Resistance			2.5		Ω	
$t_{d(on)}$	Turn-On Delay Time	$V_{CC}=600\text{V}, I_C=150\text{A}, R_G=1.1\Omega, V_{GE}=\pm 15\text{V}, T_j=25^\circ\text{C}$		200		ns	
t_r	Rise Time			28		ns	
$t_{d(off)}$	Turn-Off Delay Time			210		ns	
t_f	Fall Time			209		ns	
E_{on}	Turn-On Switching Loss				5.46		mJ
E_{off}	Turn-Off Switching Loss				8.40		mJ
$t_{d(on)}$	Turn-On Delay Time	$V_{CC}=600\text{V}, I_C=150\text{A}, R_G=1.1\Omega, V_{GE}=\pm 15\text{V}, T_j=125^\circ\text{C}$		219		ns	
t_r	Rise Time			33		ns	
$t_{d(off)}$	Turn-Off Delay Time			235		ns	
t_f	Fall Time			225		ns	
E_{on}	Turn-On Switching Loss				10.7		mJ
E_{off}	Turn-Off Switching Loss				8.94		mJ
$t_{d(on)}$	Turn-On Delay Time	$V_{CC}=600\text{V}, I_C=150\text{A}, R_G=1.1\Omega, V_{GE}=\pm 15\text{V}, T_j=150^\circ\text{C}$		233		ns	
t_r	Rise Time			31		ns	
$t_{d(off)}$	Turn-Off Delay Time			319		ns	
t_f	Fall Time			153		ns	
E_{on}	Turn-On Switching Loss				11.5		mJ
E_{off}	Turn-Off Switching Loss				11.5		mJ

Diode Characteristics $T_C=25^\circ\text{C}$ unless otherwise noted

Symbol	Parameter	Test Conditions	Min.	Typ.	Max.	Unit
V_F	Diode Forward Voltage	$I_F=150\text{A}, V_{GE}=0\text{V}, T_j=25^\circ\text{C}$		2.15	2.60	V
		$I_F=150\text{A}, V_{GE}=0\text{V}, T_j=125^\circ\text{C}$		2.15		
		$I_F=150\text{A}, V_{GE}=0\text{V}, T_j=150^\circ\text{C}$		2.15		
Q_r	Recovered Charge			12.0		μC
I_{RM}	Peak Reverse Recovery Current	$V_R=600\text{V}, I_F=150\text{A},$ $-di/dt=4600\text{A}/\mu\text{s}, V_{GE}=-15\text{V}$ $T_j=25^\circ\text{C}$		148		A
E_{rec}	Reverse Recovery Energy			5.34		mJ
Q_r	Recovered Charge			18.8		μC
I_{RM}	Peak Reverse Recovery Current	$V_R=600\text{V}, I_F=150\text{A},$ $-di/dt=4600\text{A}/\mu\text{s}, V_{GE}=-15\text{V}$ $T_j=125^\circ\text{C}$		140		A
E_{rec}	Reverse Recovery Energy			7.22		mJ
Q_r	Recovered Charge			19.2		μC
I_{RM}	Peak Reverse Recovery Current	$V_R=600\text{V}, I_F=150\text{A},$ $-di/dt=4600\text{A}/\mu\text{s}, V_{GE}=-15\text{V}$ $T_j=150^\circ\text{C}$		126		A
E_{rec}	Reverse Recovery Energy			7.48		mJ

Module Characteristics $T_C=25^\circ\text{C}$ unless otherwise noted

Symbol	Parameter	Min.	Typ.	Max.	Unit
L_{CE}	Stray Inductance		30		nH
$R_{CC'+EE'}$	Module Lead Resistance, Terminal to Chip		0.75		m Ω
R_{thJC}	Junction-to-Case (per IGBT)			0.180	K/W
	Junction-to-Case (per Diode)			0.265	
R_{thCH}	Case-to-Heatsink (per IGBT)		0.168		K/W
	Case-to-Heatsink (per Diode)		0.247		
	Case-to-Heatsink (per Module)		0.050		
M	Terminal Connection Torque, Screw M5	2.5		5.0	N.m
	Mounting Torque, Screw M6	3.0		5.0	
G	Weight of Module		150		g

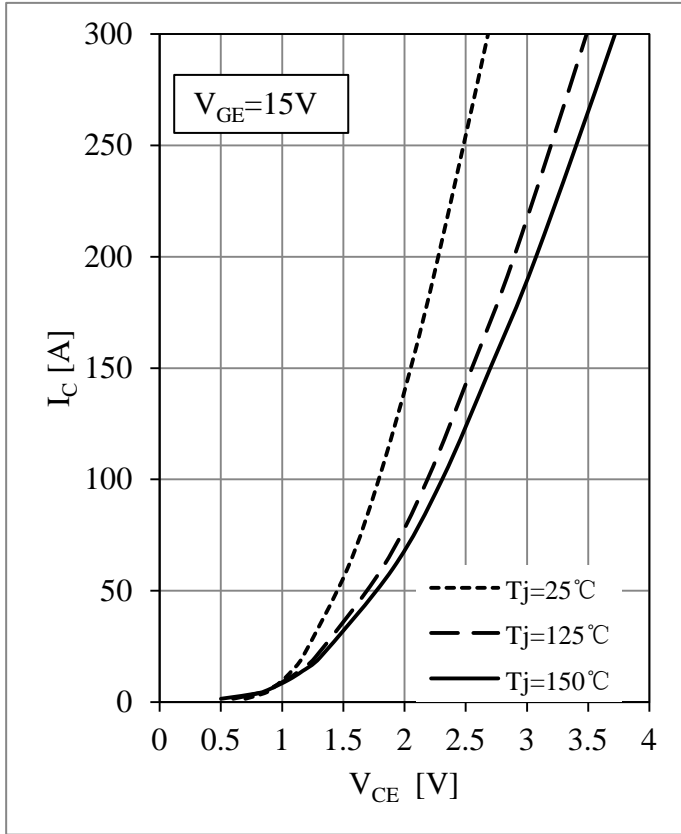

Fig 1. IGBT Output Characteristics

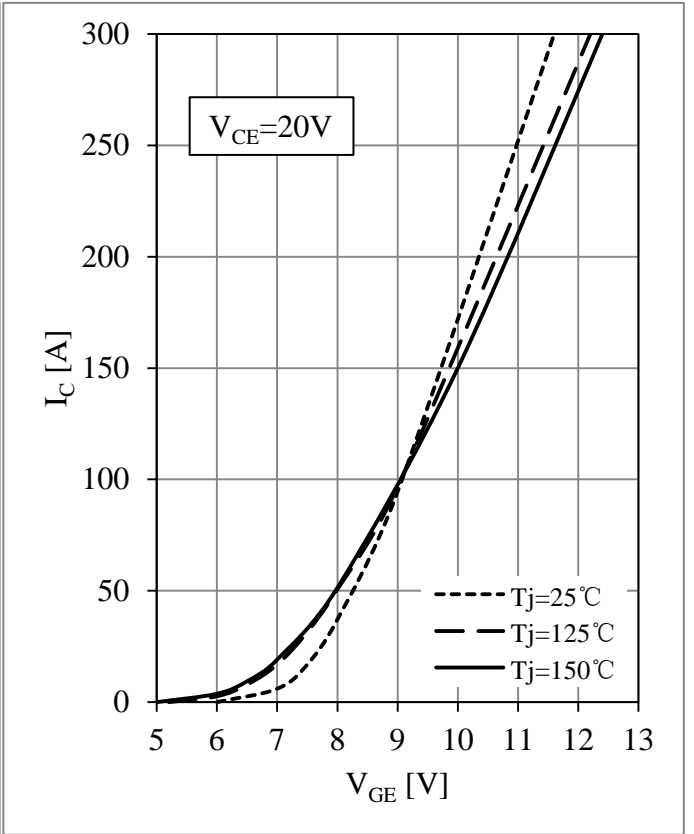

Fig 2. IGBT Transfer Characteristics

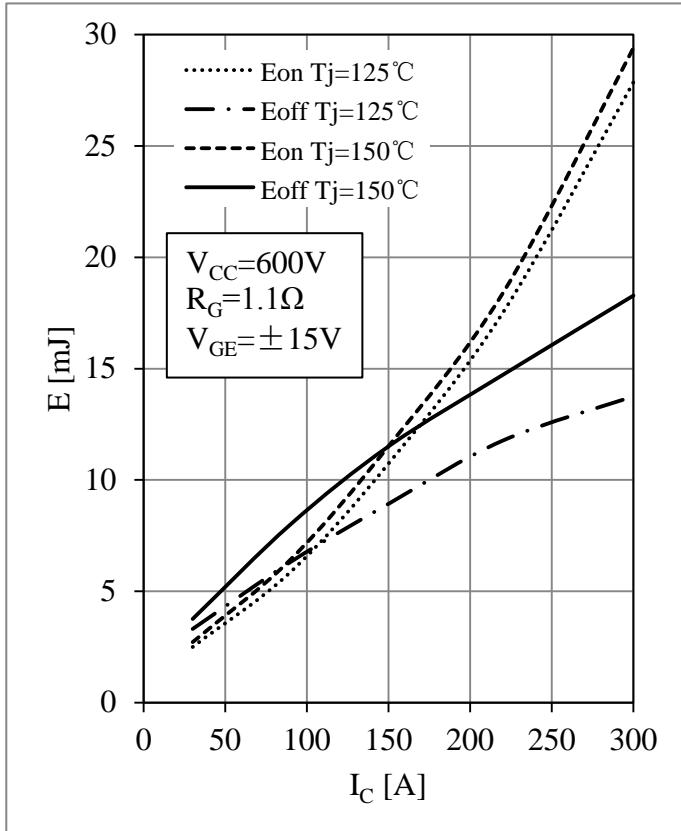

Fig 3. IGBT Switching Loss vs. I_C

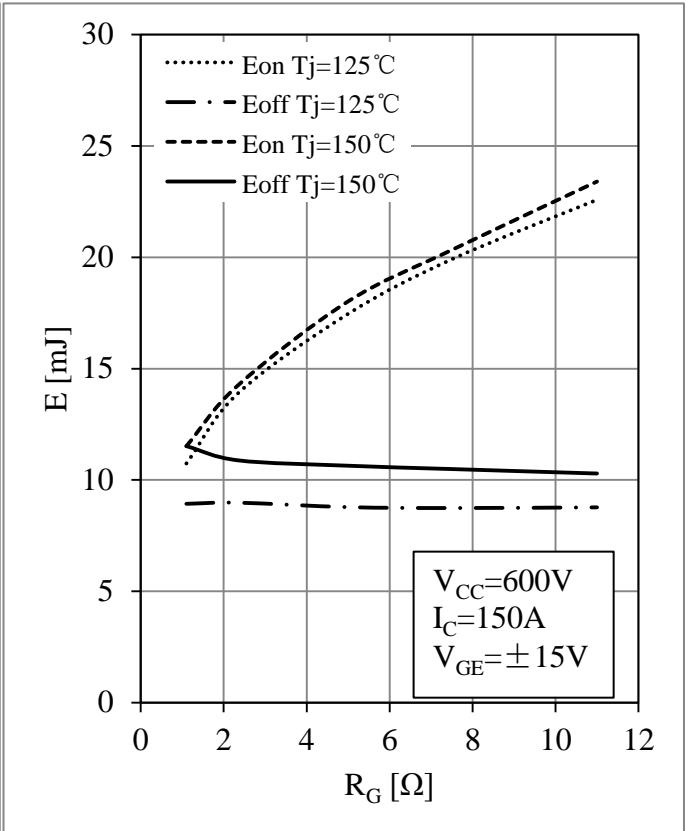

Fig 4. IGBT Switching Loss vs. R_G

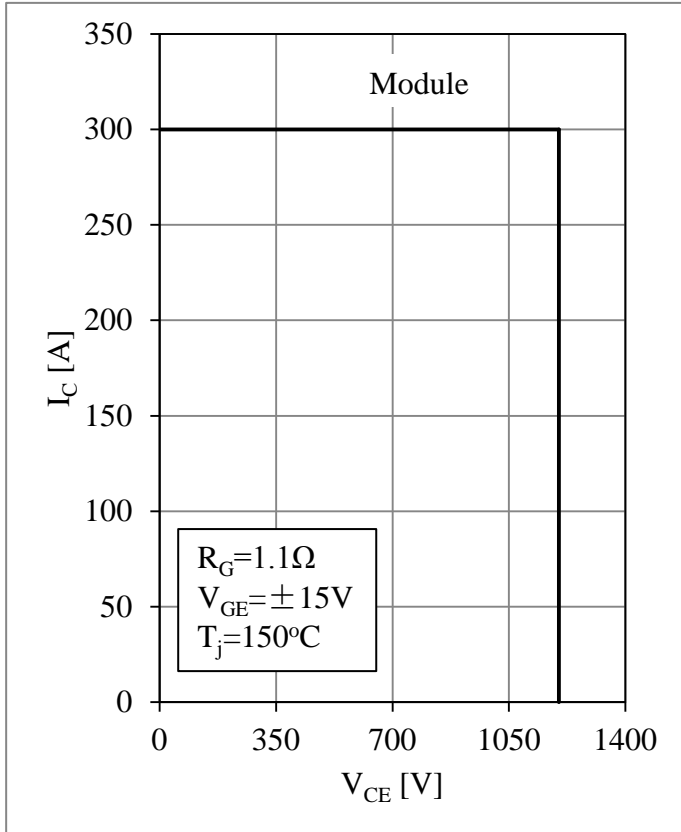

Fig 5. RBSOA

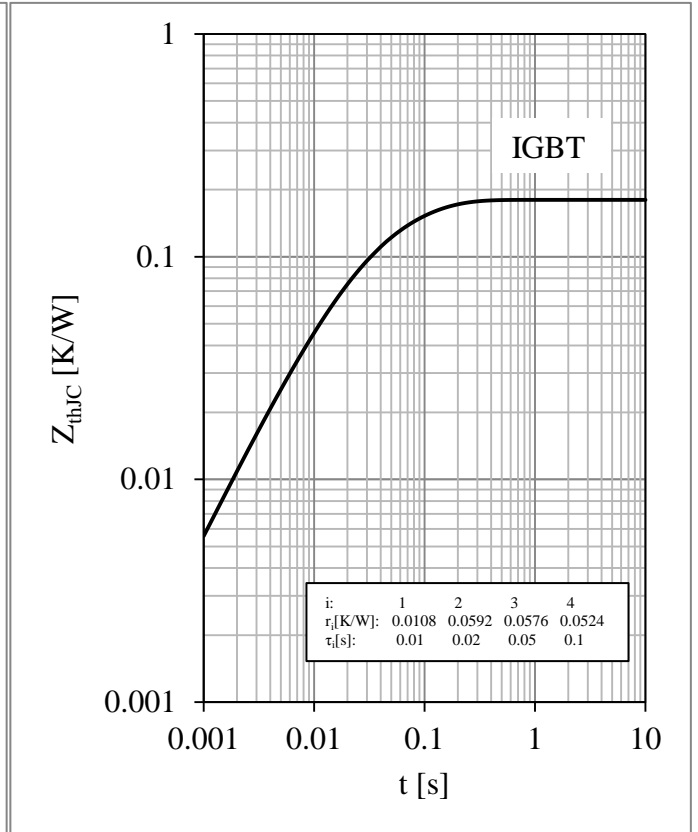

Fig 6. IGBT Transient Thermal Impedance

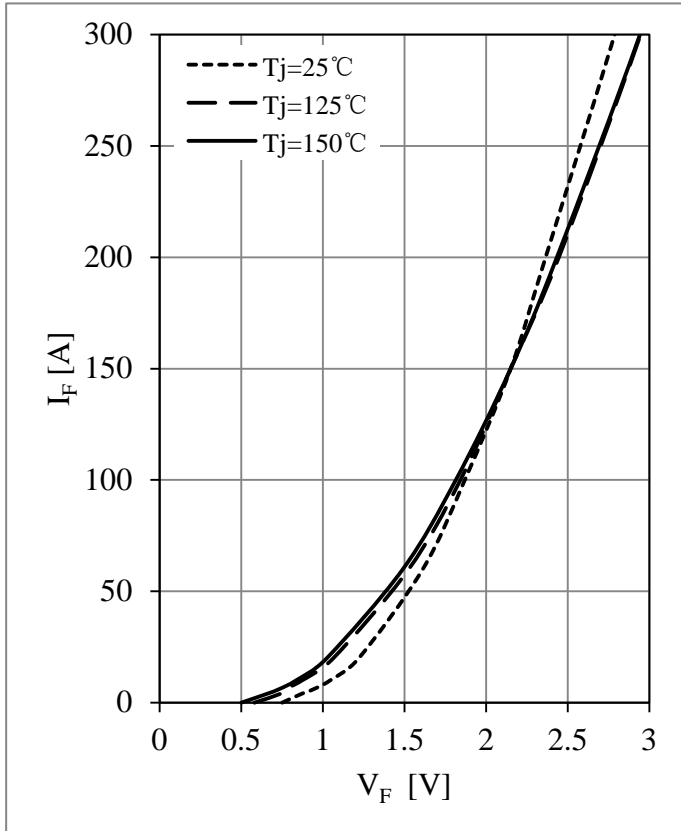

Fig 7. Diode Forward Characteristics

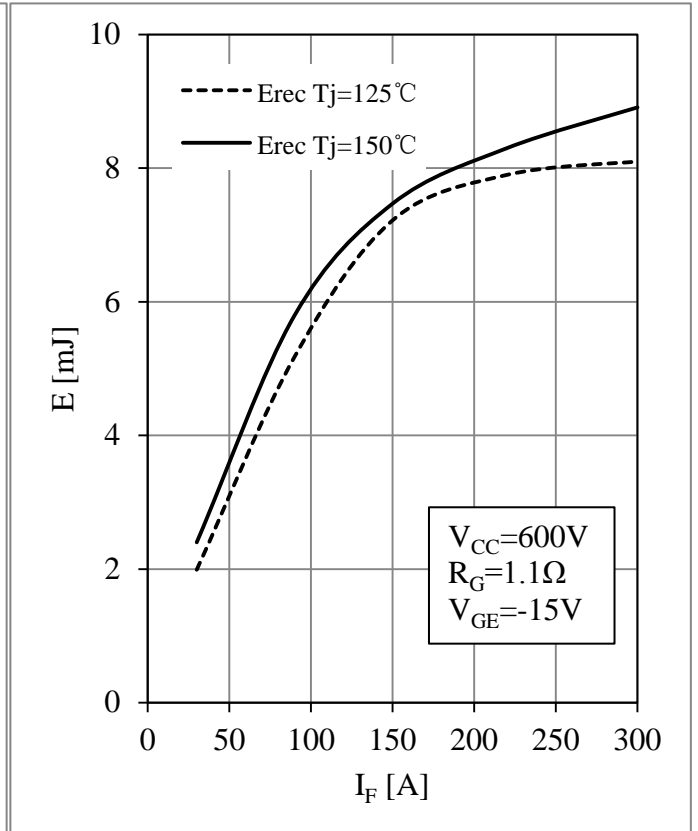

Fig 8. Diode Switching Loss vs. I_F

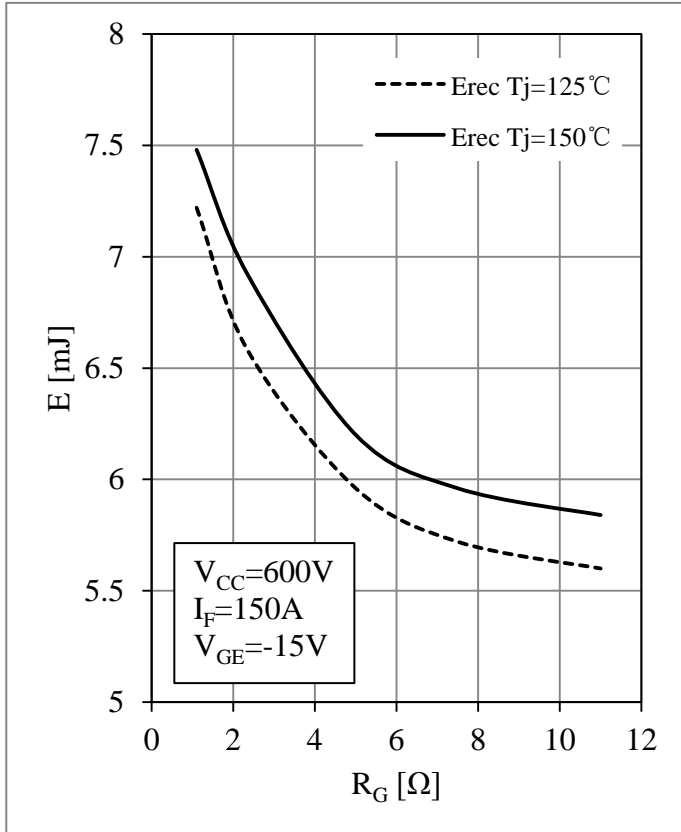

Fig 9. Diode Switching Loss vs. R_G

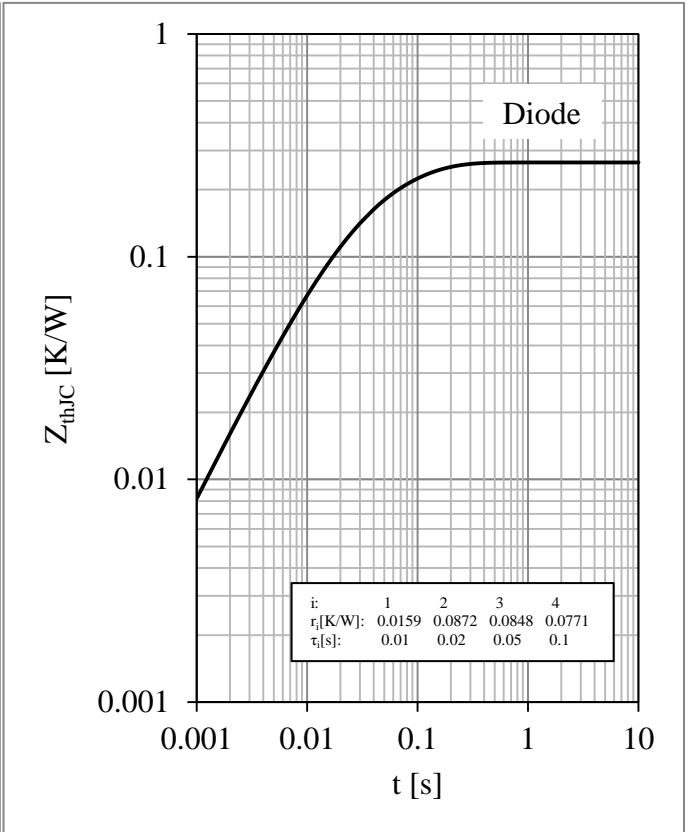

Fig 10. Diode Transient Thermal Impedance

Circuit Schematic



Package Dimensions

Dimensions in Millimeters

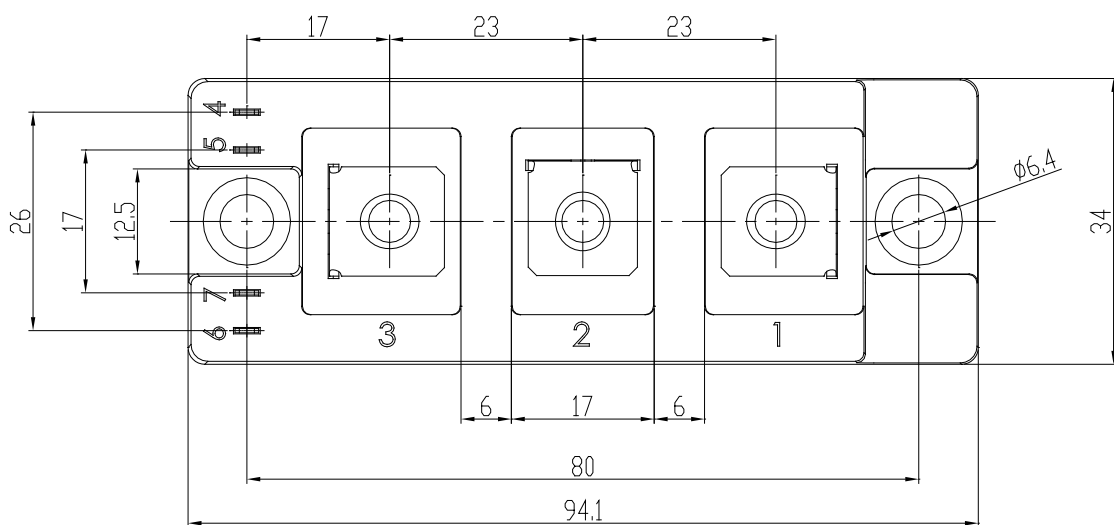
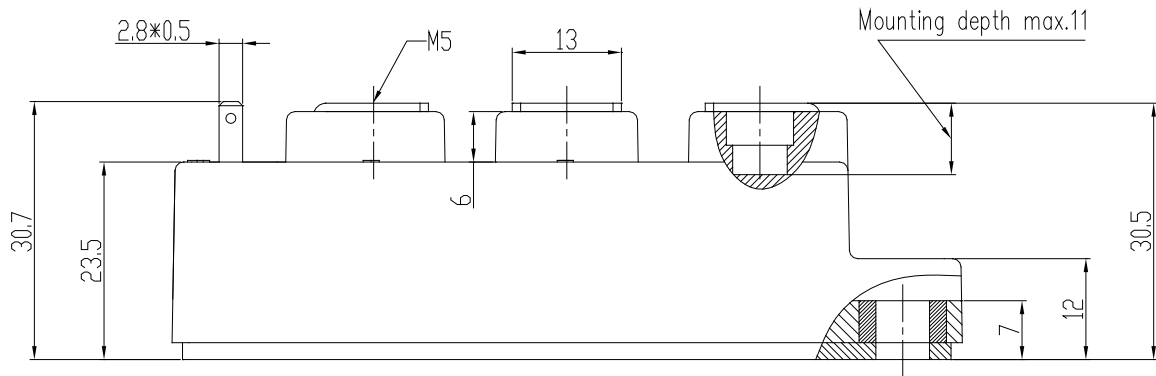

Terms and Conditions of Usage

The data contained in this product datasheet is exclusively intended for technically trained staff. you and your technical departments will have to evaluate the suitability of the product for the intended application and the completeness of the product data with respect to such application.

This product data sheet is describing the characteristics of this product for which a warranty is granted. Any such warranty is granted exclusively pursuant the terms and conditions of the supply agreement. There will be no guarantee of any kind for the product and its characteristics.

Should you require product information in excess of the data given in this product data sheet or which concerns the specific application of our product, please contact the sales office, which is responsible for you (see www.powersemi.cc), For those that are specifically interested we may provide application notes.

Due to technical requirements our product may contain dangerous substances. For information on the types in question please contact the sales office, which is responsible for you.

Should you intend to use the Product in aviation applications, in health or live endangering or life support applications, please notify.

If and to the extent necessary, please forward equivalent notices to your customers.
Changes of this product data sheet are reserved.