

STARPOWER

SEMICONDUCTOR

IGBT

GD10PJK120F3S

Molding Type Module

1200V/10A PIM in one-package

General Description

STARPOWER IGBT Power Module provides ultra low conduction and switching loss as well as short circuit ruggedness. They are designed for the applications such as general inverters and UPS.

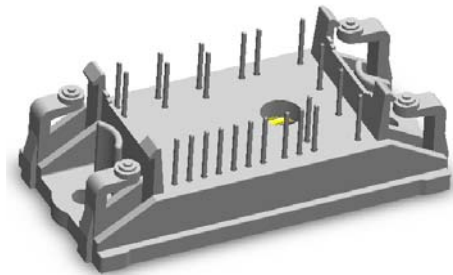

Features

- Low $V_{CE(sat)}$ NPT IGBT technology
- 10 μ s short circuit capability
- Square RBSOA
- $V_{CE(sat)}$ with positive temperature coefficient
- Fast & soft reverse recovery anti-parallel FWD

Typical Applications

- Inverter for motor drive
- AC and DC servo drive amplifier
- Uninterruptible power supply

IGBT-inverter $T_C=25^\circ\text{C}$ unless otherwise noted**Maximum Rated Values**

Symbol	Description	GD10PJK120F3S	Units
V_{CES}	Collector-Emitter Voltage @ $T_j=25^\circ\text{C}$	1200	V
V_{GES}	Gate-Emitter Voltage @ $T_j=25^\circ\text{C}$	± 20	V
I_C	Collector Current @ $T_C=25^\circ\text{C}$ @ $T_C=80^\circ\text{C}$	20 10	A
I_{CM}	Pulsed Collector Current $t_p=1\text{ms}$	20	A
P_{tot}	Total Power Dissipation @ $T_j=150^\circ\text{C}$	94	W

Off Characteristics

Symbol	Parameter	Test Conditions	Min.	Typ.	Max.	Units
$V_{(BR)CES}$	Collector-Emitter Breakdown Voltage	$T_j=25^\circ\text{C}$	1200			V
I_{CES}	Collector Cut-Off Current	$V_{CE}=V_{CES}, V_{GE}=0\text{V},$ $T_j=25^\circ\text{C}$			1.0	mA
I_{GES}	Gate-Emitter Leakage Current	$V_{GE}=V_{GES}, V_{CE}=0\text{V},$ $T_j=25^\circ\text{C}$			400	nA

On Characteristics

Symbol	Parameter	Test Conditions	Min.	Typ.	Max.	Units
$V_{GE(th)}$	Gate-Emitter Threshold Voltage	$I_C=125\mu\text{A}, V_{CE}=V_{GE},$ $T_j=25^\circ\text{C}$	4.4	5.0	6.0	V
$V_{CE(sat)}$	Collector to Emitter Saturation Voltage	$I_C=10\text{A}, V_{GE}=15\text{V},$ $T_j=25^\circ\text{C}$		2.45	2.90	V
		$I_C=10\text{A}, V_{GE}=15\text{V},$ $T_j=125^\circ\text{C}$		2.75		

Switching Characteristics

Symbol	Parameter	Test Conditions	Min.	Typ.	Max.	Units
$t_{d(on)}$	Turn-On Delay Time	$V_{CC}=600V, I_C=10A,$ $R_G=100\Omega, V_{GE}=\pm 15V,$ $T_j=25^\circ C$		172		ns
t_r	Rise Time			55		ns
$t_{d(off)}$	Turn-Off Delay Time			189		ns
t_f	Fall Time			312		ns
E_{on}	Turn-On Switching Loss			2.34		mJ
E_{off}	Turn-Off Switching Loss			0.74		mJ
$t_{d(on)}$	Turn-On Delay Time	$V_{CC}=600V, I_C=10A,$ $R_G=100\Omega, V_{GE}=\pm 15V,$ $T_j=125^\circ C$		176		ns
t_r	Rise Time			58		ns
$t_{d(off)}$	Turn-Off Delay Time			199		ns
t_f	Fall Time			443		ns
E_{on}	Turn-On Switching Loss			2.71		mJ
E_{off}	Turn-Off Switching Loss			0.98		mJ
C_{ies}	Input Capacitance	$V_{CE}=30V, f=1Mhz,$ $V_{GE}=0V$		795		pF
C_{oes}	Output Capacitance			64		pF
C_{res}	Reverse Transfer Capacitance			25		pF
Q_G	Gate Charge	$V_{CC}=600V, I_C=10A,$ $V_{GE}=15V$		48		nC
R_{Gint}	Internal Gate Resister			/		Ω
I_{SC}	SC Data	$t_p \leq 10\mu s, V_{GE}=15V,$ $T_j=125^\circ C, V_{CC}=900V,$ $V_{CEM} \leq 1200V$		72		A

Diode-inverter $T_C=25^\circ C$ unless otherwise noted

Maximum Rated Values

Symbol	Description	GD10PJK120F3S	Units
V_{RRM}	Repetitive Peak Reverse Voltage @ $T_j=25^\circ C$	1200	V
I_F	DC Forward Current	10	A
I_{FRM}	Repetitive Peak Forward Current $t_p=1ms$	20	A

Characteristics Values

Symbol	Parameter	Test Conditions	Min.	Typ.	Max.	Units
V_F	Diode Forward Voltage	$I_F=10A, V_{GE}=0V$	$T_j=25^\circ C$	1.85	2.30	V
			$T_j=125^\circ C$	2.05		
Q_r	Recovered Charge	$I_F=10A,$	$T_j=25^\circ C$	0.98		μC
			$T_j=125^\circ C$	1.51		
I_{RM}	Peak Reverse Recovery Current	$V_R=600V,$ $R_G=100\Omega,$	$T_j=25^\circ C$	6.6		A
			$T_j=125^\circ C$	8.0		
E_{rec}	Reverse Recovery Energy	$V_{GE}=-15V$	$T_j=25^\circ C$	0.36		mJ
			$T_j=125^\circ C$	0.53		

Diode-rectifier $T_C=25^\circ\text{C}$ unless otherwise noted**Maximum Rated Values**

Symbol	Description	GD10PJK120F3S	Units
V_{RRM}	Repetitive Peak Reverse Voltage @ $T_j=25^\circ\text{C}$	1600	V
$I_{F(AV)}$	Average On-state Current @ $T_C=100^\circ\text{C}$	20	A
I_{RMSM}	Maximum RMS Current At Rectifier Output @ $T_C=80^\circ\text{C}$	40	A
I_{FSM}	Surge Forward Current $V_R=0V, t_p=10\text{ms}, T_j=45^\circ\text{C}$	270	A
I^2t	I^2t -value, $V_R=0V, t_p=10\text{ms}, T_j=45^\circ\text{C}$	360	A^2s

Characteristics Values

Symbol	Parameter	Test Conditions	Min.	Typ.	Max.	Units
V_F	Diode Forward Voltage	$I_F=20\text{A}$ $T_j=150^\circ\text{C}$		1.11		V
I_R	Reverse Current	$T_j=150^\circ\text{C}, V_R=1600\text{V}$			1.0	mA

IGBT-brake-chopper $T_C=25^\circ\text{C}$ unless otherwise noted**Maximum Rated Values**

Symbol	Description	GD10PJK120F3S	Units
V_{CES}	Collector-Emitter Voltage @ $T_j=25^\circ\text{C}$	1200	V
V_{GES}	Gate-Emitter Voltage @ $T_j=25^\circ\text{C}$	± 30	V
I_C	Collector Current @ $T_C=25^\circ\text{C}$ @ $T_C=80^\circ\text{C}$	20 10	A
I_{CM}	Pulsed Collector Current $t_p=1\text{ms}$	20	A
P_{tot}	Total Power Dissipation @ $T_j=175^\circ\text{C}$	94	W

Off Characteristics

Symbol	Parameter	Test Conditions	Min.	Typ.	Max.	Units
$V_{(BR)CES}$	Collector-Emitter Breakdown Voltage	$T_j=25^\circ\text{C}$	1200			V
I_{CES}	Collector Cut-Off Current	$V_{CE}=V_{CES}, V_{GE}=0V,$ $T_j=25^\circ\text{C}$			1.0	mA
I_{GES}	Gate-Emitter Leakage Current	$V_{GE}=V_{GES}, V_{CE}=0V,$ $T_j=25^\circ\text{C}$			400	nA

On Characteristics

Symbol	Parameter	Test Conditions	Min.	Typ.	Max.	Units
$V_{GE(th)}$	Gate-Emitter Threshold Voltage	$I_C=400\mu\text{A}, V_{CE}=V_{GE},$ $T_j=25^\circ\text{C}$	5.0	6.0	7.5	V
$V_{CE(sat)}$	Collector to Emitter Saturation Voltage	$I_C=10\text{A}, V_{GE}=15\text{V},$ $T_j=25^\circ\text{C}$		2.10	2.55	V
		$I_C=10\text{A}, V_{GE}=15\text{V},$ $T_j=175^\circ\text{C}$		2.70		

Switching Characteristics

Symbol	Parameter	Test Conditions	Min.	Typ.	Max.	Units
$t_{d(on)}$	Turn-On Delay Time	$V_{CC}=600V, I_C=10A,$ $R_G=22\Omega, V_{GE}=\pm 15V,$ $T_j=25^\circ C$		14		ns
t_r	Rise Time			24		ns
$t_{d(off)}$	Turn-Off Delay Time			110		ns
t_f	Fall Time			38		ns
E_{on}	Turn-On Switching Loss			0.53		mJ
E_{off}	Turn-Off Switching Loss			0.38		mJ
$t_{d(on)}$	Turn-On Delay Time	$V_{CC}=600V, I_C=10A,$ $R_G=22\Omega, V_{GE}=\pm 15V,$ $T_j=175^\circ C$		15		ns
t_r	Rise Time			25		ns
$t_{d(off)}$	Turn-Off Delay Time			130		ns
t_f	Fall Time			270		ns
E_{on}	Turn-On Switching Loss			0.85		mJ
E_{off}	Turn-Off Switching Loss			0.75		mJ
C_{ies}	Input Capacitance	$V_{CE}=30V, f=1Mhz,$ $V_{GE}=0V$		1070		pF
C_{oes}	Output Capacitance			63		pF
C_{res}	Reverse Transfer Capacitance			26		pF
Q_G	Gate Charge	$V_{CC}=600V, I_C=10A,$ $V_{GE}=15V$		50		nC
R_{Gint}	Internal Gate Resister			/		Ω
I_{SC}	SC Data	$t_p \leq 10\mu s, V_{GE}=15V,$ $T_j=125^\circ C, V_{CC}=900V,$ $V_{CEM} \leq 1200V$		90		A

Diode-brake-chopper $T_C=25^\circ C$ unless otherwise noted

Maximum Rated Values

Symbol	Description	GD10PJK120F3S	Units
V_{RRM}	Repetitive Peak Reverse Voltage @ $T_j=25^\circ C$	1200	V
I_F	DC Forward Current	10	A
I_{FRM}	Repetitive Peak Forward Current $t_p=1ms$	20	A

Characteristics Values

Symbol	Parameter	Test Conditions	Min.	Typ.	Max.	Units
V_F	Diode Forward Voltage	$I_F=10A, V_{GE}=0V$	$T_j=25^\circ C$	1.85	2.30	V
			$T_j=125^\circ C$	2.05		
Q_r	Recovered Charge	$I_F=10A,$	$T_j=25^\circ C$	0.98		μC
			$T_j=125^\circ C$	1.51		
I_{RM}	Peak Reverse Recovery Current	$V_R=600V,$ $R_G=100\Omega,$	$T_j=25^\circ C$	6.6		A
			$T_j=125^\circ C$	8.0		
E_{rec}	Reverse Recovery Energy	$V_{GE}=-15V$	$T_j=25^\circ C$	0.36		mJ
			$T_j=125^\circ C$	0.53		

NTC $T_C=25^\circ\text{C}$ unless otherwise noted

Symbol	Parameter	Test Conditions	Min.	Typ.	Max.	Units
R_{25}	Rated Resistance			22.0		$\text{k}\Omega$
$\Delta R/R$	Deviation of R_{100}	$T_C=100^\circ\text{C}, R_{100}=1486.1\Omega$	-5		5	%
P_{25}	Power Dissipation				200	mW
$B_{25/50}$	B-value	$R_2=R_{25}\exp[B_{25/50}(1/T_2-1/(298.15\text{K}))]$		4000		K

IGBT Module

Symbol	Parameter	Min.	Typ.	Max.	Units
V_{ISO}	Isolation Voltage RMS, $f=50\text{Hz}, t=1\text{min}$	4000			V
$R_{\theta\text{JC}}$	Junction-to-Case (per IGBT-inverter)			1.326	K/W
	Junction-to-Case (per Diode-inverter)			2.258	
	Junction-to-Case (per Diode-rectifier)			1.611	
	Junction-to-Case (per IGBT-brake-chopper)			1.588	
	Junction-to-Case (per Diode-brake-chopper)			2.434	
$R_{\theta\text{CS}}$	Case-to-Sink (Conductive grease applied)		0.036		K/W
T_{jmax}	Maximum Junction Temperature			150	$^\circ\text{C}$
T_{jop}	Operating Junction Temperature	-40		125	$^\circ\text{C}$
T_{STG}	Storage Temperature Range	-40		125	$^\circ\text{C}$

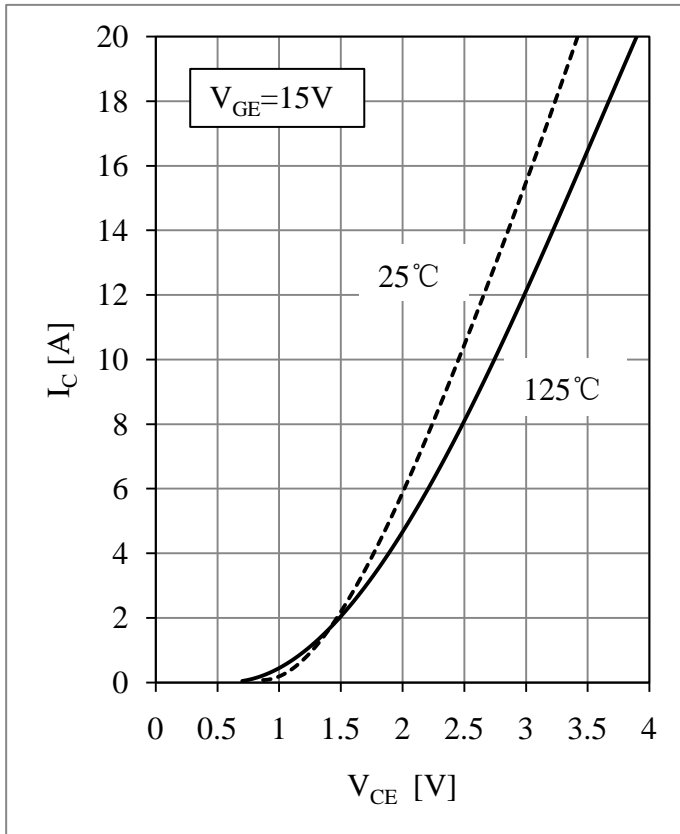

Fig 1. IGBT-inverter Output Characteristics

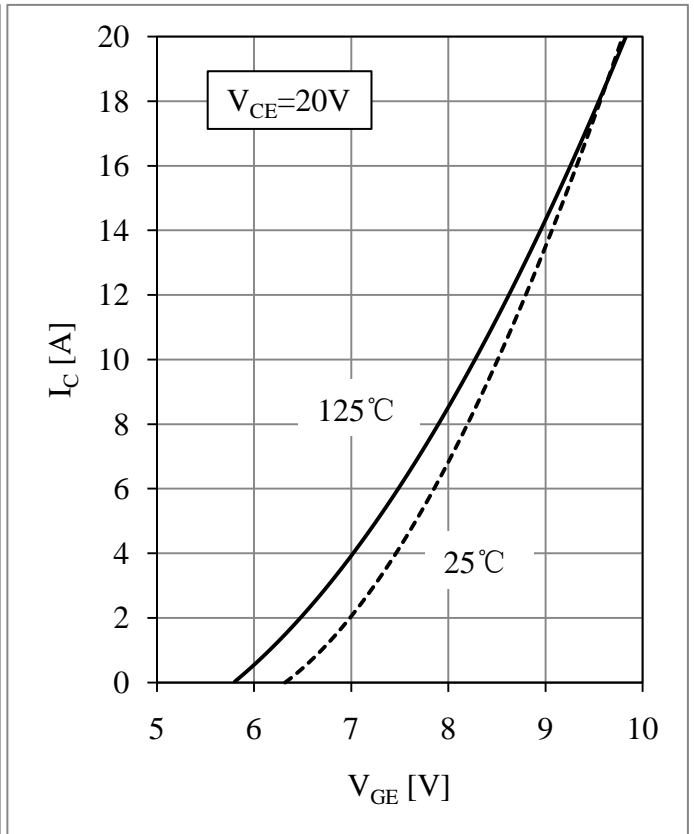

Fig 2. IGBT-inverter Transfer Characteristics

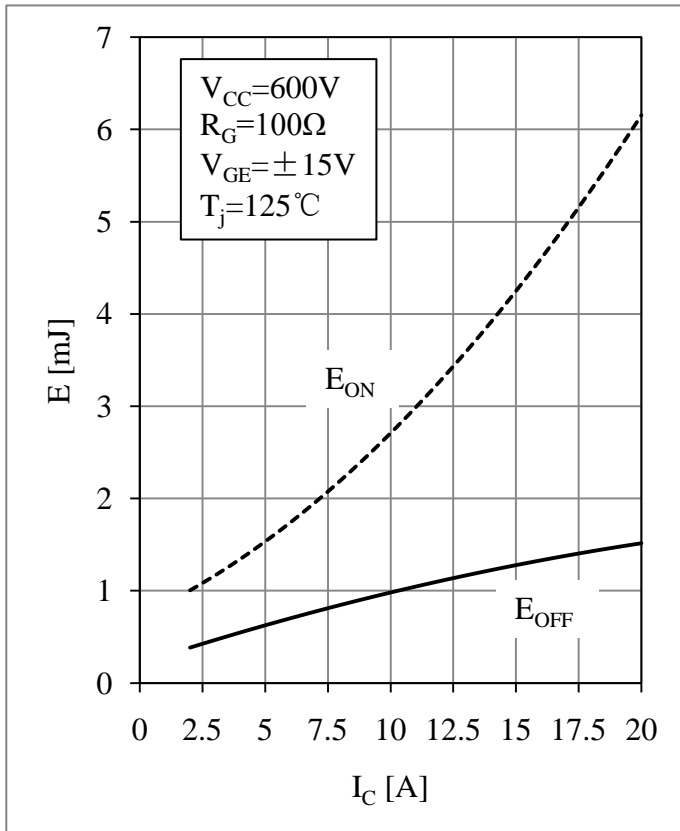

Fig 3. IGBT-inverter Switching Loss vs. I_C

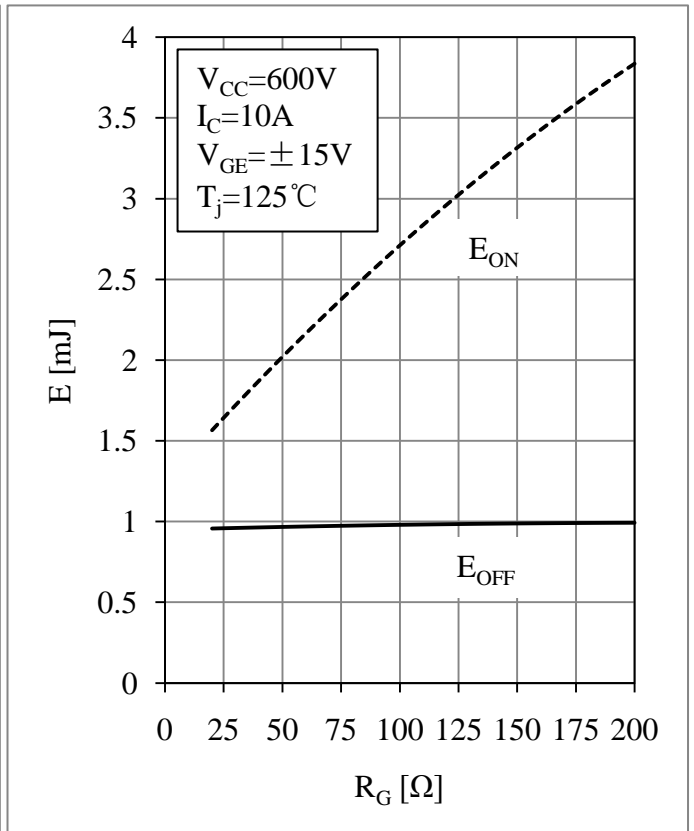

Fig 4. IGBT-inverter Switching Loss vs. R_G

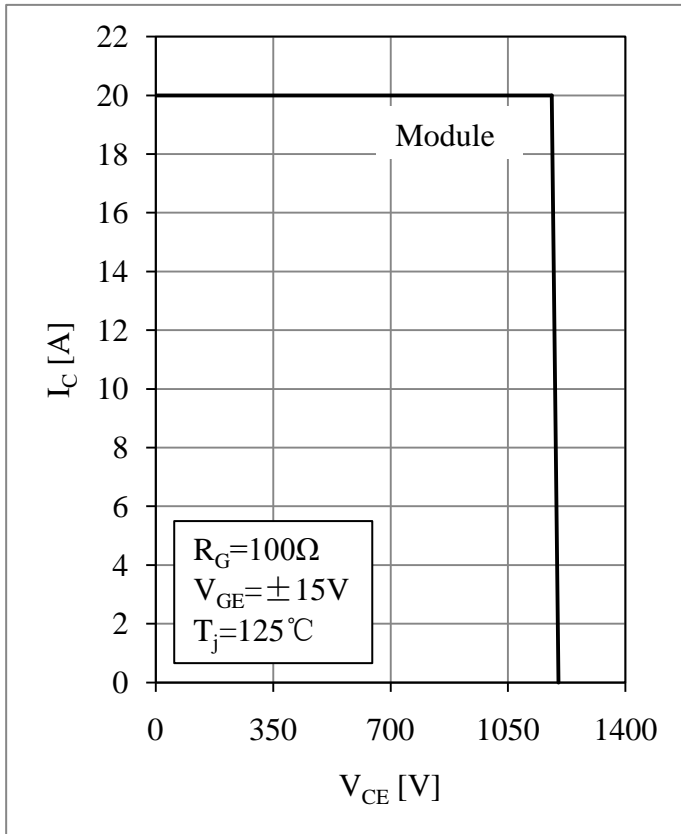

Fig 5. IGBT-inverter RBSOA

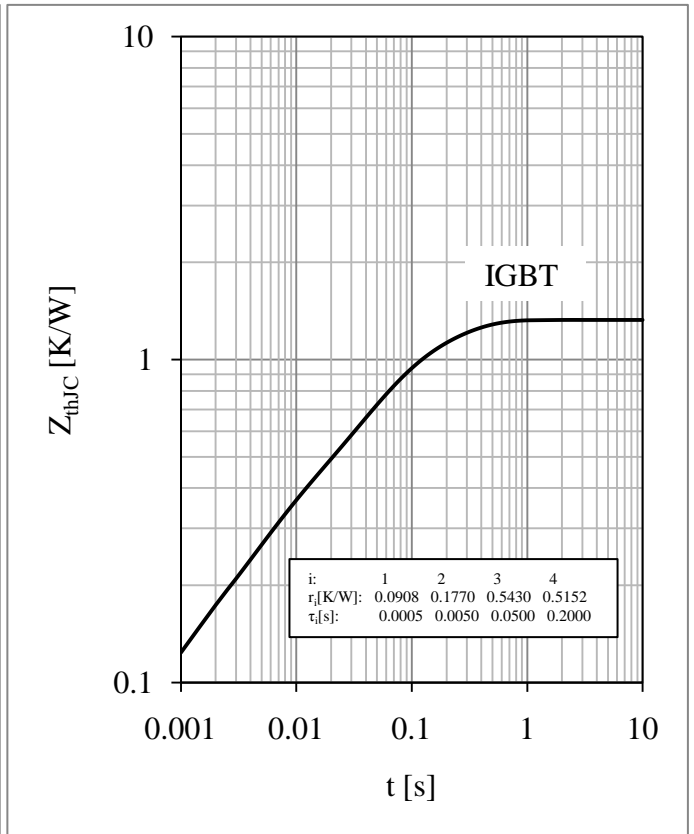

Fig 6. IGBT-inverter Transient Thermal Impedance

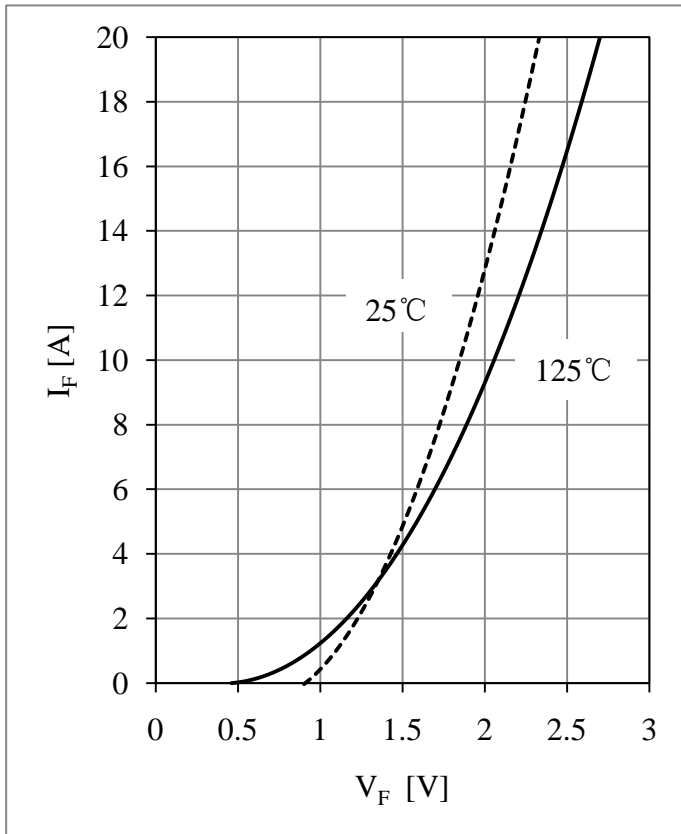

Fig 7. Diode-inverter Forward Characteristics

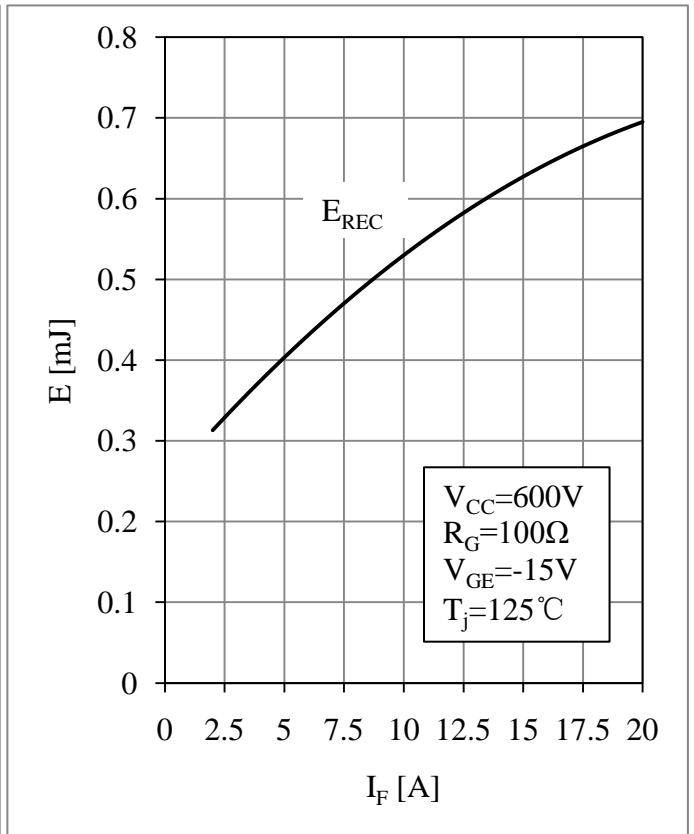

Fig 8. Diode-inverter Switching Loss vs. I_F

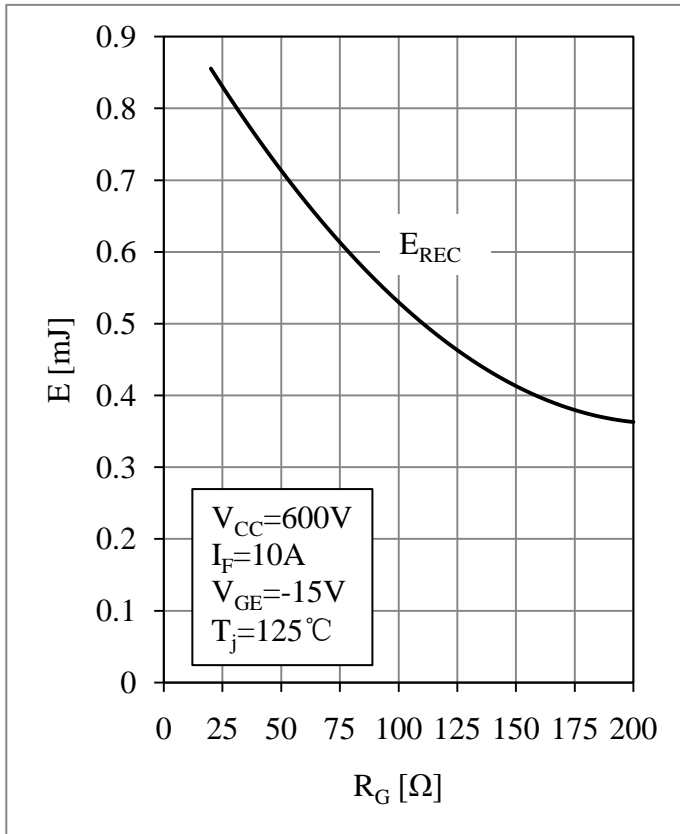

Fig 9. Diode-inverter Switching Loss vs. R_G

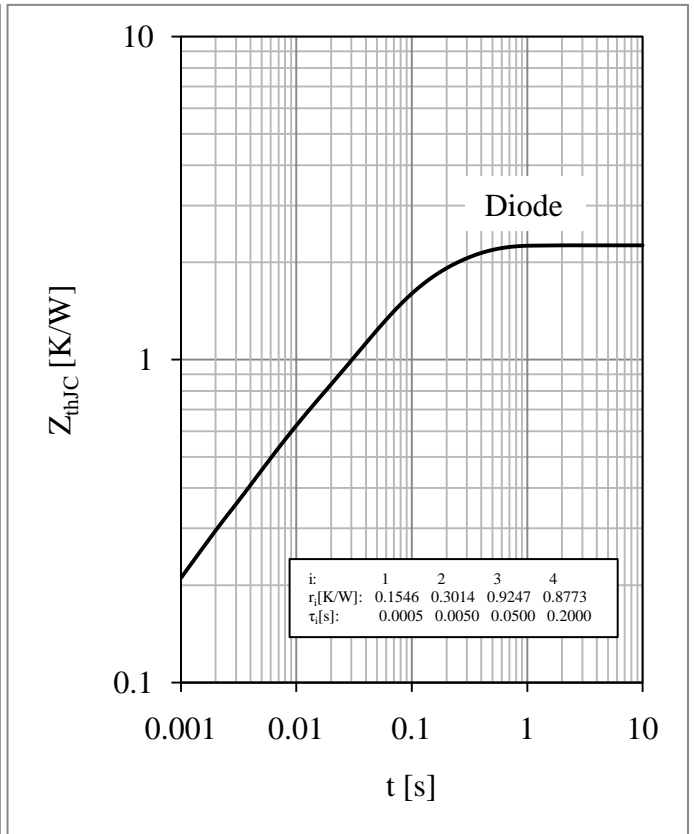

Fig 10. Diode-inverter Transient Thermal Impedance

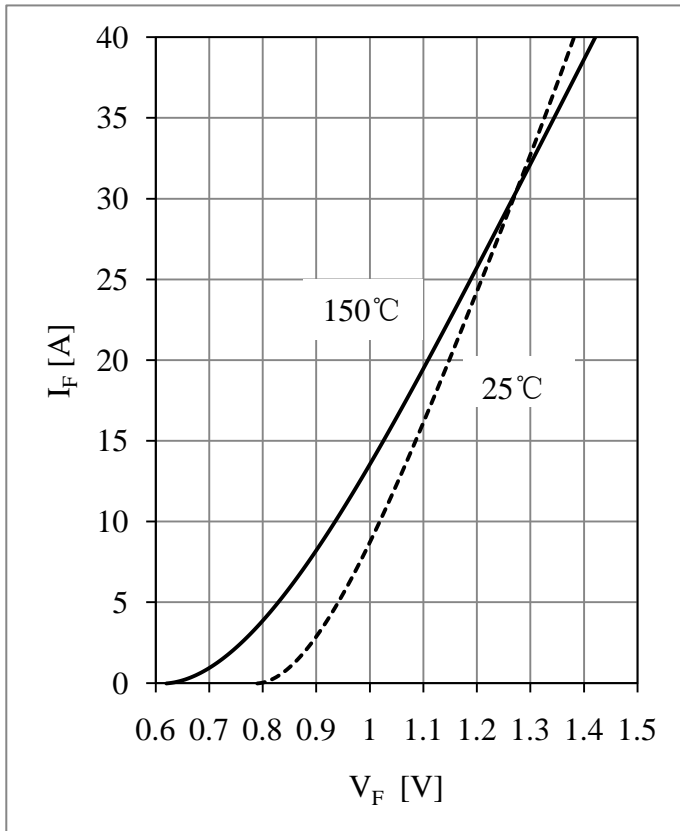

Fig 11. Diode-rectifier Forward Characteristics

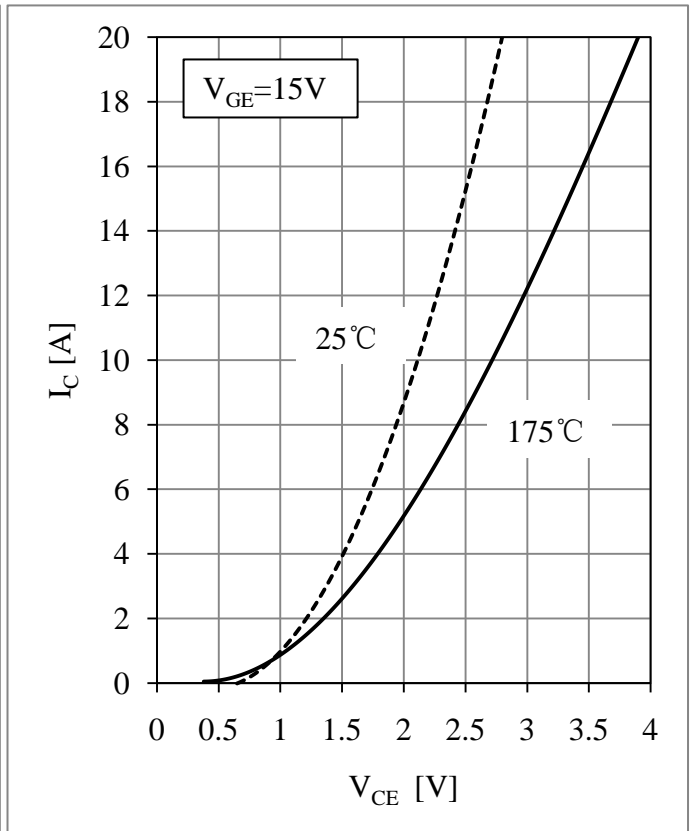

Fig 12. IGBT-brake-chopper Output Characteristics

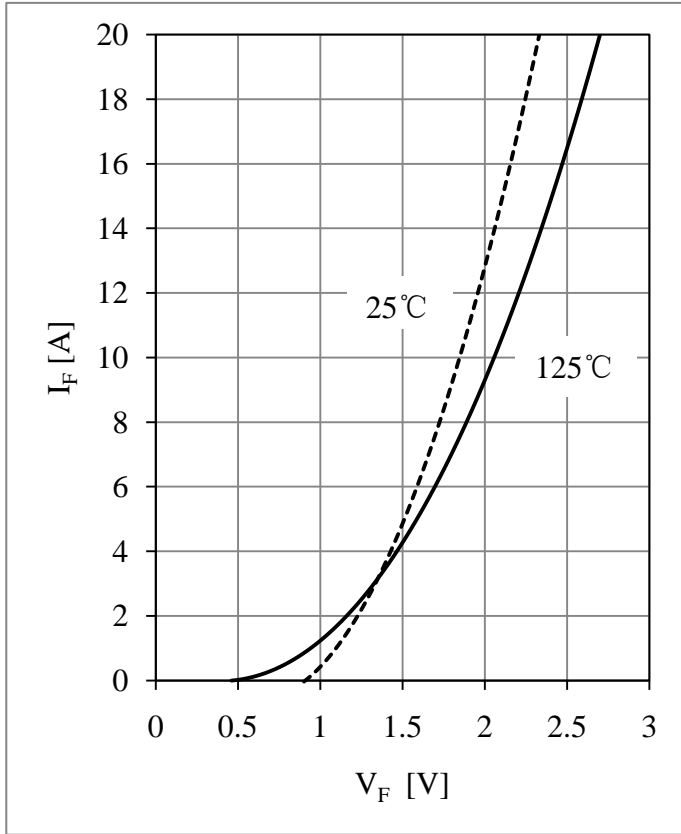

Fig 13. Diode-brake-chopper Forward Characteristics

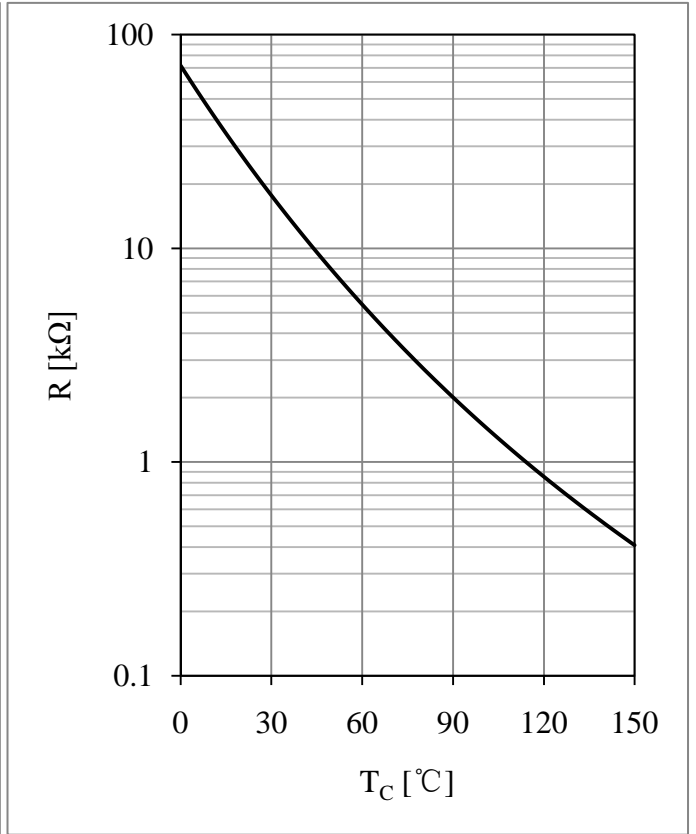
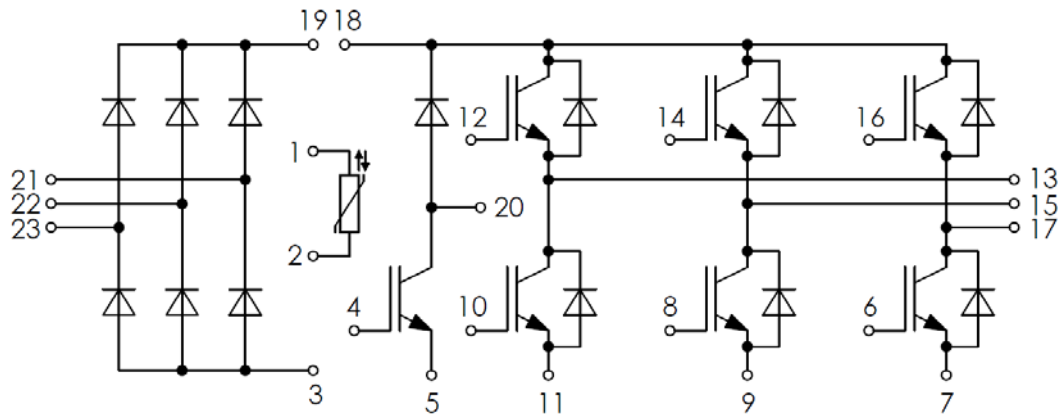

Fig 14. NTC Temperature Characteristic

Equivalent Circuit Schematic



Package Dimensions

Dimensions in Millimeters

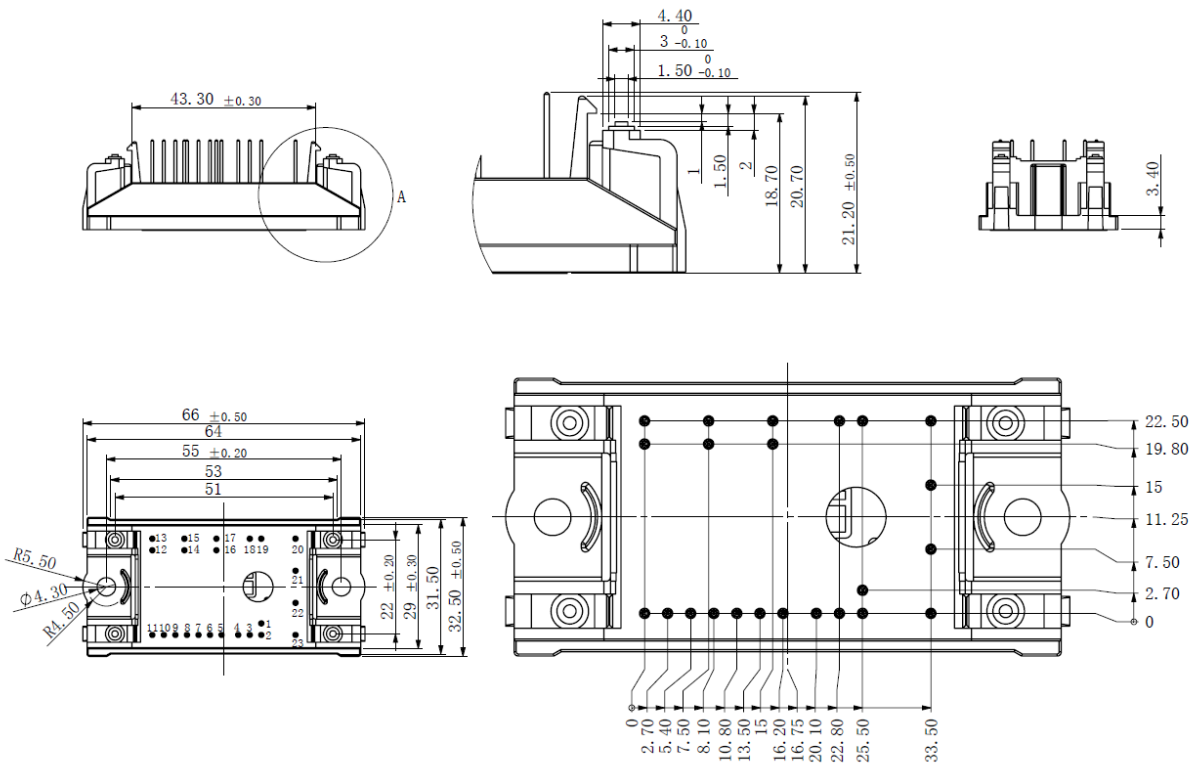

Terms and Conditions of Usage

The data contained in this product datasheet is exclusively intended for technically trained staff. you and your technical departments will have to evaluate the suitability of the product for the intended application and the completeness of the product data with respect to such application.

This product data sheet is describing the characteristics of this product for which a warranty is granted. Any such warranty is granted exclusively pursuant the terms and conditions of the supply agreement. There will be no guarantee of any kind for the product and its characteristics.

Should you require product information in excess of the data given in this product data sheet or which concerns the specific application of our product, please contact the sales office, which is responsible for you (see www.powersemi.cc), For those that are specifically interested we may provide application notes.

Due to technical requirements our product may contain dangerous substances. For information on the types in question please contact the sales office, which is responsible for you.

Should you intend to use the Product in aviation applications, in health or live endangering or life support applications, please notify.

If and to the extent necessary, please forward equivalent notices to your customers.
Changes of this product data sheet are reserved.