

# STARPOWER

SEMICONDUCTOR

IGBT

## GD100MLL120C2S

1200V/100A 3-level in one-package

### General Description

STARPOWER IGBT Power Module provides ultra low conduction loss as well as short circuit ruggedness.

They are designed for the applications such as UPS.

### Features

- Low  $V_{CE(sat)}$  SPT+ IGBT technology
- $V_{CE(sat)}$  with positive temperature coefficient
- Low switching loss
- Maximum junction temperature 175 °C
- Low inductance case
- Fast & soft reverse recovery anti-parallel FWD
- Isolated copper baseplate using DBC technology



### Typical Applications

- Inverter for motor drive
- Uninterruptible power supply
- Solar power

### Equivalent Circuit Schematic

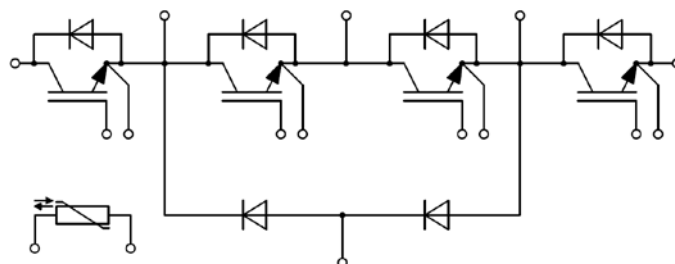

**Absolute Maximum Ratings**  $T_C=25^{\circ}\text{C}$  unless otherwise noted**T1-T4 IGBT**

Symbol	Description	Values	Unit
$V_{CES}$	Collector-Emitter Voltage	1200	V
$V_{GES}$	Gate-Emitter Voltage	$\pm 20$	V
$I_C$	Collector Current @ $T_C=25^{\circ}\text{C}$	190	A
	@ $T_C=100^{\circ}\text{C}$	100	
$I_{CM}$	Pulsed Collector Current $t_p=1\text{ms}$	200	A
$P_D$	Maximum Power Dissipation @ $T_j=175^{\circ}\text{C}$	718	W

**D1-D4 Diode**

Symbol	Description	Values	Unit
$V_{RRM}$	Repetitive Peak Reverse Voltage	1200	V
$I_F$	Diode Continuous Forward Current	100	A
$I_{FM}$	Diode Maximum Forward Current $t_p=1\text{ms}$	200	A

**D5,D6 Diode**

Symbol	Description	Values	Unit
$V_{RRM}$	Repetitive Peak Reverse Voltage	1200	V
$I_F$	Diode Continuous Forward Current	100	A
$I_{FM}$	Diode Maximum Forward Current $t_p=1\text{ms}$	200	A

**Module**

Symbol	Description	Values	Unit
$T_{jmax}$	Maximum Junction Temperature	175	$^{\circ}\text{C}$
$T_{jop}$	Operating Junction Temperature	-40 to +150	$^{\circ}\text{C}$
$T_{STG}$	Storage Temperature Range	-40 to +125	$^{\circ}\text{C}$
$V_{ISO}$	Isolation Voltage RMS, $f=50\text{Hz}$ , $t=1\text{min}$	4000	V
M	Terminal Connection Torque, Screw M6	2.5 to 5.0	N.m
	Mounting Torque, Screw M6	3.0 to 5.0	

**T1-T4 IGBT Characteristics**  $T_C=25^\circ\text{C}$  unless otherwise noted

Symbol	Parameter	Test Conditions	Min.	Typ.	Max.	Unit
$V_{CE(sat)}$	Collector to Emitter Saturation Voltage	$I_C=100\text{A}, V_{GE}=15\text{V}, T_j=25^\circ\text{C}$		1.90	2.35	V
		$I_C=100\text{A}, V_{GE}=15\text{V}, T_j=125^\circ\text{C}$		2.10		
		$I_C=100\text{A}, V_{GE}=15\text{V}, T_j=150^\circ\text{C}$		2.20		
$V_{GE(th)}$	Gate-Emitter Threshold Voltage	$I_C=4.0\text{mA}, V_{CE}=V_{GE}, T_j=25^\circ\text{C}$	5.0	6.2	7.0	V
$I_{CES}$	Collector Cut-Off Current	$V_{CE}=V_{CES}, V_{GE}=0\text{V}, T_j=25^\circ\text{C}$			1.0	mA
$I_{GES}$	Gate-Emitter Leakage Current	$V_{GE}=V_{GES}, V_{CE}=0\text{V}, T_j=25^\circ\text{C}$			400	nA
$R_{Gint}$	Internal Gate Resistance			2.0		$\Omega$
$C_{ies}$	Input Capacitance	$V_{CE}=25\text{V}, f=1\text{MHz}, V_{GE}=0\text{V}$		7.43		nF
$C_{res}$	Reverse Transfer Capacitance				0.34	
$Q_G$	Gate Charge	$V_{GE}=-15 \dots +15\text{V}$		1.12		$\mu\text{C}$
$t_{d(on)}$	Turn-On Delay Time	$V_{CC}=600\text{V}, I_C=100\text{A}, R_G=5.6\Omega, V_{GE}=\pm 15\text{V}, T_j=25^\circ\text{C}$		279		ns
$t_r$	Rise Time			61		ns
$t_{d(off)}$	Turn-Off Delay Time			308		ns
$t_f$	Fall Time			205		ns
$E_{on}$	Turn-On Switching Loss			5.56		mJ
$E_{off}$	Turn-Off Switching Loss			6.95		mJ
$t_{d(on)}$	Turn-On Delay Time	$V_{CC}=600\text{V}, I_C=100\text{A}, R_G=5.6\Omega, V_{GE}=\pm 15\text{V}, T_j=125^\circ\text{C}$		287		ns
$t_r$	Rise Time			63		ns
$t_{d(off)}$	Turn-Off Delay Time			328		ns
$t_f$	Fall Time			360		ns
$E_{on}$	Turn-On Switching Loss			7.85		mJ
$E_{off}$	Turn-Off Switching Loss			10.6		mJ
$t_{d(on)}$	Turn-On Delay Time	$V_{CC}=600\text{V}, I_C=100\text{A}, R_G=5.6\Omega, V_{GE}=\pm 15\text{V}, T_j=150^\circ\text{C}$		295		ns
$t_r$	Rise Time			65		ns
$t_{d(off)}$	Turn-Off Delay Time			350		ns
$t_f$	Fall Time			380		ns
$E_{on}$	Turn-On Switching Loss			8.65		mJ
$E_{off}$	Turn-Off Switching Loss			12.0		mJ
$I_{SC}$	SC Data	$t_p \leq 10\mu\text{s}, V_{GE}=15\text{V}, T_j=150^\circ\text{C}, V_{CC}=900\text{V}, V_{CEM} \leq 1200\text{V}$		470		A

**D1-D4 Diode Characteristics**  $T_c=25^\circ\text{C}$  unless otherwise noted

Symbol	Parameter	Test Conditions	Min.	Typ.	Max.	Units
$V_F$	Diode Forward Voltage	$I_C=100\text{A}, V_{GE}=0\text{V}, T_j=25^\circ\text{C}$		1.80	2.25	V
		$I_C=100\text{A}, V_{GE}=0\text{V}, T_j=125^\circ\text{C}$		1.85		
		$I_C=100\text{A}, V_{GE}=0\text{V}, T_j=150^\circ\text{C}$		1.85		
$Q_r$	Recovered Charge	$V_R=600\text{V}, I_F=100\text{A}, R_G=5.6\Omega, V_{GE}=-15\text{V}, T_j=25^\circ\text{C}$		6.2		$\mu\text{C}$
$I_{RM}$	Peak Reverse Recovery Current			92		A
$E_{rec}$	Reverse Recovery Energy			3.74		mJ
$Q_r$	Recovered Charge	$V_R=600\text{V}, I_F=100\text{A}, R_G=5.6\Omega, V_{GE}=-15\text{V}, T_j=125^\circ\text{C}$		11.8		$\mu\text{C}$
$I_{RM}$	Peak Reverse Recovery Current			124		A
$E_{rec}$	Reverse Recovery Energy			6.45		mJ
$Q_r$	Recovered Charge	$V_R=600\text{V}, I_F=100\text{A}, R_G=5.6\Omega, V_{GE}=-15\text{V}, T_j=150^\circ\text{C}$		14.2		$\mu\text{C}$
$I_{RM}$	Peak Reverse Recovery Current			130		A
$E_{rec}$	Reverse Recovery Energy			8.05		mJ

**D5,D6 Diode Characteristics**  $T_C=25^\circ\text{C}$  unless otherwise noted

Symbol	Parameter	Test Conditions	Min.	Typ.	Max.	Units
$V_F$	Diode Forward Voltage	$I_C=100\text{A}, V_{GE}=0\text{V}, T_j=25^\circ\text{C}$		1.80	2.25	V
		$I_C=100\text{A}, V_{GE}=0\text{V}, T_j=125^\circ\text{C}$		1.85		
		$I_C=100\text{A}, V_{GE}=0\text{V}, T_j=150^\circ\text{C}$		1.85		
$Q_r$	Recovered Charge	$V_R=600\text{V}, I_F=100\text{A}, R_G=5.6\Omega, V_{GE}=-15\text{V}, T_j=25^\circ\text{C}$		6.2		$\mu\text{C}$
$I_{RM}$	Peak Reverse Recovery Current			92		A
$E_{rec}$	Reverse Recovery Energy			3.74		mJ
$Q_r$	Recovered Charge	$V_R=600\text{V}, I_F=100\text{A}, R_G=5.6\Omega, V_{GE}=-15\text{V}, T_j=125^\circ\text{C}$		11.8		$\mu\text{C}$
$I_{RM}$	Peak Reverse Recovery Current			124		A
$E_{rec}$	Reverse Recovery Energy			6.45		mJ
$Q_r$	Recovered Charge	$V_R=600\text{V}, I_F=100\text{A}, R_G=5.6\Omega, V_{GE}=-15\text{V}, T_j=150^\circ\text{C}$		14.2		$\mu\text{C}$
$I_{RM}$	Peak Reverse Recovery Current			130		A
$E_{rec}$	Reverse Recovery Energy			8.05		mJ

**NTC Characteristics**  $T_C=25^\circ\text{C}$  unless otherwise noted

Symbol	Parameter	Test Conditions	Min.	Typ.	Max.	Units
$R_{25}$	Rated Resistance			5.0		$\text{k}\Omega$
$\Delta R/R$	Deviation of $R_{100}$	$T_C=100^\circ\text{C}, R_{100}=493.3\Omega$	-5		5	%
$P_{25}$	Power Dissipation				20.0	mW
$B_{25/50}$	B-value	$R_2=R_{25}\exp[B_{25/50}(1/T_2-1/(298.15\text{K}))]$		3375		K

**Module Characteristics**  $T_C=25^\circ\text{C}$  unless otherwise noted

Symbol	Parameter	Min.	Typ.	Max.	Unit
$R_{\theta JC}$	Junction-to-Case (per T1-T4 IGBT)			0.209	K/W
	Junction-to-Case (per D1-D4 Diode)			0.366	
	Junction-to-Case (per D5,D6 Diode)			0.366	
$R_{\theta CS}$	Case-to-Sink (per T1-T4 IGBT)		0.260		K/W
	Case-to-Sink (per D1-D4 Diode)		0.455		
	Case-to-Sink (per D5,D6 Diode)		0.455		
$R_{\theta CS}$	Case-to-Sink		0.035		K/W
G	Weight of Module		340		g

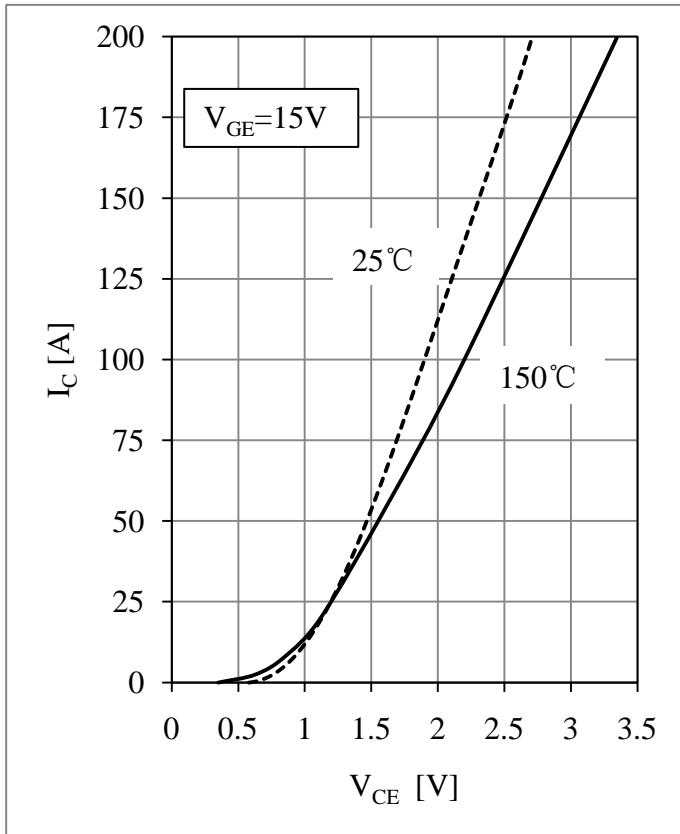

Fig 1. T1-T4 IGBT Output Characteristics

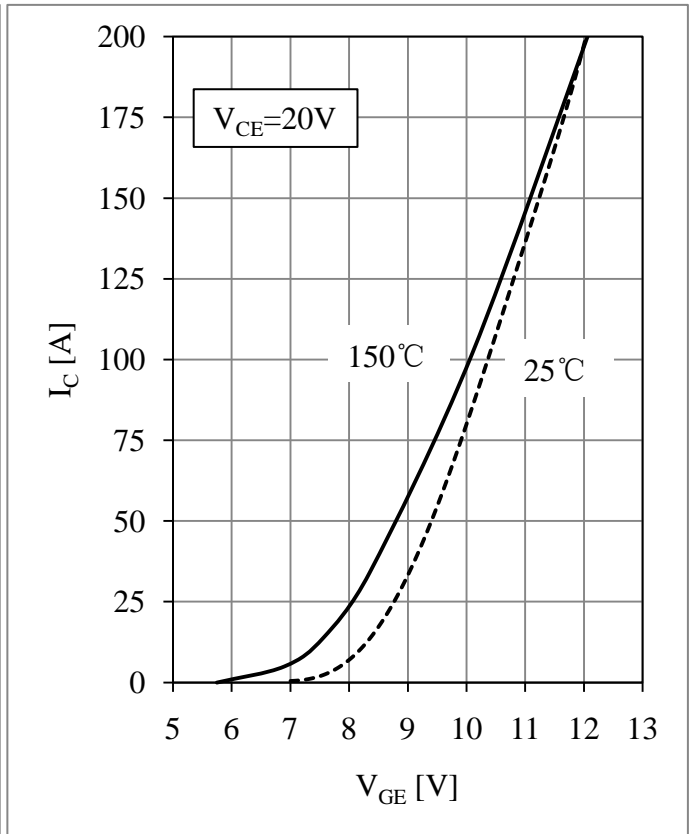

Fig 2. T1-T4 IGBT Transfer Characteristics

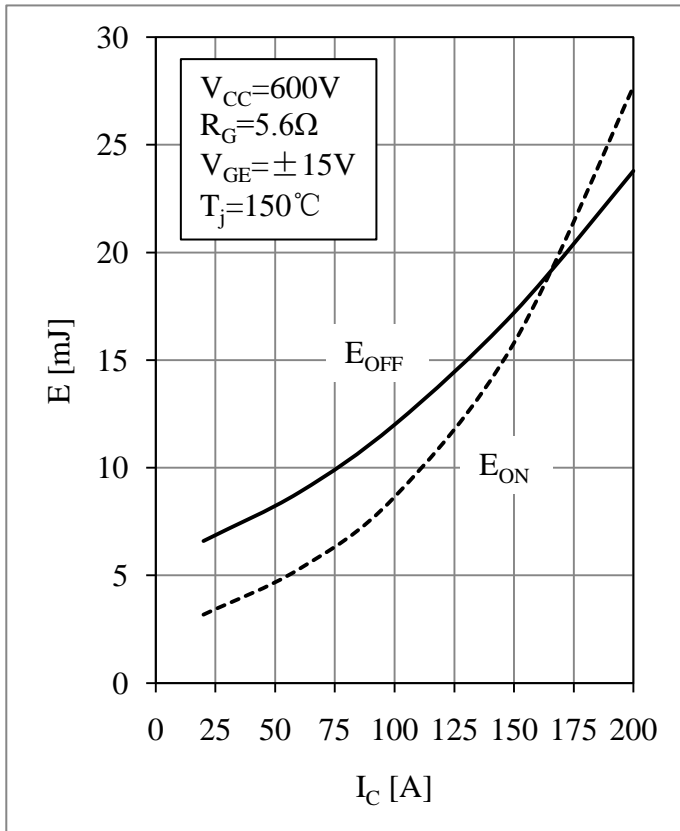

Fig 3. T1-T4 IGBT Switching Loss vs.  $I_C$

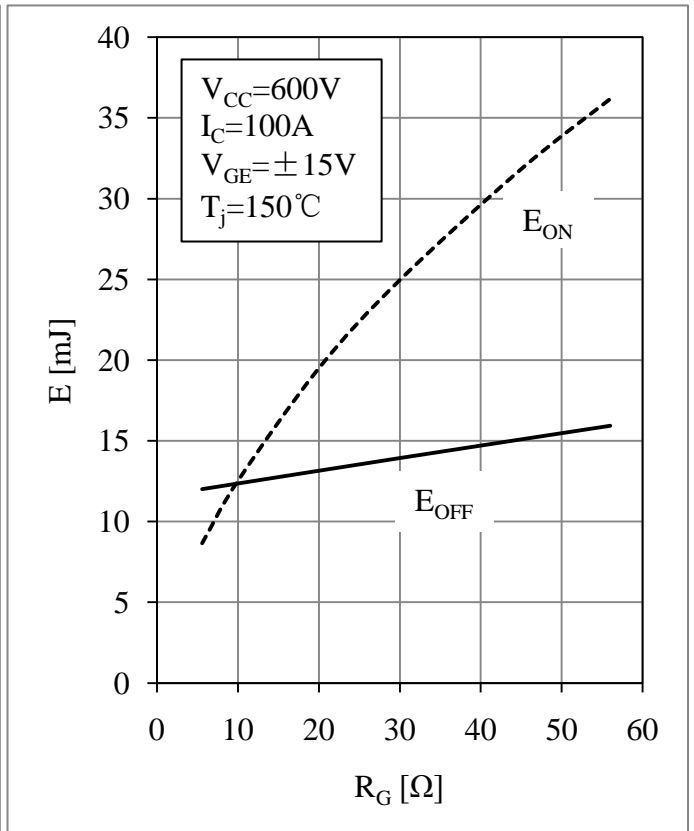

Fig 4. T1-T4 IGBT Switching Loss vs.  $R_G$

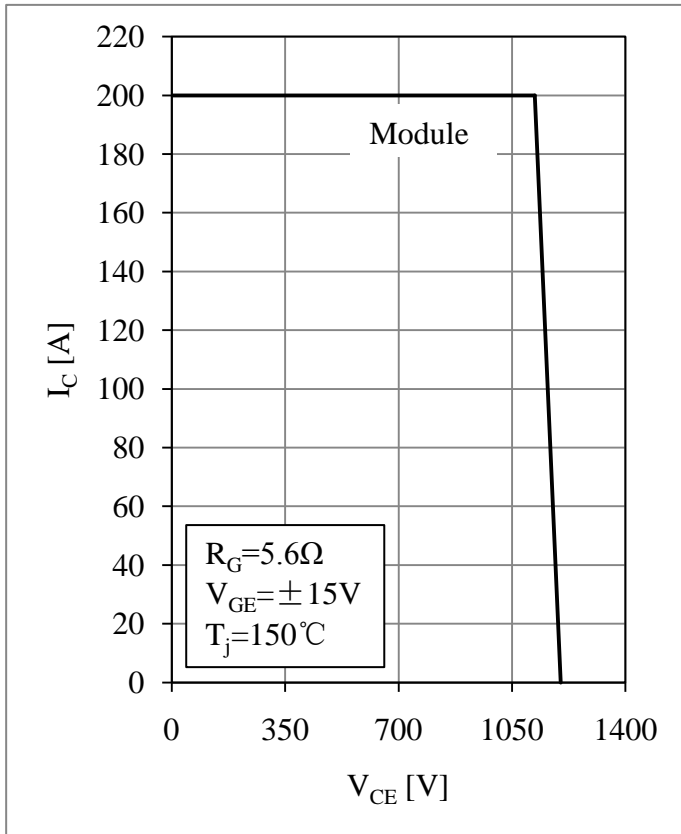

Fig 5. T1-T4 RBSOA

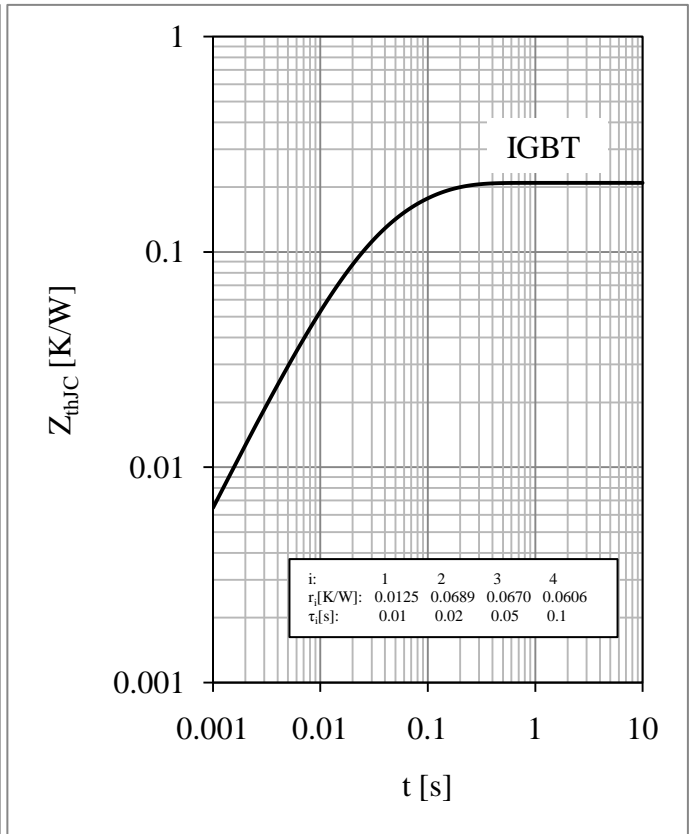

Fig 6. T1-T4 IGBT Transient Thermal Impedance

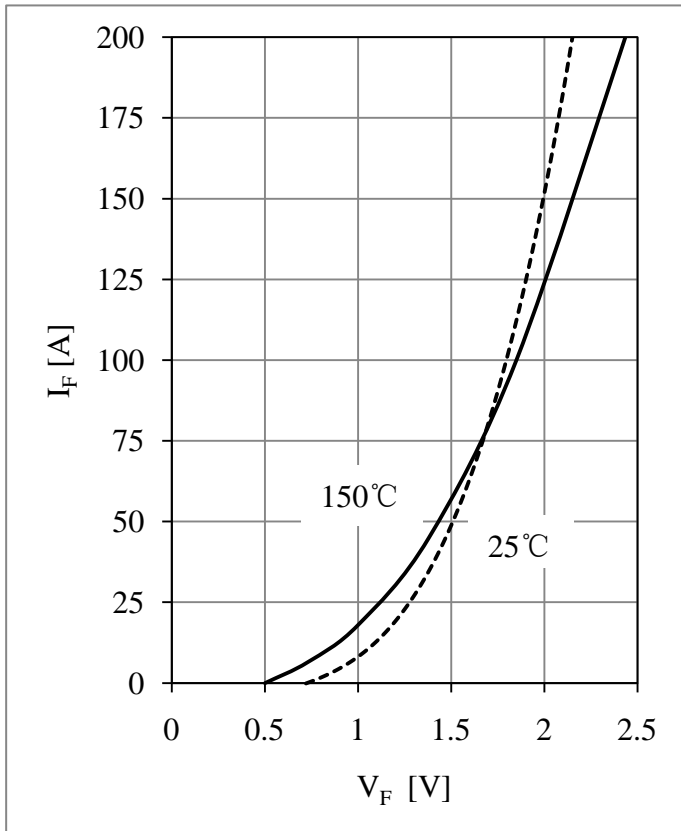

Fig 7. D1-D4 Diode Forward Characteristics

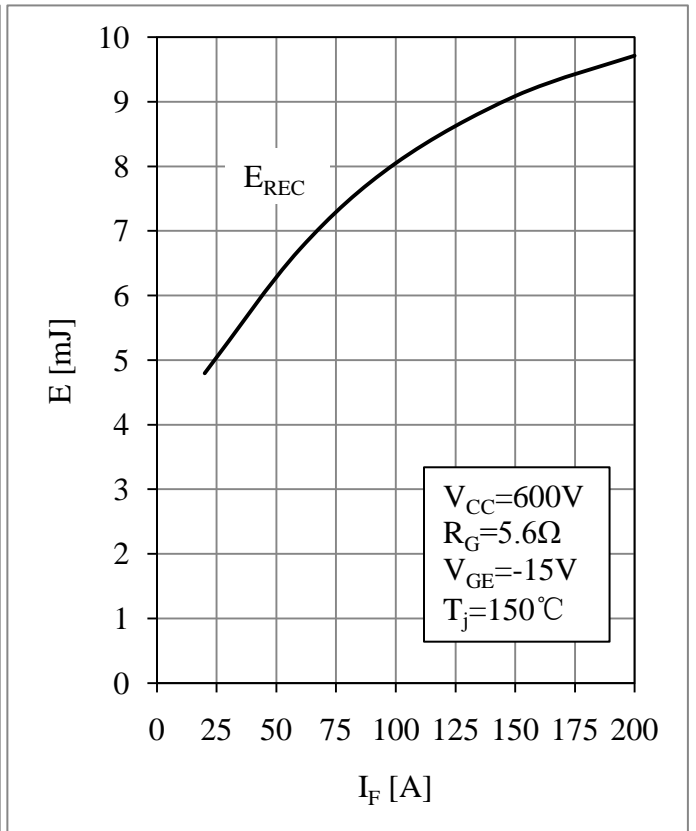

Fig 8. D1-D4 Diode Switching Loss vs.  $I_F$

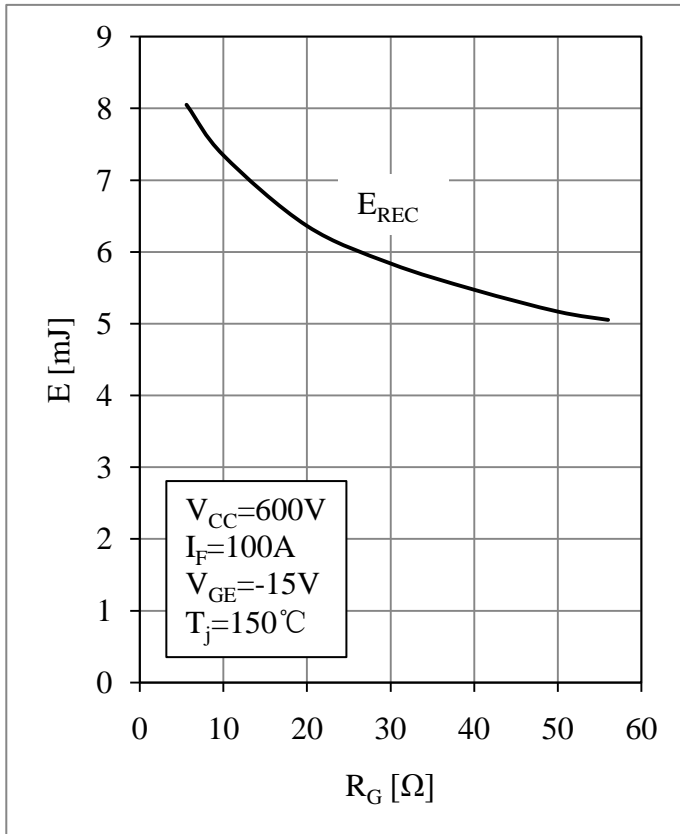

Fig 9. D1-D4 Diode Switching Loss vs.  $R_G$

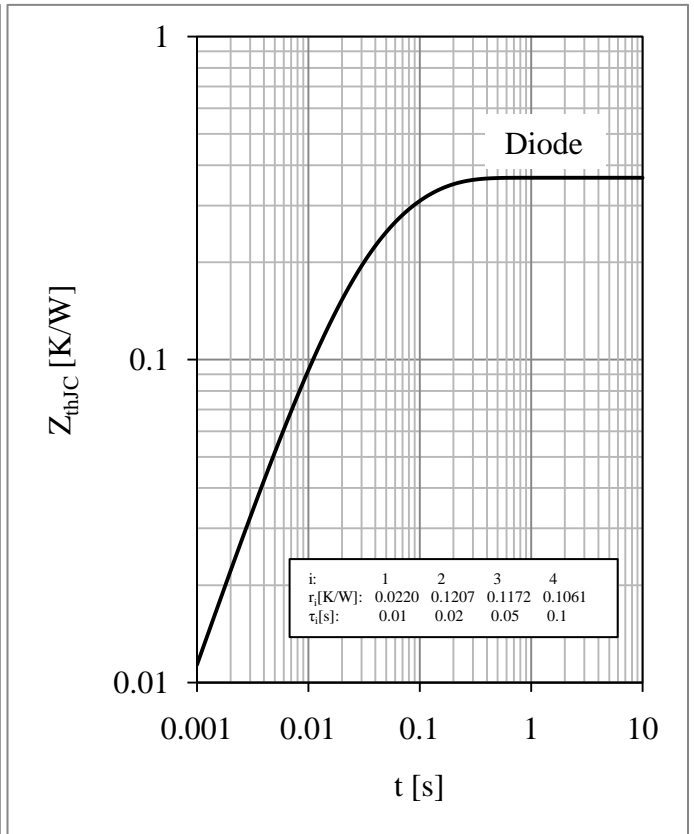

Fig 10. D1-D4 Diode Transient Thermal Impedance

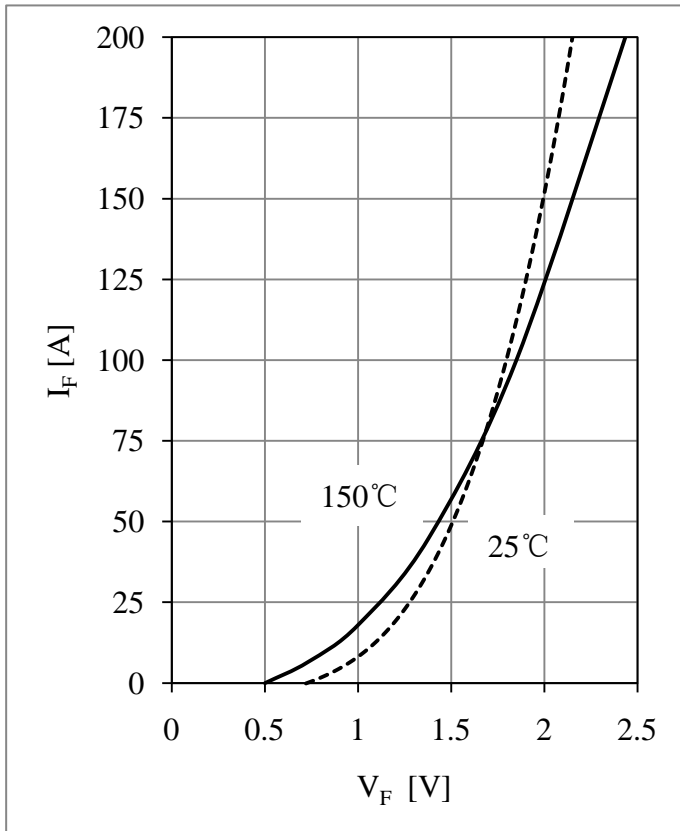

Fig 11. D5,D6 Diode Forward Characteristics

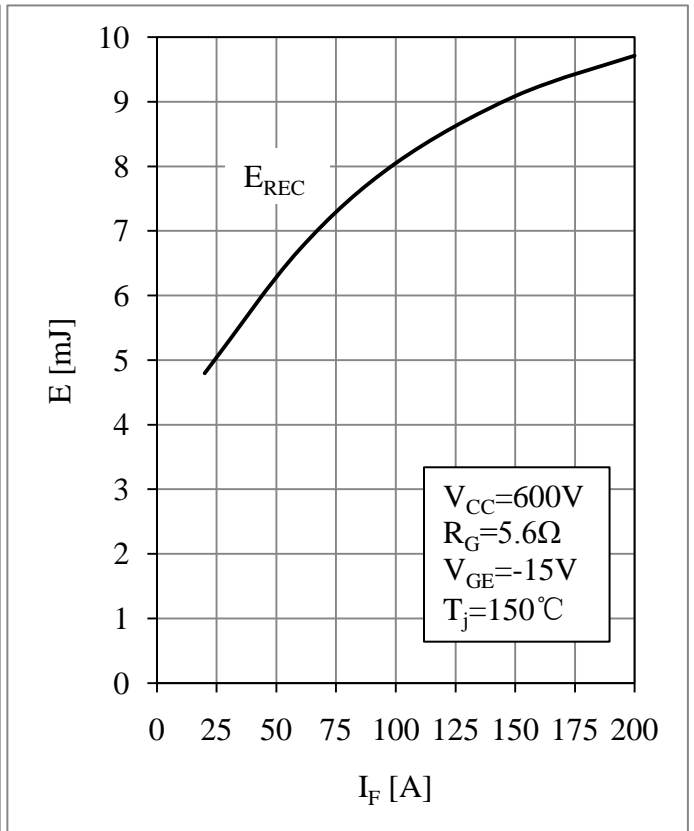

Fig 12. D5,D6 Diode Switching Loss vs.  $I_F$



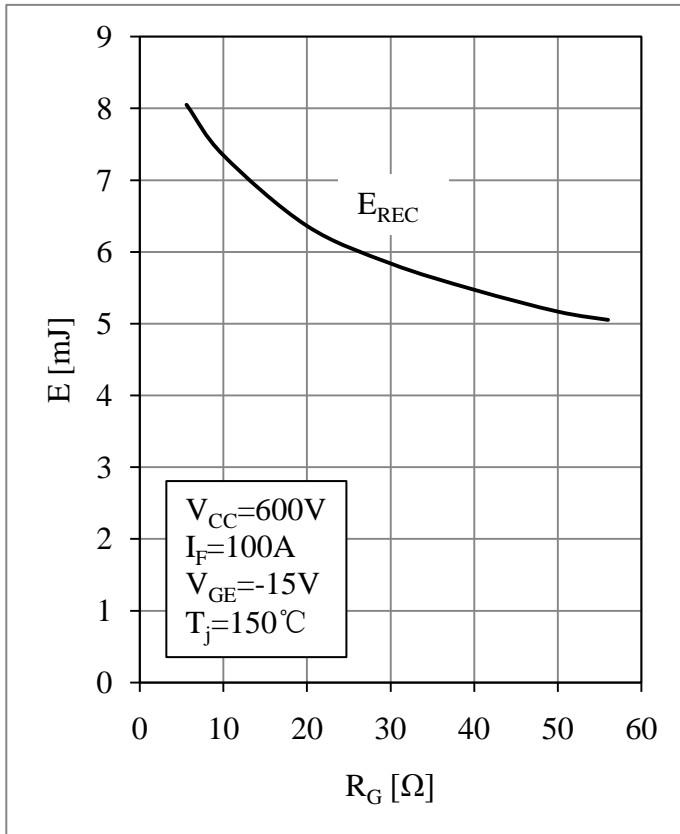

Fig 13. D5,D6 Diode Switching Loss vs.  $R_G$

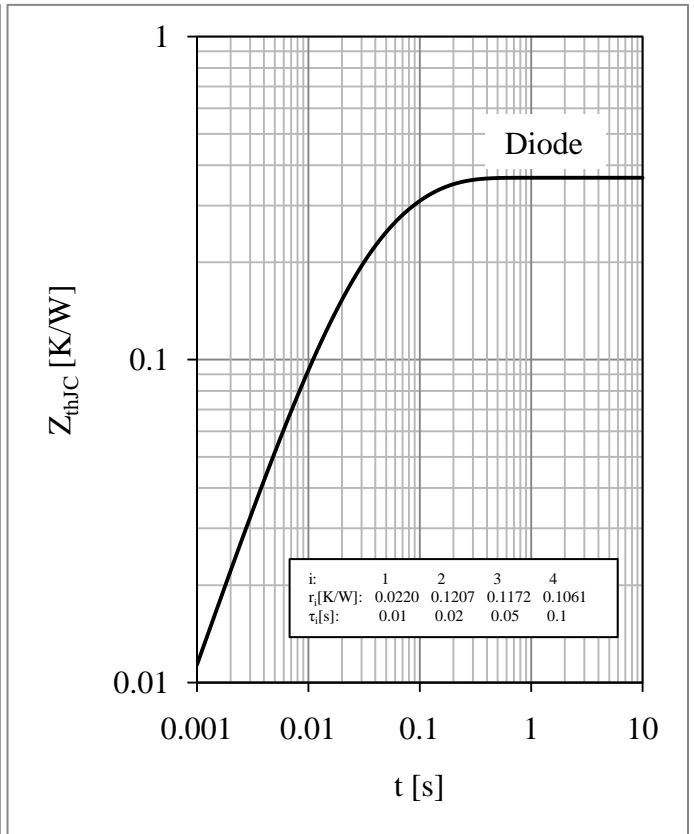

Fig 14. D5,D6 Diode Transient Thermal Impedance

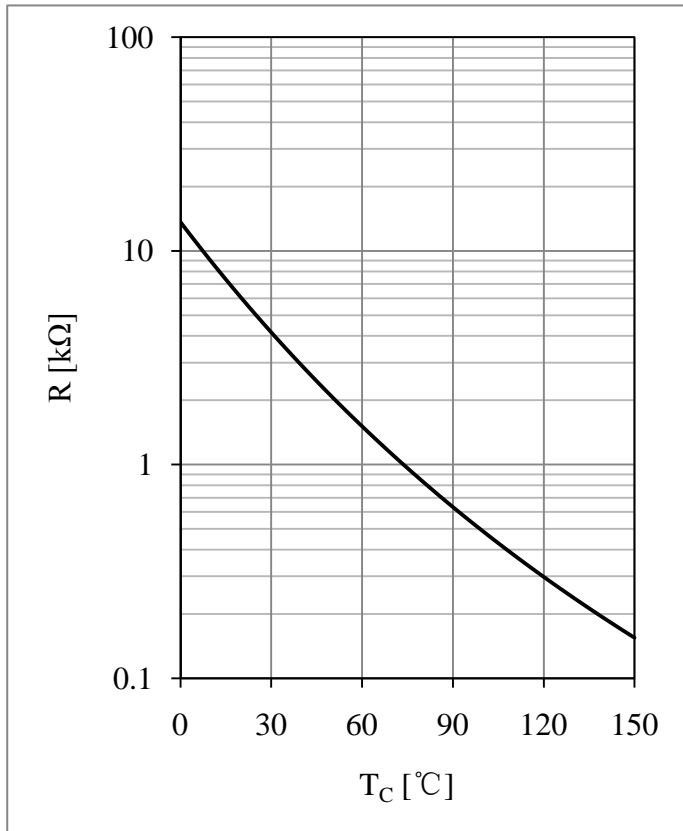
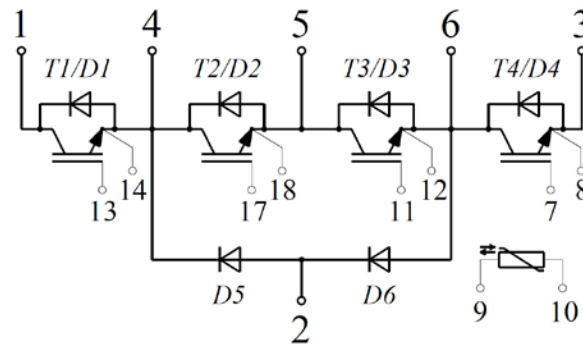

Fig 15. NTC Temperature Characteristic

**Circuit Schematic**



**Package Dimensions**

Dimensions in Millimeters

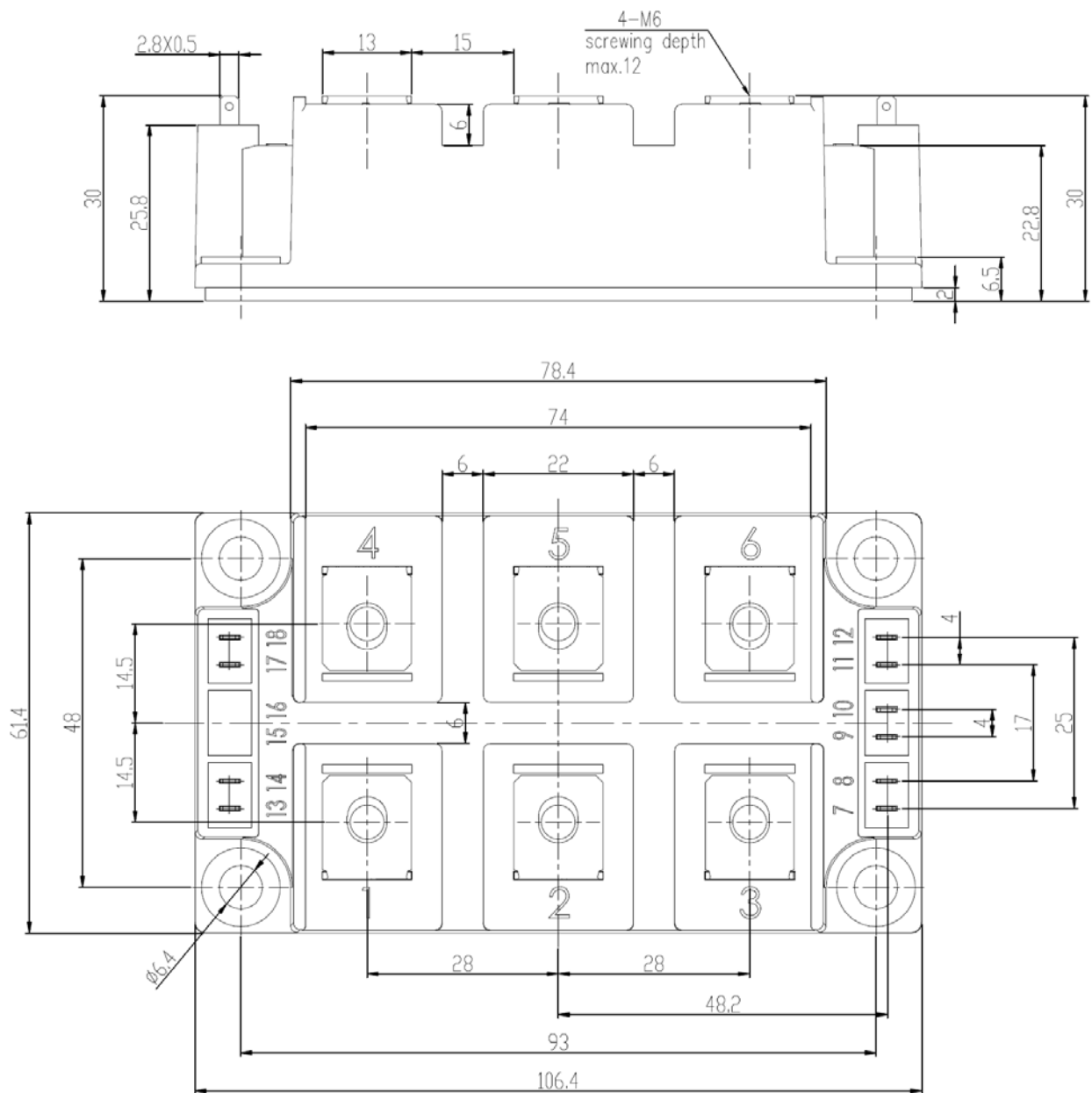

## Terms and Conditions of Usage

The data contained in this product datasheet is exclusively intended for technically trained staff. you and your technical departments will have to evaluate the suitability of the product for the intended application and the completeness of the product data with respect to such application.

This product data sheet is describing the characteristics of this product for which a warranty is granted. Any such warranty is granted exclusively pursuant the terms and conditions of the supply agreement. There will be no guarantee of any kind for the product and its characteristics.

Should you require product information in excess of the data given in this product data sheet or which concerns the specific application of our product, please contact the sales office, which is responsible for you (see [www.powersemi.cc](http://www.powersemi.cc)), For those that are specifically interested we may provide application notes.

Due to technical requirements our product may contain dangerous substances. For information on the types in question please contact the sales office, which is responsible for you.

Should you intend to use the Product in aviation applications, in health or live endangering or life support applications, please notify.

If and to the extent necessary, please forward equivalent notices to your customers.  
Changes of this product data sheet are reserved.