

STARPOWER

SEMICONDUCTOR

IGBT

GD100FFT120C6S

Molding Type Module**1200V/100A 6 in one-package**

General Description

STARPOWER IGBT Power Module provides ultra low conduction loss as well as short circuit ruggedness. They are designed for the applications such as general inverters and UPS.



Features

- Low $V_{CE(sat)}$ Trench IGBT technology
- 10 μ s short circuit capability
- $V_{CE(sat)}$ with positive temperature coefficient
- Maximum junction temperature 175 °C
- Low inductance case
- Fast & soft reverse recovery anti-parallel FWD
- Isolated copper baseplate using DBC technology

Typical Applications

- Inverter for motor drive
- AC and DC servo drive amplifier
- Uninterruptible power supply

Absolute Maximum Ratings $T_C=25^\circ\text{C}$ unless otherwise noted

Symbol	Description	GD100FFT120C6S	Units
V_{CES}	Collector-Emitter Voltage	1200	V
V_{GES}	Gate-Emitter Voltage	± 30	V
I_C	Collector Current @ $T_C=25^\circ\text{C}$	180	A
	@ $T_C=80^\circ\text{C}$	100	
I_{CM}	Pulsed Collector Current $t_p=1\text{ms}$	200	A
I_F	Diode Continuous Forward Current @ $T_C=80^\circ\text{C}$	100	A
I_{FM}	Diode Maximum Forward Current $t_p=1\text{ms}$	200	A
P_D	Maximum Power Dissipation @ $T_j=175^\circ\text{C}$	579	W
T_{jmax}	Maximum Junction Temperature	175	$^\circ\text{C}$
T_{jop}	Operating Junction Temperature	-40 to +150	$^\circ\text{C}$
T_{STG}	Storage Temperature Range	-40 to +125	$^\circ\text{C}$
V_{ISO}	Isolation Voltage RMS, $f=50\text{Hz}, t=1\text{min}$	2500	V
Mounting Torque	Mounting Screw:M5	3.0 to 6.0	N.m

Electrical Characteristics of IGBT $T_C=25^\circ\text{C}$ unless otherwise noted**Off Characteristics**

Symbol	Parameter	Test Conditions	Min.	Typ.	Max.	Units
$V_{(BR)CES}$	Collector-Emitter Breakdown Voltage	$T_j=25^\circ\text{C}$	1200			V
I_{CES}	Collector Cut-Off Current	$V_{CE}=V_{CES}, V_{GE}=0\text{V}, T_j=25^\circ\text{C}$			5.0	mA
I_{GES}	Gate-Emitter Leakage Current	$V_{GE}=V_{GES}, V_{CE}=0\text{V}, T_j=25^\circ\text{C}$			400	nA

On Characteristics

Symbol	Parameter	Test Conditions	Min.	Typ.	Max.	Units
$V_{GE(th)}$	Gate-Emitter Threshold Voltage	$I_C=5.0\text{mA}, V_{CE}=V_{GE}, T_j=25^\circ\text{C}$	5.0	5.7	7.5	V
$V_{CE(sat)}$	Collector to Emitter Saturation Voltage	$I_C=100\text{A}, V_{GE}=15\text{V}, T_j=25^\circ\text{C}$		1.90	2.35	V
		$I_C=100\text{A}, V_{GE}=15\text{V}, T_j=175^\circ\text{C}$		2.50		

Switching Characteristics

Symbol	Parameter	Test Conditions	Min.	Typ.	Max.	Units
$t_{d(on)}$	Turn-On Delay Time	$V_{CC}=600V, I_C=100A,$ $R_G=5.1\Omega, V_{GE}=\pm 15V,$ $T_j=25^\circ C$		257		ns
t_r	Rise Time			54		ns
$t_{d(off)}$	Turn-Off Delay Time			261		ns
t_f	Fall Time			176		ns
E_{on}	Turn-On Switching Loss			2.60		mJ
E_{off}	Turn-Off Switching Loss			3.67		mJ
$t_{d(on)}$	Turn-On Delay Time	$V_{CC}=600V, I_C=100A,$ $R_G=5.1\Omega, V_{GE}=\pm 15V,$ $T_j=125^\circ C$		327		ns
t_r	Rise Time			62		ns
$t_{d(off)}$	Turn-Off Delay Time			326		ns
t_f	Fall Time			175		ns
E_{on}	Turn-On Switching Loss			5.45		mJ
E_{off}	Turn-Off Switching Loss			7.69		mJ
C_{ies}	Input Capacitance	$V_{CE}=30V, f=1MHz,$ $V_{GE}=0V$		12.8		nF
C_{oes}	Output Capacitance			0.46		nF
C_{res}	Reverse Transfer Capacitance			0.32		nF
Q_G	Gate Charge	$V_{CC}=600V, I_C=100A,$ $V_{GE}=0-15V$		605		nC
I_{SC}	SC Data	$t_p \leq 10\mu s, V_{GE}=15V,$ $T_j=125^\circ C, V_{CC}=900V,$ $V_{CEM} \leq 1200V$		890		A
L_{CE}	Stray Inductance			21		nH
$R_{CC'+EE'}$	Module Lead Resistance, Terminal To Chip			1.80		m Ω

Electrical Characteristics of Diode $T_C=25^\circ C$ unless otherwise noted

Symbol	Parameter	Test Conditions	Min.	Typ.	Max.	Units
V_F	Diode Forward Voltage	$I_F=100A$	$T_j=25^\circ C$	1.80	2.20	V
			$T_j=125^\circ C$	1.85		
Q_r	Recovered Charge	$I_F=100A,$	$T_j=25^\circ C$	8.3		μC
			$T_j=125^\circ C$	11.8		
I_{RM}	Peak Reverse Recovery Current	$V_R=600V,$ $R_G=5.1\Omega,$	$T_j=25^\circ C$	116		A
			$T_j=125^\circ C$	136		
E_{rec}	Reverse Recovery Energy	$V_{GE}=-15V$	$T_j=25^\circ C$	3.98		mJ
			$T_j=125^\circ C$	7.93		

Electrical Characteristics of NTC $T_C=25^\circ\text{C}$ unless otherwise noted

Symbol	Parameter	Test Conditions	Min.	Typ.	Max.	Units
R_{25}	Rated Resistance			5.0		$\text{k}\Omega$
$\Delta R/R$	Deviation of R_{100}	$R_{100}=493.3\Omega$	-5		5	%
P_{25}	Power Dissipation				20.0	mW
$B_{25/50}$	B-value	$R_2=R_{25}\exp[B_{25/50}(1/T_2-1/(298.15\text{K}))]$		3375		K

Thermal Characteristics

Symbol	Parameter	Typ.	Max.	Units
$R_{\theta JC}$	Junction-to-Case (per IGBT)		0.259	K/W
$R_{\theta JC}$	Junction-to-Case (per Diode)		0.384	K/W
$R_{\theta CS}$	Case-to-Sink (Conductive grease applied)	0.009		K/W
Weight	Weight of Module	300		g

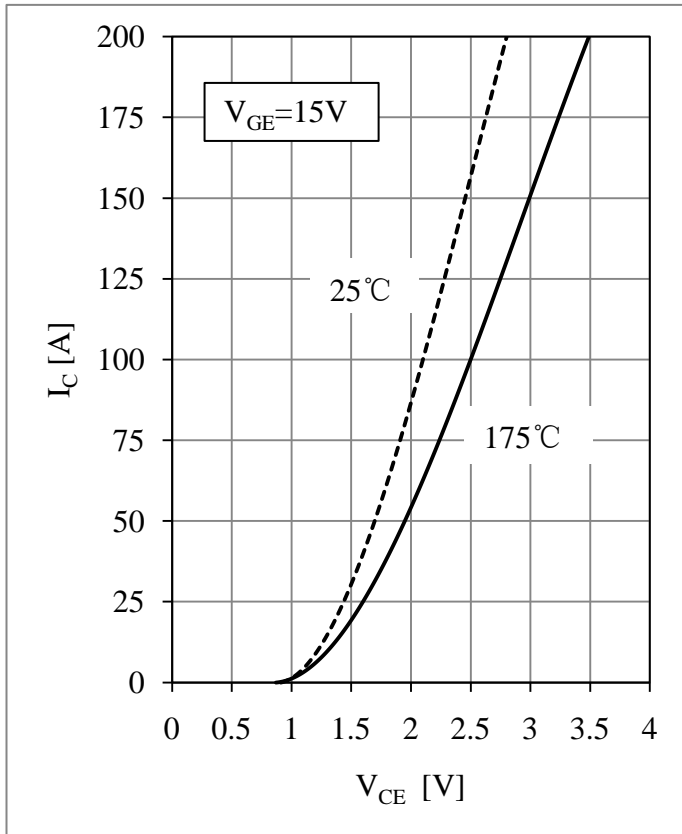

Fig 1. IGBT Output Characteristics

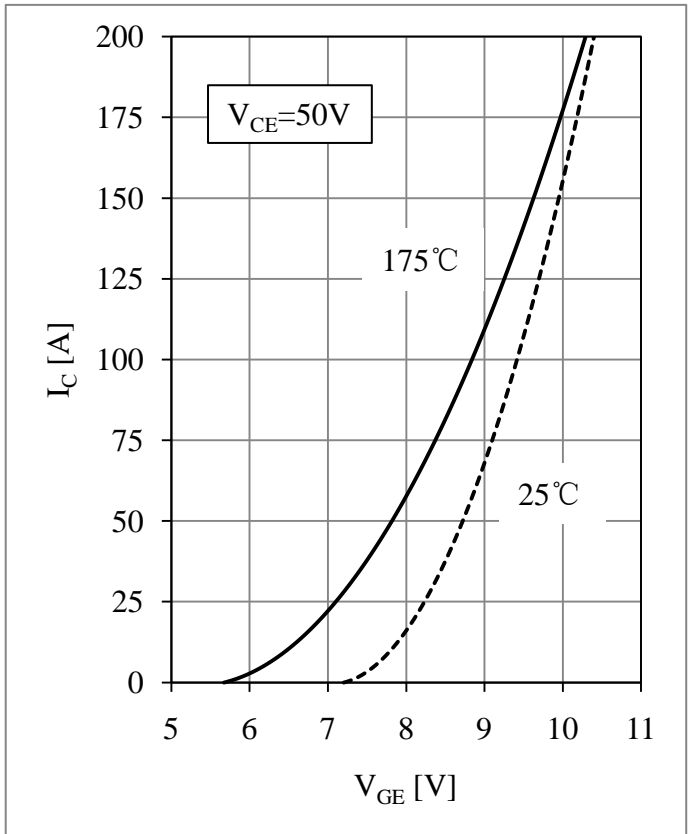

Fig 2. IGBT Transfer Characteristics

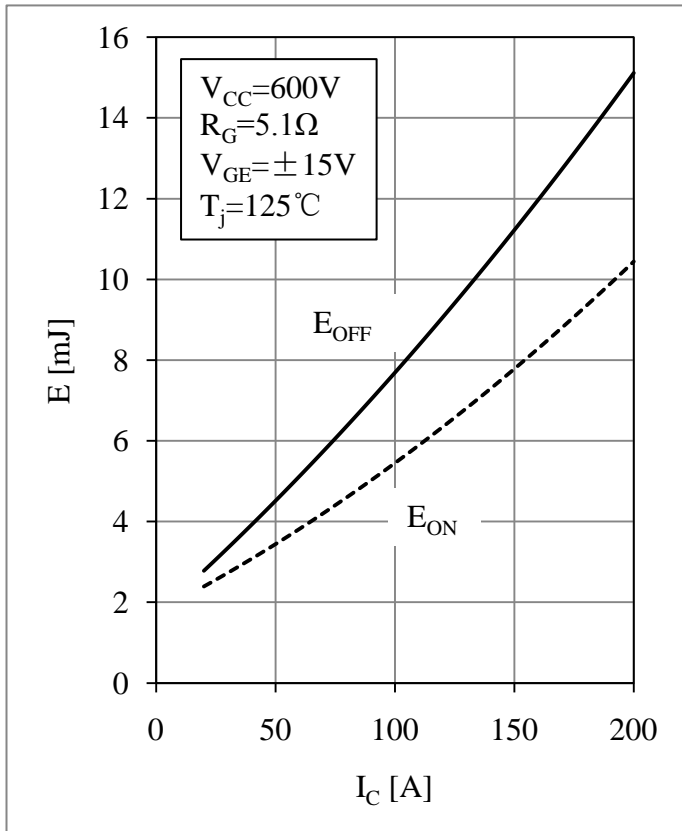

Fig 3. IGBT Switching Loss vs. I_C

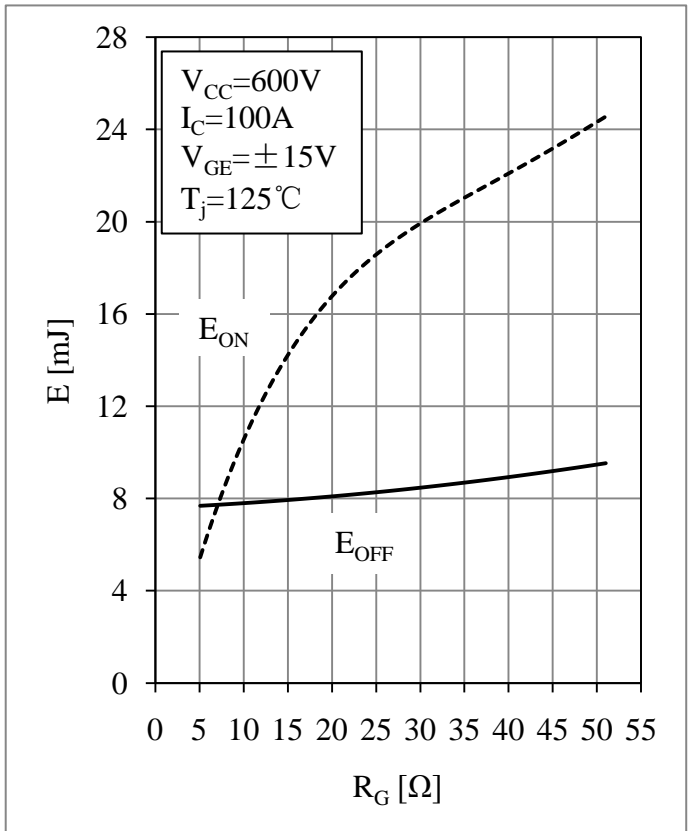

Fig 4. IGBT Switching Loss vs. R_G

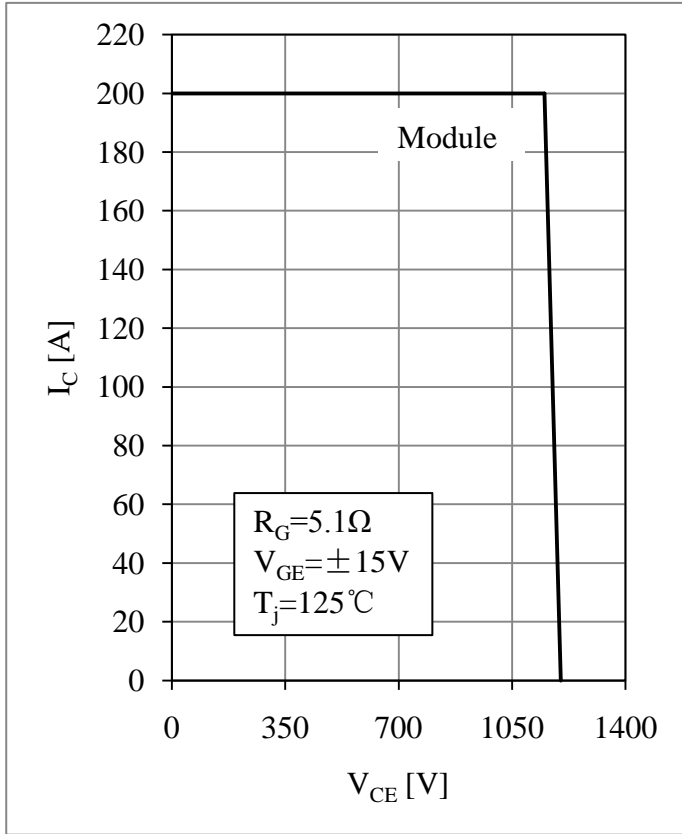

Fig 5. RBSOA

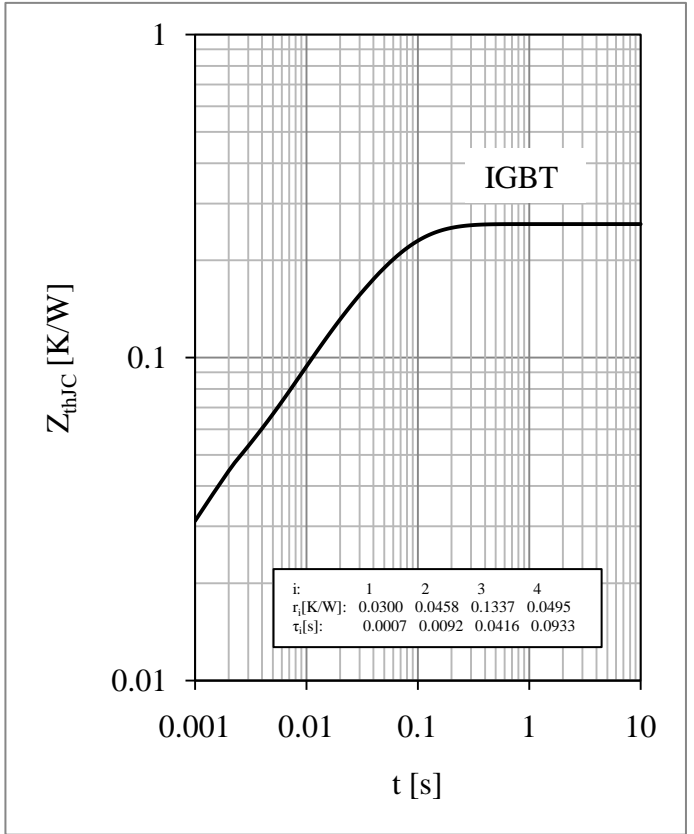

Fig 6. IGBT Transient Thermal Impedance

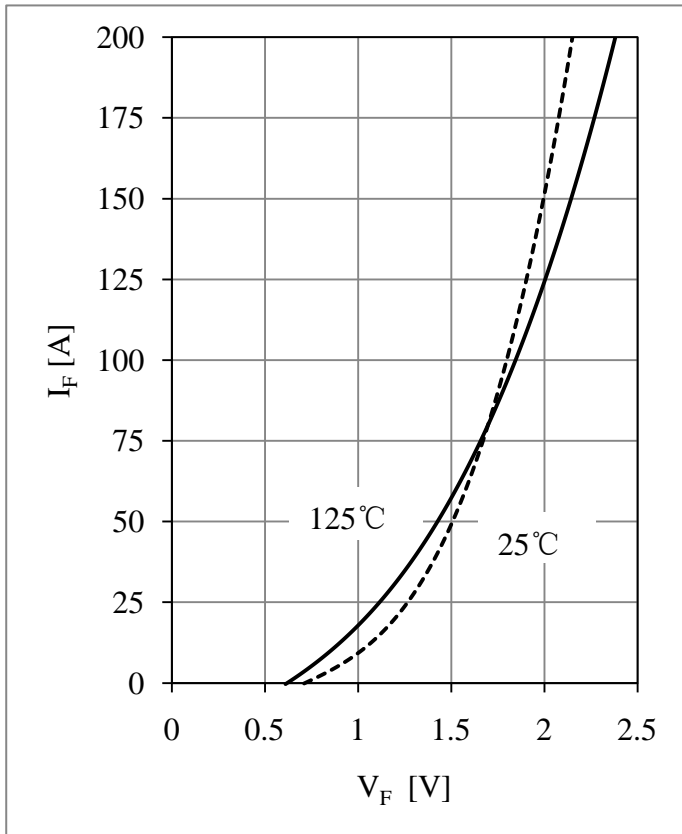

Fig 7. Diode Forward Characteristics

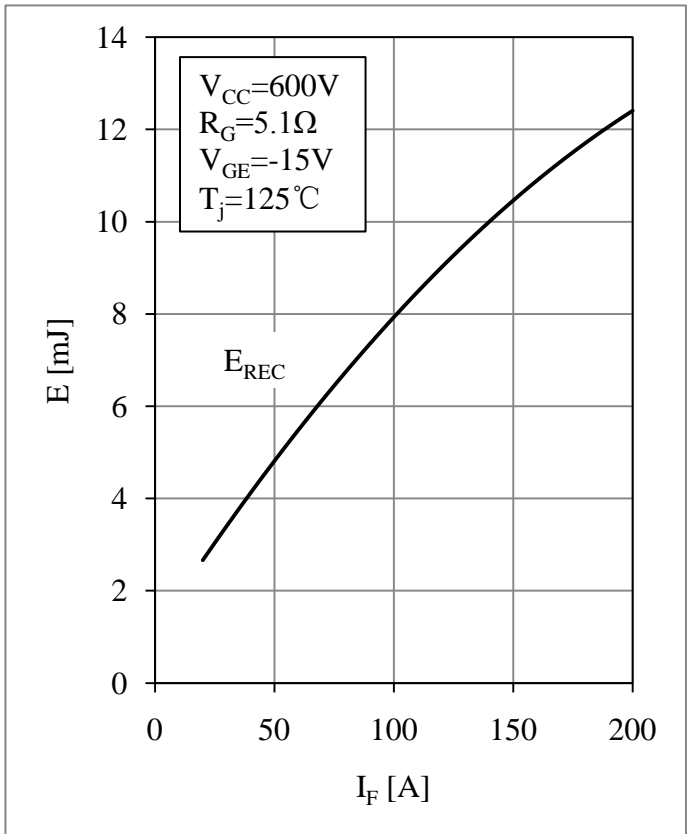

Fig 8. Diode Switching Loss vs. I_F

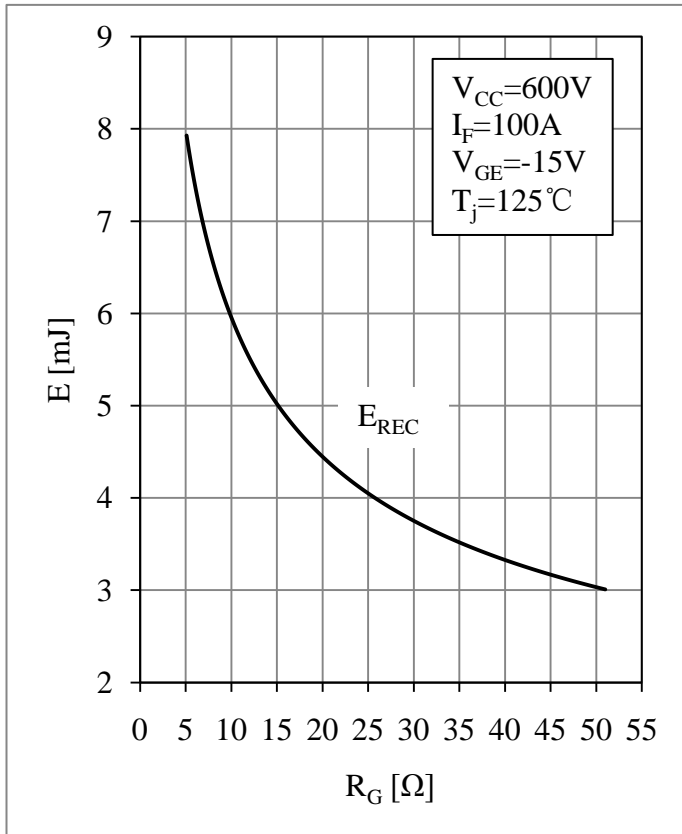

Fig 9. Diode Switching Loss vs. R_G

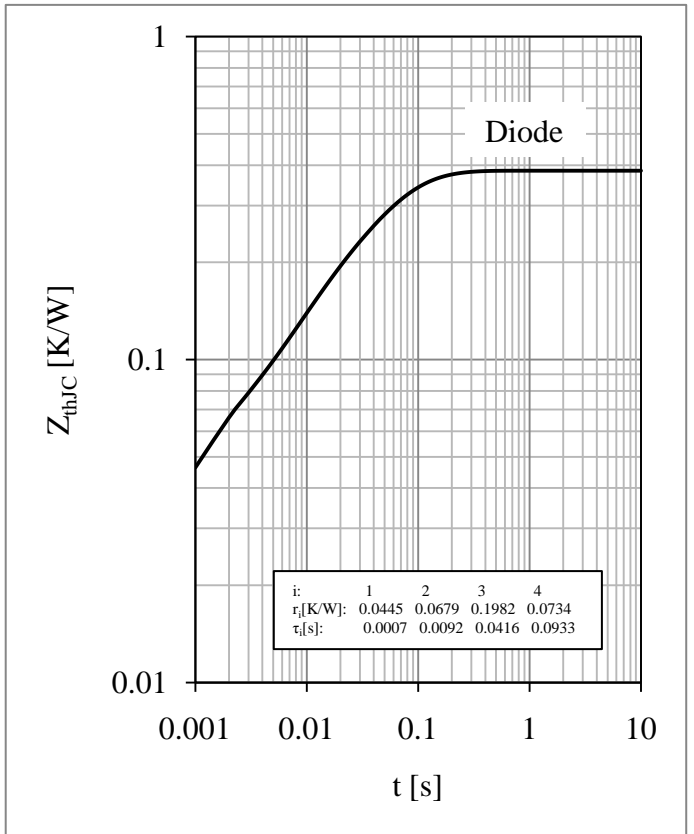

Fig 10. Diode Transient Thermal Impedance

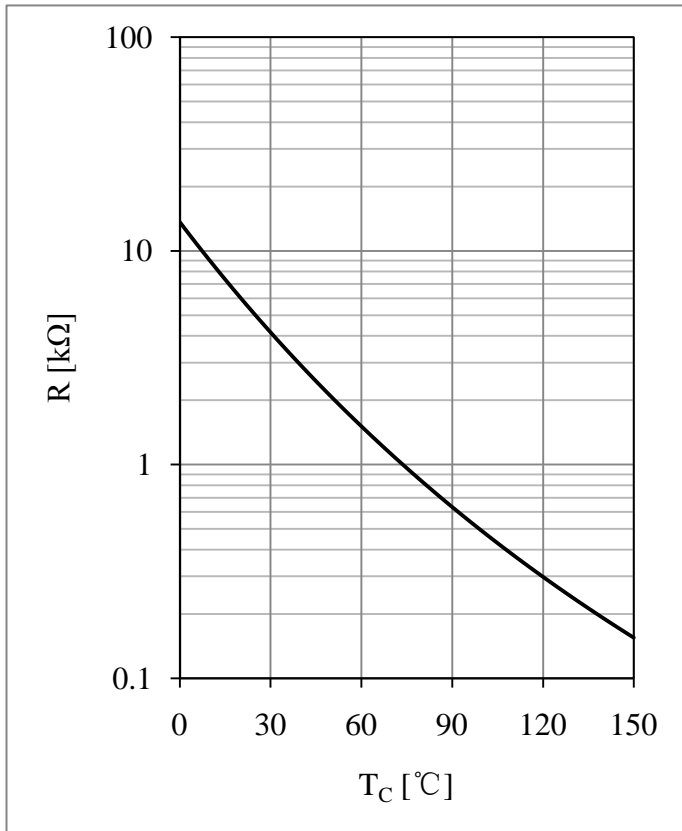
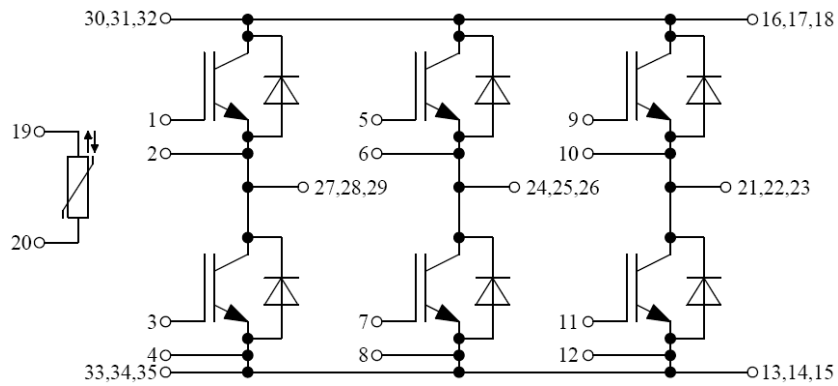

Fig 11. NTC-Temperature Characteristic

Equivalent Circuit Schematic



Package Dimensions

Dimensions in Millimeters

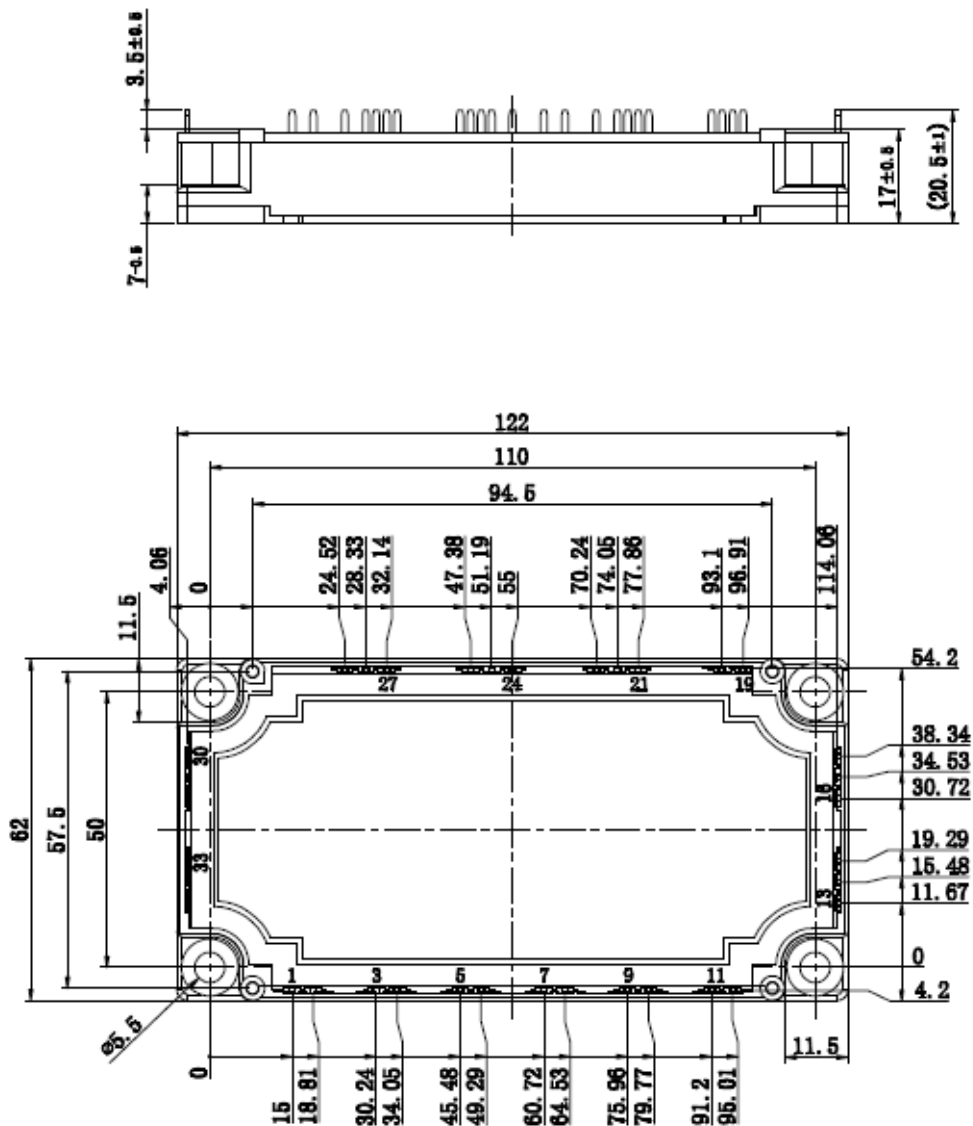

Terms and Conditions of Usage

The data contained in this product datasheet is exclusively intended for technically trained staff. you and your technical departments will have to evaluate the suitability of the product for the intended application and the completeness of the product data with respect to such application.

This product data sheet is describing the characteristics of this product for which a warranty is granted. Any such warranty is granted exclusively pursuant the terms and conditions of the supply agreement. There will be no guarantee of any kind for the product and its characteristics.

Should you require product information in excess of the data given in this product data sheet or which concerns the specific application of our product, please contact the sales office, which is responsible for you (see www.powersemi.cc), For those that are specifically interested we may provide application notes.

Due to technical requirements our product may contain dangerous substances. For information on the types in question please contact the sales office, which is responsible for you.

Should you intend to use the Product in aviation applications, in health or live endangering or life support applications, please notify.

If and to the extent necessary, please forward equivalent notices to your customers.
Changes of this product data sheet are reserved.