

STARPOWER

SEMICONDUCTOR

FRED

FD200HFH120C1S

Molding Type Module

1200V/200A 2 in one-package

General Description

STARPOWER Diode Power Module provides low forward voltage as well as low reverse recovery loss. They are designed for the applications such as SMPS.

Features

- Fast soft diode
- Low forward voltage drop
- Small temperature coefficient
- Low reverse recovery losses
- High ruggedness
- Low inductance
- Isolated copper baseplate using DBC technology



Typical Applications

- SMPS
- PFC
- Electric welders
- DC choppers

Equivalent Circuit Schematic

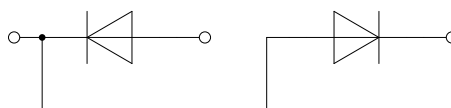

Absolute Maximum Ratings $T_C=25^{\circ}\text{C}$ unless otherwise noted

Symbol	Description	Value	Unit
V_{RRM}	Repetitive Peak Reverse Voltage	1200	V
I_F	Continuous Forward Current	200	A
I_{FRM}	Repetitive Peak Forward Current	400	A
P_D	Maximum Power Dissipation @ $T_j=150^{\circ}\text{C}$	771	W
T_{jmax}	Maximum Junction Temperature	150	$^{\circ}\text{C}$
T_{jop}	Operating Junction Temperature	-40 to +125	$^{\circ}\text{C}$
T_{STG}	Storage Temperature Range	-40 to +125	$^{\circ}\text{C}$
V_{ISO}	Isolation Voltage RMS, $f=50\text{Hz}, t=1\text{min}$	2500	V

Electrical Characteristics of Diode $T_C=25^{\circ}\text{C}$ unless otherwise noted

Symbol	Parameter	Test Conditions	Min.	Typ.	Max.	Unit
V_F	Diode Forward Voltage	$I_F=200\text{A}, T_j=25^{\circ}\text{C}$		1.82	2.27	V
		$I_F=200\text{A}, T_j=125^{\circ}\text{C}$		1.95		
Q_r	Recovered Charge	$I_F=200\text{A}, V_R=600\text{V}$ $-di/dt=3200\text{A}/\mu\text{s}$ $T_j=25^{\circ}\text{C}$		25.2		μC
I_{RM}	Peak Reverse Recovery Current			196		A
E_{rec}	Reverse Recovery Energy			8.5		mJ
Q_r	Recovered Charge	$I_F=200\text{A}, V_R=600\text{V}$ $-di/dt=3200\text{A}/\mu\text{s}$ $T_j=125^{\circ}\text{C}$		33.6		μC
			I_{RM}	Peak Reverse Recovery Current		236
E_{rec}	Reverse Recovery Energy			14.5		mJ

Thermal Characteristics

Symbol	Parameter	Min.	Typ.	Max.	Unit
L_{CE}	Stray Inductance			30	nH
$R_{CC'+EE'}$	Module Lead Resistance, Terminal to Chip		0.75		m Ω
R_{thJC}	Junction-to-Case (per Diode)			0.162	K/W
R_{thCH}	Case-to-Heatsink (per Module)		0.050		K/W
M	Terminal Connection Torque, Screw M5	2.5		5.0	N.m
	Mounting Torque, Screw M6	3.0		5.0	
G	Weight of Module		150		g

Equivalent Circuit Schematic

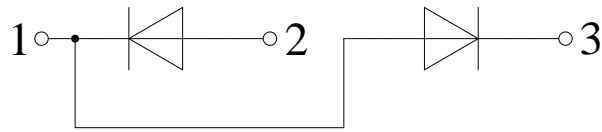

Package Dimensions

Dimensions in Millimeters

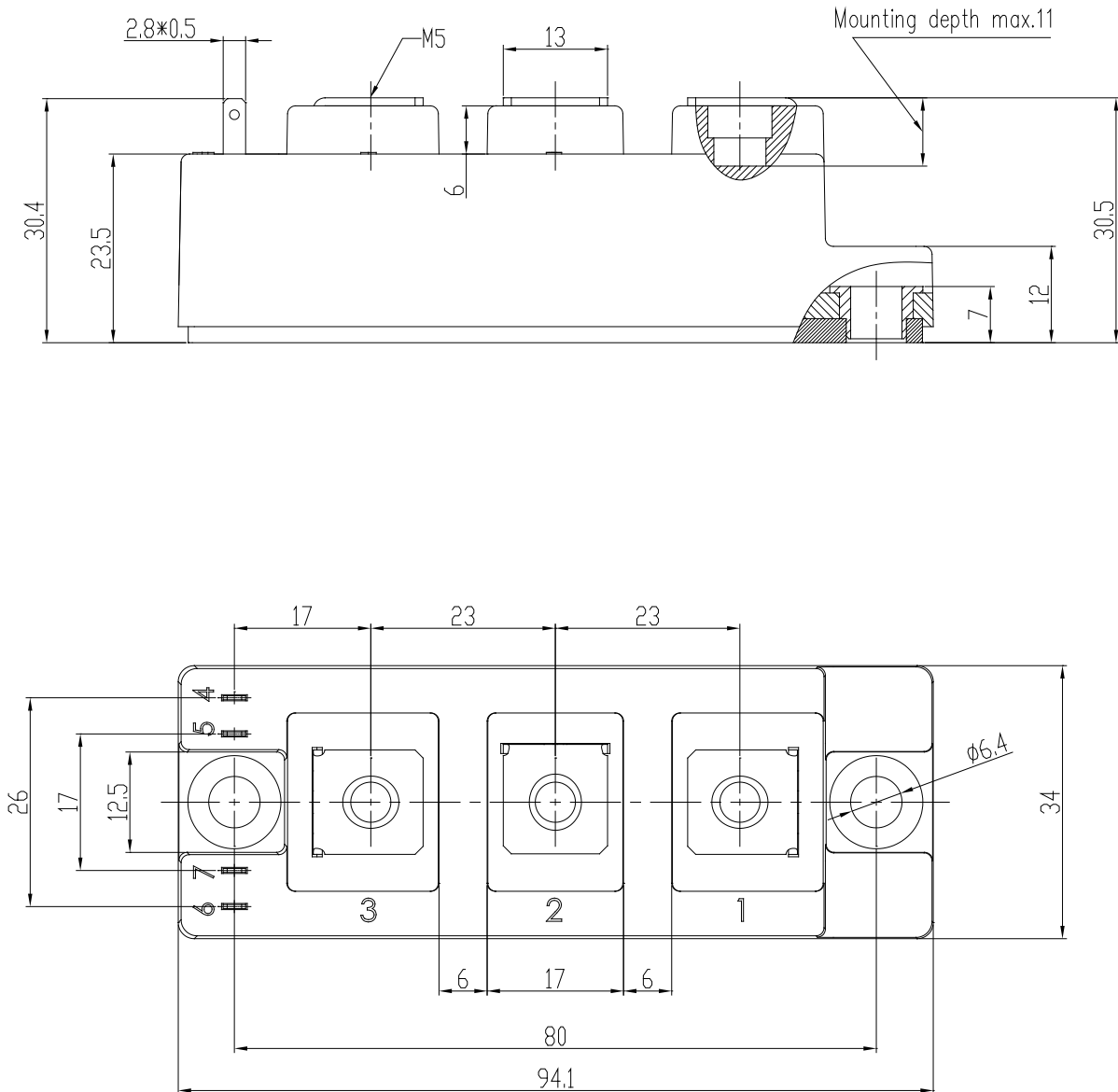

Terms and Conditions of Usage

The data contained in this product datasheet is exclusively intended for technically trained staff. you and your technical departments will have to evaluate the suitability of the product for the intended application and the completeness of the product data with respect to such application.

This product data sheet is describing the characteristics of this product for which a warranty is granted. Any such warranty is granted exclusively pursuant the terms and conditions of the supply agreement. There will be no guarantee of any kind for the product and its characteristics.

Should you require product information in excess of the data given in this product data sheet or which concerns the specific application of our product, please contact the sales office, which is responsible for you (see www.powersemi.cc), For those that are specifically interested we may provide application notes.

Due to technical requirements our product may contain dangerous substances. For information on the types in question please contact the sales office, which is responsible for you.

Should you intend to use the Product in aviation applications, in health or live endangering or life support applications, please notify.

If and to the extent necessary, please forward equivalent notices to your customers.
Changes of this product data sheet are reserved.